



## YB110/YB230 FIREYE® BurnerLogix™

**MICROPROCESSOR-BASED  
INTEGRATED BURNER  
MANAGEMENT CONTROL**



### DESCRIPTION

The Fireye® BurnerLogix™ System is a microprocessor based burner management control system designed to provide the proper burner sequencing, ignition and flame monitoring protection on automatically ignited oil, gas, and combination fuel burners. In conjunction with limit and operating controls, it programs the burner/blower motor, ignition and fuel valves to provide for proper and safe burner operation. Through SMART LED'S, the control provides current operating status and lockout information in the event of a safety shutdown. Optional VFD and LCD displays are available that may be either plugged in or mounted remotely to give full language descriptors of current status and diagnostic lockout information. Refer to BurnerLogix PROGRAMMER SELECTION later in this document for the various combinations of programmer and display modules.

A complete BurnerLogix system includes the YB110 (YB230) chassis equipped with the type of flame amplifier required for the application, appropriate flame detector, plug-in programmer module, wiring base and optional alpha-numeric display. Interchangeable programmer modules allow for complete versatility in selection of function, timing and flame failure response times.

The optional alpha-numeric display has 2 lines by 16 characters per line. It is available in either vacuum fluorescent or liquid crystal formats. The advantage of VFD is high brightness and extended temperature range down to -40°F. Both displays contain a fully functional keypad. You can easily scroll through the various menus to view the current operating status, review programmer configuration, and lockout history. When mounted remotely, the displays provide NEMA 4x(IP66) protection. An advantage of the BurnerLogix control family is the ability to set many of the operating parameters associated with proper and reliable burner operation allowing inventory of various programmer types to be kept to a minimum.

The YB110 (YB230) is a chassis/flame amplifier module complete with mounting screws and blank display module. The display module (BLV512 (vfd) or BLL510 (lcd)), if required, must be ordered separately. Interchangeable YP programmer modules allow for complete versatility in selection of control function, timing, and flame scanning means. Functions such as pre-purge time, recycling or non-recycling interlocks, high fire proving interlock, and trial for ignition timing of the pilot and main flame are determined by the programmer module. The BurnerLogix system can be used with ultra-violet, auto-check infrared, flame rod, self-check ultra-violet flame scanners or direct coupled integrated scanners by choosing the proper chassis/flame amplifier module.



Wiring bases for the BurnerLogix control are available pre-wired with 4 foot (1.2m) lead wires color coded and marked for easy installation or with an integral terminal block capable of accepting up to 2 X 14 AWG wires. The wiring base terminal block is available with knockouts for conduit or open ended for cabinet mounting. The pigtail wiring base is 4" X 5" (101.6mm x 127mm) and the terminal block wiring base is 4" X 7" (101.6mm x 177.8mm).

Additional functions of the BurnerLogix system include:

- A non-volatile memory allows the control to remember its history and present position even when power is interrupted.
- A consistent flame signal read-out via display module or 4-20 mA output.
- Read-out of main fuel operational hours and complete cycles via display module.
- Modbus communications via RS485 multi-drop link.
- Proof of fuel valve closure during the off cycle.
- Burn-in time of program parameters occurs after 8 hours of main valve on time.
- A run/check switch allows the operator to stop the program sequence in any of four different positions (Purge, PTFI, MTFI or Auto).
- Remote Display mounting with NEMA 4 protection.
- Remote Reset.
- Programmable communication baud rate allows for DCS compatibility.
- Keypad selectable language readout.
- Revert to pilot can increase burner turn down.
- Additional terminals provided for applications requiring additional inputs and outputs.

**CAUTION: While programmers are mechanically interchangeable in that they mate with a common chassis/amplifier module, you must select the correct model for your application. Inappropriate application of a control can result in an unsafe condition hazardous to life and property. Selection of a control for a particular application must be made by a competent professional, such as a boiler/burner service technician licensed by a state or other government agency.**

**NOTICE: This equipment generates and can radiate radio frequency energy, and if not installed and used in accordance with the instruction manual may cause interference to radio communications. It has been tested and found to comply with the limits for a Class A computing device pursuant to Subpart J of part 15 of FCC Rules, which are designed to provide reasonable protection against such interference when operated in a commercial environment. Operation of this equipment in a residential area may cause interference in which case the user, at his own expense, will be required to take whatever measures which may be required to correct the interference.**



## TABLE OF CONTENTS

BURNERLOGIX SPECIFICATIONS .....	5
PART NUMBERS AND APPROVALS .....	8
ORDERING INFORMATION .....	9
INSTALLATION PROCEDURE .....	13
WIRING BASE .....	13
PTFI*MTFI TIMINGS .....	17
LED INDICATOR LIGHTS .....	18
REPLACEABLE FUSE .....	19
DESCRIPTION OF FUNCTIONS OF OPERATING CONTROLS .....	20
SETTING PROGRAMMER PARAMETERS .....	20
KEYPAD DESCRIPTION .....	21
PROGRAM SET UP SUB-MENU .....	22
TO VIEW AND MODIFY A PROGRAMMABLE PARAMETER .....	23
FLAME SCANNERS .....	24
INSTALLATION - UV SCANNERS .....	24
OPERATION — 45UV5 & 55UV5 SELF-CHECKING UV SCANNER .....	25
WIRING - UV SCANNERS .....	26
INSTALLATION—INFRARED SCANNER TYPE 48PT2 .....	26
OPERATION - IR LEARN .....	27
INSTALLATION - 69ND1 FLAME ROD .....	29
INSTALLATION - 85 SERIES PHOENIX SCANNER .....	30
INSTALLATION - 95 SERIES INSIGHT SCANNERS .....	32
SYSTEM INFO SUB-MENU .....	35
SYSTEM OPERATION .....	35
YP100 OPERATING SEQUENCE .....	36
START-UP (NORMAL CYCLE) .....	37
YP200 OPERATING SEQUENCE .....	39
YP300 OPERATING SEQUENCE .....	40
YP138 PROGRAMMER .....	42
LOCKOUTS .....	46
SAFETY SHUTDOWN .....	46
DIAGNOSTIC MESSAGES .....	47
RESETTING THE CONTROL .....	47
LOCKOUT CODES .....	48
LOCKOUT HISTORY SUB-MENU .....	49
COMMUNICATIONS .....	50
MESSAGE FORMAT .....	50
MODBUS MESSAGE TABLE .....	51
INPUTS .....	52
OUTPUTS .....	52
EXPLANATION OF LOGSTAT .....	54
BURNERLOGIX MESSAGES .....	55
INTERLOCK ANNUNCIATOR .....	57
OPERATIONAL FEATURES .....	58
4-20 mA TEST JACKS .....	58
CHECK-RUN SWITCH .....	59
OPERATIONAL TEST .....	60
TEST CHECKOUT PROCEDURES .....	60
SUGGESTED GROUNDING RULES .....	62
MAINTENANCE .....	63



## Table of Figures

FIGURE 1.	BURNERLOGIX ORDERING INFORMATION	12
FIGURE 2.	WIRING BASE DETAILS	13
FIGURE 3.	YP110 PROGRAMMER	15
FIGURE 4.	KEYPAD DESCRIPTION	21
FIGURE 5.	BURNERLOGIX MENU STRUCTURE	21
FIGURE 6.	MAIN MENU	22
FIGURE 7.	FLAME SCANNERS	24
FIGURE 8.	AIMING YOUR SCANNER	24
FIGURE 9.	TYPICAL SCANNER INSTALLATIONS	25
FIGURE 10.	UV SELF CHECK SCANNER OPERATION	26
FIGURE 11.	SCANNER INSTALLATION	27
FIGURE 12.	PHOENIX WIRING DIAGRAM	30
FIGURE 13.	BURNERLOGIX TYB110DC/YB230DC WITH 85UVF4-1QDWR SCANNER	31
FIGURE 14.	INSIGHT WIRING DIAGRAM	33
FIGURE 15.	CONNECT BURNERLOGIX & INSIGHT I	34
FIGURE 16.	SYSTEM INFO SUB-MENU	35
FIGURE 17.	YP100 OPERATING SEQUENCE	36
FIGURE 18.	YP200 OPERATING SEQUENCE	39
FIGURE 19.	YP300 OPERATING SEQUENCE	40
FIGURE 20.	BURNERLOGIX WIRING DIAGRAM	41
FIGURE 21.	YP300 WIRING DIAGRAM	42
FIGURE 22.	YP138 WIRING DIAGRAM	43
FIGURE 23.	LOCKOUT HISTORY	49
FIGURE 24.	BOTTOM VIEW COMMS	50
FIGURE 25.	DEFAULT WIRING FOR YZ300 INTERLOCK ANNUNCIATOR	53
FIGURE 26.	BOTTOM VIEW 4-20 mA JACKS	58
FIGURE 27.	TEST JACKS (4-20 mA) VS. FLAME STRENGTH	58
FIGURE 28.	CHECK RUN SWITCH	59
FIGURE 29.	PILOT FLAME TEST	62

## Table of Tables

Table 1:	OPERATING TEMPERATURE LIMITS	5
Table 2:	LOAD RATINGS	6
Table 3:	AGENCY APPROVALS	8
Table 4:	APPLICABLE BULLETINS	9
Table 5:	ORDERING INFORMATION	9
Table 6:	PROGRAMMER MODULES	9
Table 7:	BURNERLOGIX DISPLAYS	10
Table 8:	BURNERLOGIX WIRING BASES	10
Table 9:	BURNERLOGIX ACCESSORIES	10
Table 10:	SCANNER SELECTION	10
Table 11:	PRE-WIRED WIRING BASE, P/N 60-2810-1 (shown for 120 VAC)	13
Table 12:	BURNERLOGIX PROGRAMMER SELECTION	16
Table 13:	PTFI & MTFI TIMING	18
Table 14:	LED INDICATORS	18
Table 15:	MODIFIABLE PARAMETERS LOCATED IN PROGRAM SETUP MENU	23
Table 16:	PHOENIX SCANNER CABLE COLOR CODE	31
Table 17:	DIAGNOSTIC MESSAGES	47
Table 18:	LED CODES	48
Table 19:	MESSAGE FORMAT	50
Table 20:	MODBUS	50
Table 21:	MODBUS MESSAGE TABLE	51
Table 22:	INPUTS AND OUTPUTS	52
Table 23:	YZ300	53
Table 24:	LOGSTAT	54
Table 25:	BURNERLOGIX MESSAGES	55
Table 26:	DIAGNOSTIC MESSAGES	56
Table 27:	ANNUNCIATOR MESSAGES	57



## ..BURNERLOGIX SPECIFICATIONS

### Supply Voltage:

**YB110** 120 VAC (+10%, -15%) 50/60 Hz

**YB230** 230 VAC (+10%, -15%) 50/60 Hz

### Power Consumption:

25 VA

### Temperature Rating:

-40°C (-40°F) to +60°C (140°F)

### Protection Category:

**YB110 (YB230)** control NEMA 1 (IP01)

Display, remote mounted NEMA 4X (IP66)

### Unit Dimensions:

Wiring base 60-2810-1 - 4.0" (101 mm) W x 5.0" (127mm) H

Wiring base 60-2812-1, 60-2814-1 - 4.0" (101 mm) W x 7.0" (178 mm) H

### Shipping Weight:

**YB110 (YB230)** Approx. 3.2 lbs. (1.45kg)

**Table 1: OPERATING TEMPERATURE LIMITS**

CONTROL	MAXIMUM		MINIMUM	
YB110, YB230	140°F	60°C	-40°F	-40°C
YP Programmers	140°F	60°C	-40°F	-40°C
BLV512, VFD Display	140°F	60°C	-40°F	-40°C
BLL510, LCD Display	140°F	60°C	-4°F	-20°C
Scanner UV1A, UV2, UV8A, UV90, 45UV3	200°F	93°C	-40°F	-40°C
45UV5-1005, 45UV5-1105 45UV5-1007, 45UV5-1009 55UV5-1007, 55UV5-1009	200°F	93°C	-40°F	-40°C
48PT2	140°F	60°C	-40°F	-40°C
Flame Rod (Tip 2460°F)	1500°F	816°C	-40°F	-40°C
Humidity: 90% R.H. (Non-condensing)				
Phoenix 85 Series	150°F	65°C	-40°F	-40°C
InSight 95 Series	150°F	65°C	-40°F	-40°C



**Table 2: LOAD RATINGS**

Terminal	Typical Load	A. Maximum Rating @120V-50/60 Hz	B. Maximum Rating @230V-50/60 Hz	C. Alternate Rating
M	Burner/Blower Motor	9.8 F.L.A. * 58 L.R.A.	4.0 F.L.A. * 20 L.R.A.	240 VA Pilot Duty (Motor Starter Coil)
10-11-12-X	Modulator	125 VA Pilot Duty		
A	Alarm	50 VA Pilot Duty		
Terminal ratings may be selected from either column A or C for 120 VAC or from either column B or C for 30 VAC: (select the rating from the column which best applies to the connected load on that terminal). * F.L.A. = full load amps; L.R.A = locked rotor amps				

**Combination of fuel and igniter terminals**

Combination No.	Pilot Fuel Trm 6	Main Trm 7	Ignition Trm 5	Delayed Valve Trm W
1	C	E	No Load	No Load
2	B	E	No Load	No Load
3	No Load	E	No Load	B
4	E	E	A	No Load
5	No Load	E	A	E
6	D	E	A	No Load
7	D	D	A	D
8	No Load	D	A	No Load

**Composition of each combination**

A	B	C	D	E
4.5A Ignition @120 VAC	50 VA Pilot Duty plus 4.5A ignition@ 120 VAC	180 VA Ignition plus motor valves with: 660 VA inrush, 360 VA open, 250 VA hold.	2A Pilot Duty @120 VAC	65 VA Pilot Duty plus Motor valves with: 700 VA open 250 VA hold.
2.2A Ignition @230 VAC	50 VA Pilot Duty plus 2.2A ignition @230 VAC		1A Pilot Duty @230 VAC	

**Maximum connected load must not exceed 2000 VA**

**ELECTRICAL RATINGS**

VA ratings (not specified as pilot duty) permit the connection of transformers and similar devices whose inrush current is approximately the same as their running current.

VA Pilot Duty ratings permit the connection of relays, solenoid valves, lamps, etc. whose total operating load does not exceed the published rating and whose total inrush current does not exceed 10 times the rating.

Running and locked rotor ratings are intended for motors. VA and VA Pilot Duty loads may be added to a motor load provided the total load does not exceed the published rating.



**CAUTION: Published load ratings assume that no contact will be required to handle inrush current more often than once in 15 seconds. Using control switches, solenoid, relays, etc. which chatter lead to premature failure. Run through a test operation (with fuel shut off) following the tripping of a circuit breaker, a blown fuse, or any known instance of chattering of any external current consuming devices.**

## APPROVALS

### Underwriters Laboratories Inc.:

MCCZ File MP1537  
Controls, Primary Safety - Listed  
MCCZ2 File MP1537  
Controls, Primary Safety - Component  
MCCZ7 File MP1537  
Controls, Primary Safety Certified for Canada  
MCCZ8 File MP1537  
Controls, Primary Safety Certified for Canada - Component

### Factory Mutual:

Approved

### Acceptable by:

Industrial Risk Insurers (I.R.I.)

### CE:





Gas Appliances  
Gas Appliance Directive: 90/396/EEC  
Low Voltage Directive: 73/23/EEC  
EMC Directive: 89/336/EEC  
GASTEC: 0063BT1754  
(EN298, 2003; EN230, 2005)



**NOTICE:** This equipment generates and can radiate radio frequency energy, and if not installed and used in accordance with the instruction manual may cause interference to radio communications. It has been tested and found to comply with the limits for a Class A computing device pursuant to Subpart J of part 15 of FCC Rules, which are designed to provide reasonable protection against such interference when operated in a commercial environment. Operation of this equipment in a residential area may cause interference in which case the user, at his own expense, is required to take whatever measures which may be required to correct the interference.

**PART NUMBERS AND APPROVALS**

**Table 3: AGENCY APPROVALS**

<b>BurnerLogix Chassis/Flame Amp. Module</b>				
YB110UV	X	X	X	
YB110UVSC	X	X	X	
YB110IR	X	X	X	X
YB110IR2	X	X	X	X
YB110FR	X	X	X	
YB110DC	X	X	X	
YB230UV	X			
YB230UVSC	X			
YB230IR	X			X
YB230IR2	X			X
YB230FR	X			
YB230DC	X			
<b>BurnerLogix Programmer Module</b>				
YP100	X	X	X	
YP102	X	X	X	
YP138	X	X	X	
YP118	X	X	X	
YP183	X	X	X	
YP200	X	X	X	
YP202	X	X	X	
YP300	X	X	X	
YP302	X	X	X	
YP113	X	X	X	X
YP115	X	X	X	X
<b>BurnerLogix Displays</b>				
BLV512	X	X	X	X
BLL510	X	X	X	X
<b>BurnerLogix Wiring Bases</b>				
60-2810-1	X	X		X
60-2812-1	X		X	X
60-2814-1	X		X	X

**X = CERTIFICATION IN HAND**





**Table 4: APPLICABLE BULLETINS**

Programmers, Non-recycle Operation	YP-1001
Programmers, Recycle Operation	
Programmers, Non-modulating	
Displays	BD-5001
Wiring base installation, 60-2810-1	133-676
Wiring base installation, 60-2812-1	133-677
Wiring base installation, 60-2814-1	133-677

**Table 5: ORDERING INFORMATION**

BurnerLogix Chassis/Flame Amplifier Module	
YB110UV	120 VAC input with UV non self-check amplifier
YB110UVSC	120 VAC input with UV self-check amplifier
YB110IR	120 VAC input with IR auto-check amplifier
YB110IR2	120 VAC input with IR auto-check amplifier (special application only -consult factory)
YB110FR	120 VAC input with flame rectification amplifier
YB110DC	120 VAC input with direct coupled amplifier
YB230UV	230 VAC input with UV non self-check amplifier
YB230UVSC	230 VAC input with UV self-check amplifier
YB230IR	230 VAC input with IR auto-check amplifier
YB230IR2	230 VAC input with IR auto check (special application only-consult factory)
YB230FR	230VAC input with flame rectification amplifier
YB230DC	230VAC input with direct coupled amplifier

**Table 6: PROGRAMMER MODULES**

BurnerLogix Programmer Modules	
YP100	Keypad selectable parameters, non-recycle operation, modulation, open damper proving, 4 second FFRT
YP102	Keypad selectable parameters, non-recycle operation, modulation, open damper proving, 2 second FFRT
YP113	Keypad selectable parameters, non-recycle operation, modulation, open damper proving, 1 second FFRT
YP115	Keypad selectable parameters, non-recycle operation, modulation, open damper proving, 1 second FFRT
YP118	Keypad selectable parameters, non-recycle operation, modulation, open damper proving, indefinite pilot hold, revert to pilot from auto, 1 second FFRT
YP138	Keypad selectable parameters, non-recycle operation, modulation, open damper proving, voltage on terminal 16 is indefinite pilot hold during lightoff, applied voltage on term 16 is revert to pilot from auto, 4 second FFRT
YP183	Same as YP138, except, removal of voltage on terminal 16 will suspend pilot hold during lightoff sequence. Terminal W used for purge complete.
YP200	Keypad selectable parameters, recycle operation, modulation, 4 second FFRT
YP202	Keypad selectable parameters, recycle operation, modulation, 2 second FFRT
YP300	Keypad selectable parameters, recycle operation, low fire start, early spark termination, 4 second FFRT
YP302	Keypad selectable parameters, recycle operation, low fire start, early spark termination, 2 second FFRT

*Note: All programmers: when used with the YB110DC or YB230DC, the FFRT is 0.2 seconds*



**Table 7: BURNERLOGIX DISPLAYS**

BurnerLogix Displays	
BLV512	Display, 2 line X 16 characters, VFD, with cable, NEMA 4
BLL510	Display, 2 line X 16 characters, LCD, with cable, NEMA 4

**Table 8: BURNERLOGIX WIRING BASES**

BurnerLogix wiring bases	
60-2810-1	Pigtail wires, 4 foot long, 4"W x 5"H
60-2812-1	Closed base with terminal block and knockouts, 4"W x 7"H
60-2814-1	Open base with terminal block. 4"W x 7"H

**Table 9: BURNERLOGIX ACCESSORIES**

BurnerLogix Accessories	
129-178-4	Kit, remote mounting, BurnerLogix display, 4 ft. cable, provides NEMA 4 protection
129-178-8	Kit, remote mounting, BurnerLogix display, 8 ft. cable, provides NEMA 4 protection
BLD500	Blank display module, included with YB module
IT1000	Alarm annunciation system using wireless technology
PPC6000	Parallel Positioning System
61-5745-3	Shutter drive assembly for redundant self-check scanners

**Table 10: SCANNER SELECTION**

FIREYE P/N	DESCRIPTION	USE WITH CHASSIS	BULLETIN
48PT2-1003	Infrared 1/2" straight mount 96"(2438mm) TC-ER cable	YB110IR YB230IR YB110IR2 YB230IR2	SC-103
48PT2-9003	Infrared 1/2" 90° angle mount 96" (2438mm) TC-ER cable		
48PT2-1007	Infrared 1/2" straight mount 48" (1219mm) TC-ER cable		
48PT2-9007	Infrared 1/2" 90° angle mount 48" (1219mm) TC-ER cable		
4-263-1	Replacement photo detector		
UV1A3	UV 1/2" straight 36" (915mm) TC-ER cable	YB110UV YB230UV	SC-102
UV1A6	UV 1/2" straight 72" (1830mm) TC-ER cable		
UV8A	UV 1/2" 90° head 72" (1830mm) no armor flex		
UV2	UV 3/8" straight 36"(915mm) TC-ER cable		
UV2A6	UV 3/8" straight 72" (1830mm) TC-ER cable		
45UV3-1050	UV 3/4" cast aluminum housing 96" (2438mm) unshielded leads		
UV90-3	UV 90° lateral view with 36" (915mm) flex conduit		
UV90-6	UV 90° lateral view with 72" (1830mm) flex conduit		
UV90-9	UV 90° lateral view with 108" (2745mm) flex conduit		
45UV5-1007	Self-check UV 1" BSP threads, 102-264VAC	YB110UVSC YB230UVSC	SC-101
45UV5-1009	Self-check UV 1" NPT threads, 102-264VAC		
4-314-1	Replacement UV tube		
69ND1-1000K4	Flame rod, 12", 1/2" mount	YB110FR YB230FR	SC-103
69ND1-1000K6	Flame rod, 18", 1/2" mount		
69ND1-1000K8	Flame rod, 24", 1/2" mount		
45UV5-1005	Self-check UV 1" NPT threads, 61-5745-3 required	YB110UVSC YB230UVSC	133-645
45UV5-1105	Self-check UV 1" BSP threads, 61-5745-3 required		
55UV5-1007	Self-check UV 1" BSP, 102-264VAC, Suitable for hazardous locations.	YB110UVSC YB230UVSC	SC-106
55UV5-1009	Self-check UV 1" NPT, 102-264VAC, Suitable for hazardous locations.		
<b>PHOENIX</b>			



**Table 10: SCANNER SELECTION (Continued)**

FIREYE P/N	DESCRIPTION	USE WITH CHASSIS	BULLETIN
85UVF4-1QDWR	Phoenix Integrated Scanner, 4 sec FFRT – Ultra-violet with 8-pin electrical quick disconnect. FM, UL_CUS approved.		
85UVF4-2QDWR	Fiber optic version of standard Phoenix Integrated Scanner, 4 sec FFRT – Ultra-violet with 8-pin electrical quick disconnect. FM, UL_CUS approved.		
85IRF4-1QDWR	Phoenix Integrated Scanner, 4 sec FFRT – Infrared with 8-pin electrical quick disconnect. FM, UL_CUS approved.		
85IRF4-2QDWR	Fiber optic version of standard Phoenix Integrated Scanner, 4 sec FFRT – Infrared with 8-pin electrical quick disconnect. FM, UL_CUS approved.		
35-318-1	Mounting flange for Phoenix, 1" NPT	YB110DC	CU-114
35-318-2	Mounting flange for Phoenix, 1" BSP		
59-546-3	8-Conductor 3-meter (9 ft. 10 in.) cable assembly with 8-pin female connector.	YB230DC	
59-546-6	8-Conductor 6-meter (19 ft. 8 in.) cable assembly with 8-pin female connector.		
59-546-9	8-Conductor 9-meter (29 ft. 3 in.) cable assembly with 8-pin female connector.		
59-546-12	8-Conductor 12-meter (39 ft. 4 in.) cable assembly with 8-pin female connector.		
59-546-15	8-Conductor 15-meter (49 ft. 2 in.) cable assembly with 8-pin female connector.		
59-546-30	8-Conductor 30-meter (98 ft. 5 in.) cable assembly with 8-pin female connector.		
59-546-45	8-Conductor 45-meter (147 ft. 7 in.) cable assembly with 8-pin female connector.		
59-546-60	8-Conductor 60-meter (196 ft. 10 in.) cable assembly with 8-pin female connector.		
59-546-90	8-Conductor 90-meter (295 ft. 3 in.) cable assembly with 8-pin female connector.		
<b>INSIGHT</b>			
95IRS2-1, 2	Enhanced Model InSight Scanner – Infrared with quick disconnect, FM, UL_CUS approved.		
95UVS2-1, 2, 3	Enhanced Model InSight Scanner – Ultra-violet with quick disconnect, FM, UL_CUS approved.		
95DSS2-1	Enhanced Model InSight Scanner – Dual detector with quick disconnect, FM, UL_CUS approved.		
60-2692	1" NPT mounting flange for InSight Scanner, includes heat insulator 35-127-1.	YB110DC	CU-95
60-2693	1" BSP mounting flange for InSight Scanner, includes heat insulator 35-127-3.		
59-497-020-WR	12-Conductor cable with straight connector (129-164), 20 feet(6 meter)		
59-497-020C-WR	12-Conductor cable with straight connector (129-164C) and flex conduit adapter, 20 feet(6 meter)		
59-497-020R-WR	12-Conductor cable with right angle connector (129-164R), 20 feet(6 meter)		
59-497-020RC-WR	12-Conductor cable with right angle connector (129-164RC) and flex conduit adapter, 20 feet(6 meter)		
<b>POWER SUPPLIES</b>			
60-2685-25	Power Supply, 24 VDC, 2.0A, 120/240 VAC, 50/60Hz		CU-118
60-2685-50	Power Supply, 24 VDC, 4.0A, 120/240 VAC, 50/60Hz		

**FIGURE 1. BURNERLOGIX ORDERING INFORMATION**

**CHASSIS/AMPLIFIER**

120 VAC, 50/60 Hz  
 YB110UV  
 YB110UVSC  
 YB110IR  
 YB110FR  
 YB110DC

230 VAC, 50/60 Hz  
 YB230UV  
 YB230 UVSC  
 YB230IR



FRONT VIEW  
(WITH OPTIONAL DISPLAY INSTALLED)



SIDE VIEW  
(WITH OPTIONAL PROGRAMMER AND DISPLAY INSTALLED)

**PROGRAMMER MODULE**

YP100  
 YP102  
 YP200  
 YP202  
 YP300  
 YP302  
 YP113  
 YP138  
 YP118



**DISPLAY MODULE**

BLV512 - VACUUM FLUORESCENT  
 BLL510 - LIQUID CRYSTAL

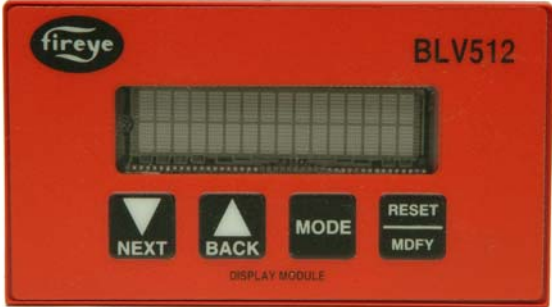

**WIRING BASE**

60-2814-1  
 OPEN BOTTOM  
 CABINET MOUNT

60-2812-1  
 CLOSED BOTTOM  
 CONDUIT KNOCKOUT



60-2814-1 SHOWN

**WIRING BASE**

60-2810-1  
 PRE-WIRED  
 4 FOOT  
 COLOR CODED



***NOTE:** The Phoenix QDWR models with electrical quick-disconnect have replaced the original WR models equipped with ten feet of captive cable. The QDWR models (with 59-546-X cables) are also suitable for use in Class I Division 2 hazardous areas, thereby eliminating the need for the "EXWR" models.*

## INSTALLATION PROCEDURE

### WIRING BASE

Select either the pre-wired wiring base (60-2810-1) or terminal block style (60-2812-1, 60-2814-1). Either wiring base type can be mounted on a din rail or directly mounted to the cabinet back plate. Refer to Figure 2 for mounting dimensions.

**FIGURE 2. WIRING BASE DETAILS**

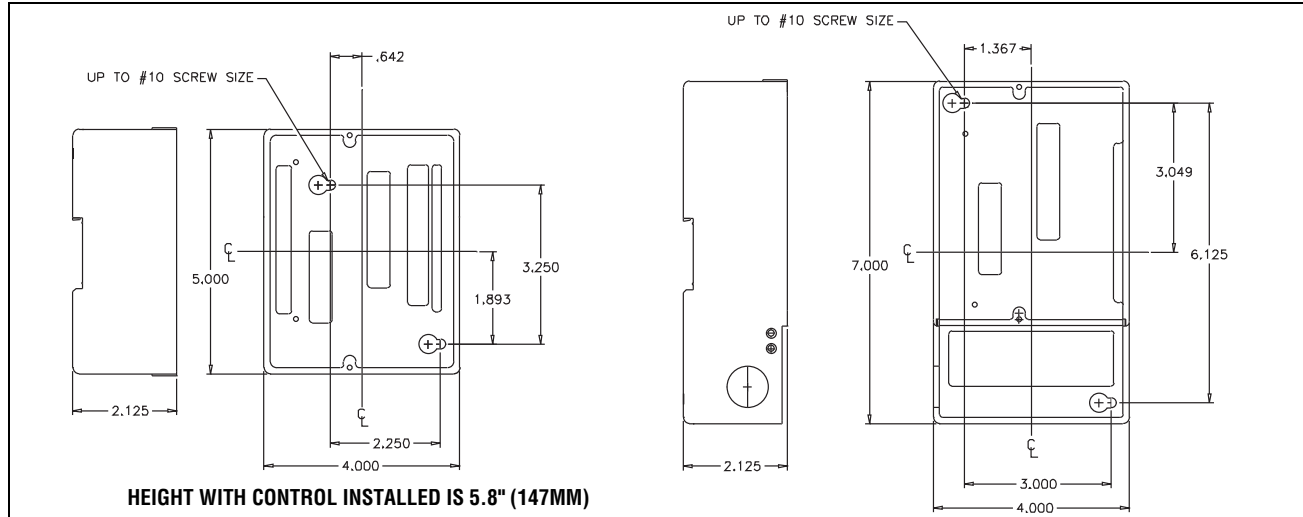

The location should be free from excessive vibration and within the ambient temperature rating.

**Table 11: PRE-WIRED WIRING BASE, P/N 60-2810-1 (shown for 120 VAC)**

Terminal No.	Wire Color	Type	Description	Rating
L1 (Hot)	Black		Line voltage supply	120/230 VAC (+10%,-15%), 50/60 Hz
L2 (Neutral)	White		Line voltage common	
EARTH	Green	Ground		
S1	Red/Wht		Scanner Input	300 VAC, 3 mA (UV models only)
S2	Blu/Wht		Scanner Input	300 VAC, 3 mA (UV models only)
A	Red	Output	Alarm	120/230 VAC, 1 A pilot duty
M	Brown	Output	Combustion Blower	120/230 VAC, 9.8 FLA, 58.8 LRA
3	Yellow	Input	Operating Control	120/230 VAC, 1 mA
13	Orange	Input	Fuel Valve End Switch, Pre-Ignition Interlock	120/230 VAC, 1 mA
P	Gray	Input	Running Interlock	120/230 VAC, 1 mA
D	Wht/Brn	Input	Low Fire Start Switch	120/230 VAC, 1 mA
8	Wht/Gry	Input	Open Damper Proving Switch	120/230 VAC, 1 mA
W	Wht/Orn	Output	Delayed Main Valve	See Load Ratings (Page 7)
5	LT Blue	Output	Ignition / Pilot Valve	See Load Ratings (Page 7)
6	Tan	Output	Pilot Valve	See Load Ratings (Page 7)
7	Violet	Output	Main Fuel Valve	See Load Ratings (Page 7)
16	DK Blue	Input	Pilot Valve Hold	120/230 VAC, 1 mA
21	Pink	Input	Start Input	120/230 VAC, 1 mA
10	Wht/Red	Output	Modulator Common	120/230 VAC 75 VA
12	Wht/Yel	Output	Modulator Low Fire	120/230 VAC 75 VA
X	Wht/Blue	Output	Modulator High Fire	120/230 VAC 75 VA
11	Wht/Grn	Output	Modulator Auto	120/230 VAC 75 VA
22	Wht/Vio	Input	Remote Reset	120/230 VAC, 1 mA
23	Brn/Wht	Input	Spare 2	120/230 VAC, 1 mA

*UL does not apply to 230 VAC operations*



## INSTALLATION PROCEDURE

### WIRING BASE

Install the wiring base where the relative humidity never reaches the saturation point. The BurnerLogix system is designed to operate in a maximum 90% relative humidity continuous, non-condensing environment. Do not install the BurnerLogix system where it can be subjected to vibration in excess of 0.5G continuous maximum vibration. The BurnerLogix system does not use a weather tight enclosure. The standard vertical position is recommended. Allow at least one inch clearance around the control for service and installation.

1. Wiring must comply with all applicable codes, ordinances and regulations.
2. **Wiring must comply with NEC Class 1 (Line Voltage) wiring. (EU or Local Codes)**
3. Torque rating on terminal block screws is 4.4 in/lbs to 5.3 in/lbs.
4. Limits and interlocks must be rated to simultaneously carry and break current to the ignition transformer, pilot valve and main fuel valve(s).
5. Recommended wire routing of lead wires:
  - a. Do not run high voltage ignition transformer wires in the same conduit with any other wires.
  - b. Do not route flame detector lead wires in conduit with line or high voltage circuits. Use separate conduit where necessary.
6. Maximum wire lengths:
  - a. The maximum lead wire length is 200 ft. (61 meters) to terminal inputs (Operating limits, interlocks, valves, etc.).
  - b. Flame Detector lead wires: see section on flame scanners
  - c. Remote reset: The maximum length of wire is 500 feet (152 meters) to a normally open remote reset push-button, which must remain within sight and sound of the burner.
  - d. Modbus communications: The maximum cable length of wire is 3300 feet (1000 meters) for RS-485.

A good ground system must be provided to minimize the effects of AC quality problems. A properly designed ground system meeting all the safety requirements ensures that any AC voltage quality problems, such as spikes, surges and impulses have a low impedance path to ground. A low impedance path to ground ensures that large currents with any surge voltages follow the desired path to earth ground.

### BEFORE INSTALLING THE BURNERLOGIX CONTROL



**WARNING: Controls require safety limits using isolated mechanical contacts. Electronic limit switches can cause erratic operation and must be avoided.**



**CAUTION: Ensure that electric power is turned off. Refer to SN-100 for recommended grounding techniques.**

**Power to some interlocks (operating controls, air flow switches, modulating circuits, etc.) can be derived from sources other than what is controlling the BurnerLogix.**



## INSTALLING THE YP PROGRAMMER MODULE

FIGURE 3.

### YP110 PROGRAMMER

The YP programmer module plugs into the side of the YB110 (YB230) chassis module. They can only be installed in one direction. **DO NOT ATTEMPT TO FORCE THE YP PROGRAMMER INTO THE CHASSIS.** Referring to the illustration on the right, align the holes in the YP programmer housing with the posts located within the YB chassis. Push the YP module into the chassis until the YP module is flush with the YB housing.

If it is necessary to remove the YP programmer module from the YB chassis, 2 slots are provided on the top and bottom of the YP housing. A small screwdriver can be used to ‘pop’ the programmer from the chassis.



#### **NOTICE: For installations requiring CE certification:**

After installation, the equipment should be protected from general access by means of a cabinet which is only accessible with a key or special tool and therefore a clear responsibility who replaced the fuse. If the fuse is blown during installation or operation, the control must be sent to the manufacturer to check.

#### **ELECTRICAL CHECKOUT**

If either a ground or a short circuit is detected, it must be eliminated before the control is plugged into the wiring base and power turned on.

Test the electrical field wiring for short circuits and grounds. The recommended method requires the use of an ohmmeter set on its lowest resistance scale.

7. Touch the meter probes together and calibrate accurately to ensure a reliable test.
8. Disconnect the neutral wire (L2) from the control system at the power source. Clip one meter test lead to the grounded green wire or to terminal E and with the other probe touch each other terminal. At no time should the meters show continuity or read 0 ohms.
9. Reconnect the neutral wire (L2) at the power source. Remove the test probe from the grounded terminal and reconnect it to Terminal L2 in the wiring base. With the other probe, touch each other terminal. It is normal to obtain a resistance reading on the meter at some terminals during this test as there are resistive loads (coils, transformers, lamps, etc.) connected whose normal DC resistance may be less than 5 ohms. The test meter should not read zero ohms.

#### **NOTICE: Restore power for the following test.**

10. With your BurnerLogix installed, measure the voltage from L2 to all other terminals. The reading must be zero on all terminals except L1.

#### **INSTALL BURNERLOGIX INTO WIRING BASE**

The BurnerLogix YB chassis/amplifier module contains 2 screws permanently retained into the top and bottom of the housing. The wiring base contains two brass inserts with recessed threads to ease the installation. Line up the printed circuit board spacer located in the YB chassis/amplifier module with the alignment tabs located in the wiring base. Firmly push the YB model into the wiring base to assure the connectors mate properly. Tighten the screws into the brass inserts until snug.

## BURNERLOGIX PROGRAMMER SELECTION

All programmers for the BurnerLogiX Series are designated with the prefix “YP”. The functional operation, flame failure response time, purge timings, firing rate motor circuit, trial for ignition timings, recycling function and display messages are determined by the programmer.

Table 12 contains the most common programmers.

Check the programming sequence table for each programming module for the proper explanation of prepurge timings.



**WARNING: THE INAPPROPRIATE SELECTION OR APPLICATION OF A PROGRAMMER MODULE CAN RESULT IN AN UNSAFE CONDITION HAZARDOUS TO LIFE AND PROPERTY.** The various programmer modules are interchangeable because they plug into a common YB chassis. Many parameters are configurable through the keypad display. Care must be taken to insure the proper parameters are set. Refer to the appropriate programmer bulletin for appropriate settings. Selection of the programmer module and setting the various parameters for a particular application must be made by a competent professional, such as a Boiler/Burner technician licensed by a state or government agency, engineering personnel of the burner, boiler or furnace manufacturer (OEM) or in the performance of duties based on the information from the OEM.

**CAUTION: FOR IR MODELS, PRIOR TO VERSION 12, IT IS HIGHLY RECOMMENDED THAT AN "IR LEARN" OPERATION BE PERFORMED TO GUARANTEE RELIABLE OPERATION. REFER TO IR LEARN SECTION FOR MORE INFORMATION.**

**Table 12: BURNERLOGIX PROGRAMMER SELECTION**

FIREYE PART NUMBER	Pre-purge Programming (Seconds)	Proven High Fire Interlock (M-8)	Proven Low Fire Interlock (M-D)	Terminal 6, Interrupted or Intermittent	Early Spark Termination
<b>SETTINGS SHOWN ARE FACTORY DEFAULT</b>					
YP100	30	YES	YES	INTRP	NO
YP102	30	YES	YES	INTRP	NO
YP138	30	YES	YES	INTRP	NO
YP118	30	YES	YES	INTRP	NO
YP183	30	YES	YES	INTRP	NO
YP112	30	YES	YES	INTRP	NO
YP113	30	YES	YES	INTRP	NO
YP115	30	YES	YES	INTRP	NO
YP200	30	NO	YES	INTRP	NO
YP202	30	NO	YES	INTRP	NO
YP300	30	NO	YES	INTMT	YES
YP302	30	NO	YES	INTMT	YES





**Table 12 Continued**

FIREYE PART NUMBER	PTFI (5/6)	PTFI (W/6)	PILOT PROVING 6 Only	MTFI (5/6)	MTFI (W/6)	Running Interlock (3-P)	<sup>1</sup> Flame Fail Time (Seconds)	Firing Rate Motor
<b>SETTINGS SHOWN ARE FACTORY DEFAULT</b>								
YP100	10/10		-	10/15		Non-recycle	4	YES
YP102	10/10		-	10/15		Non-recycle	2	YES
YP138 <sup>3</sup>	10/10		-	10/15		Non-recycle	4	YES
YP118 <sup>3</sup>	10/10		-	10/15		Non-recycle	1	YES
YP183 <sup>3</sup>	10/10		-	10/15		Non-recycle	4	YES
YP112 <sup>2</sup>	-	5/5	10	-	0/5	Non-recycle	2	YES
YP113 <sup>2</sup>	-	5/5	10	-	0/5	Non-recycle	1	YES
YP115 <sup>2</sup>	-	5/5	10	-	0/5	Non-recycle	1	YES
YP200	10/10		-	10/15		Recycle	4	YES
YP202	10/10		-	10/15		Recycle	2	YES
YP300	10/10		-	10/intmt		Recycle	4	NO
YP302	10/10		-	10/intmt		Recycle	2	NO

<sup>1</sup>FFRT with YB110DC or YB230DC is 0.2 seconds.

<sup>2</sup>Terminal W is igniter, terminal 6 is pilot valve. (**Terminal 5 is not intended for use**)  
Note additional 10 second proving time during PTFI.

<sup>3</sup> Revert to pilot models.

#### **PTFI\*MTFI TIMINGS**

The BurnerLogix system provides keypad selectable timings for both PTFI and MTFI. The selections offered can provide 5 or 10 second timing for terminal 5 and 6 or a shortened time for terminal 5, allowing for early spark termination. BurnerLogix also provides selectable interrupted or intermittent operation for terminal 6.



The selections provided for PTFI\*MTFI timings are:

**Table 13: PILOT AND MAIN TRIAL FOR IGNITION TIMING**

SELECTION	PTFI		MTFI		COMMENT
	Term 5	Term 6	Term 5	Term 6	
10/10*10/15	10	10	10	15	
5/5*0/10	5	5	0	10	NO SPARK DURING MTFI
5/5*0/5	5	5	0	5	NO SPARK DURING MTFI
5/5*10/15	5	5	10	15	SHORTENED PTFI
5/5*10/10	5	5	10	10	SHORTENED PTFI
5/10*0/15	5	10	0	15	EARLY SPARK TERMINATION
5/10*0/10	5	10	0	10	EARLY SPARK TERMINATION
10/10*0/10	10	10	0	10	NO SPARK DURING MTFI
10/10*0/5	10	10	0	5	NO SPARK DURING MTFI
10/10*10/10	10	10	10	10	

**LED INDICATOR LIGHTS**

The BurnerLogix YB control module has seven (7) LED indicator lights. These annunciate the operating status of the control, and provide the reason for the last lockout condition. The “Open Damper” and “Close Damper” LED’s provide easy set-up of the modulating motor end switches. Each LED has a graphic symbol to describe its function (see Table 14).

**Table 14: LED INDICATORS**

	<b>FAN</b>	Lights when the blower motor is energized (terminal M) and flashes when the RUN/CHECK switch is in the “CHECK” position during Purge, PTFI, MTFI and AUTO.
	<b>OPEN DAMPER</b>	Blinks when the modulator motor is being driven to the high fire position. (circuit 10-X made). Once the high purge switch closes (M-8), this LED stays lit. This LED provides the status of the high fire purge interlock circuit (M-8). This LED lights anytime the M-8 circuit closes during Pre-purge, PTFI, MTFI, Post Purge.
	<b>CLOSE DAMPER</b>	Blinks when the modulator motor is being driven to the low fire position (circuit 10-12 made). Once the low fire switch closes (M-D), this LED stays lit. This LED provides the status of the low fire start interlock circuit (M-D). This LED lights anytime the M-D circuit closes during Pre-purge, PTFI, MTFI, post purge.
	<b>AUTO</b>	Lights when the control releases to automatic modulating control (circuit 10-11 made).
	<b>IGNITION</b>	Blinks during Pilot Trial For Ignition (PTFI). Stays lit during Main Trial For Ignition (MTFI).
	<b>FLAME</b>	Lights whenever flame is detected by the flame scanner.
	<b>ALARM</b>	Alarm LED blinks during lockout. The remaining LED’s indicate the lockout condition. See “Safety Lockout Codes.”



## **REPLACEABLE FUSE**

**The following applies only to the YB110 controls operating at 120 VAC, 50/60 Hz:**

The chassis/amplifier modules are designed with a field replaceable fuse to protect Terminals 5, 6, 7 and W against short circuit loads or mis-wiring. In the event the fuse becomes OPEN, the display will indicate CHECK FUSE or the CLOSE DAMPER, AUTO and IGN LED's lights. An OPEN or blown fuse is a result of an over current condition on Terminals 5, 6, 7, or W. The over current condition causing the fuse to OPEN must be resolved before another attempt to apply power.

The fuse is located on the printed circuit board containing the relays. To replace the fuse, remove power from the system and remove the control from its wiring base. Using an appropriate tool, remove the defective fuse and discard. Install a Fireeye replacement fuse (P/N 23-197). Re-install the BurnerLogix control in accordance with the installation procedure detailed in a previous section.

The YB230 control contains a non-replaceable fuse and must be returned to the manufacturer for repair or replacement.



---

## OPERATING CONTROL FUNCTIONS

1. **Operating Controls:** Pressure or temperature activated, the operating control closes, causing the burner start-up sequence to begin. When the operating control opens, the burner shuts off. The operating control is connected in the L1-3 circuit on the wiring base.
2. **Limit Switches:** These are pressure, water level or temperature activated
  - a. Recycle — To stop the burner when the limit switch opens and restart it when the limit switch recloses, recycle limit switches connected between Terminals L1 and 3.
  - b. Non-Recycle —when it is necessary to stop the burner when the limit switch opens and prevent it from starting until both the limit switch recloses and the manual reset is activated, they are connected between terminals 3 and P.
3. **Fuel Valve End Switch Interlock:** This is an integral switch mounted on the main fuel valve and activated by the valve stem. It is connected between Terminal L1 & 13. The fuel valve end switch interlock prevents a burner start-up if the valve stem is not in the “valve closed” position. This interlock must remain closed while in STANDBY and until the start of PTFI.
4. **Purge Interlock:** A firing rate motor linkage position switch or a differential air-pressure switch, that proves a maximum purge air flow rate. It is connected between Terminals M and 8. The purge interlock proves that the air damper is fully open and purge air flow rate is at maximum during the purge.
5. **Running Interlocks:** These are air flow switches, high and low fuel pressure switches, oil temperature switches, atomizing media pressure switches, and excess smoke density controls. These interlocks prove proper conditions for normal operation of the burner. They are wired in series and connected between Terminals 3 and P.
6. **Low Fire Start Interlock:** A firing rate motor linkage position switch or a damper position switch, proves both the linkage and dampers are in their proper positions to begin burner light off. This switch is connected between Terminals M and D.

---

## SETTING PROGRAMMER PARAMETERS

To change the factory default parameters stored in the programmer module an optional keypad/display (BLV512 or BLL510) is required. All configurable parameters are stored within the PROGRAM SETUP sub-menu. The keypad/display module provides tactile feedback keys that are used to access the sub-menus inherent in the BurnerLogix system.

NOTICE: All programmed settings become permanent after 8 hours of main burner (Terminal 7) on time.

The BurnerLogix display has 2 lines with 16 characters per line. The default display top line shows the current operating status. This includes the current point in the burner sequence followed by the parameter pertaining to that point in the sequence, such as time or the flame signal level. The bottom line displays the current operating status. The BurnerLogix display also provides the historical information stored in the control’s memory such as burner hours, cycles, lockouts and system hours. The remainder of the display items are menus with sub-menus indicated by a right facing arrow >. The sub-menus indicate the current value of the selected item and in some cases can be modified to suit the application.

**STANDBY  
PROGRAM SETUP >**

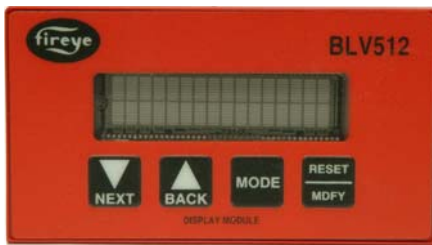
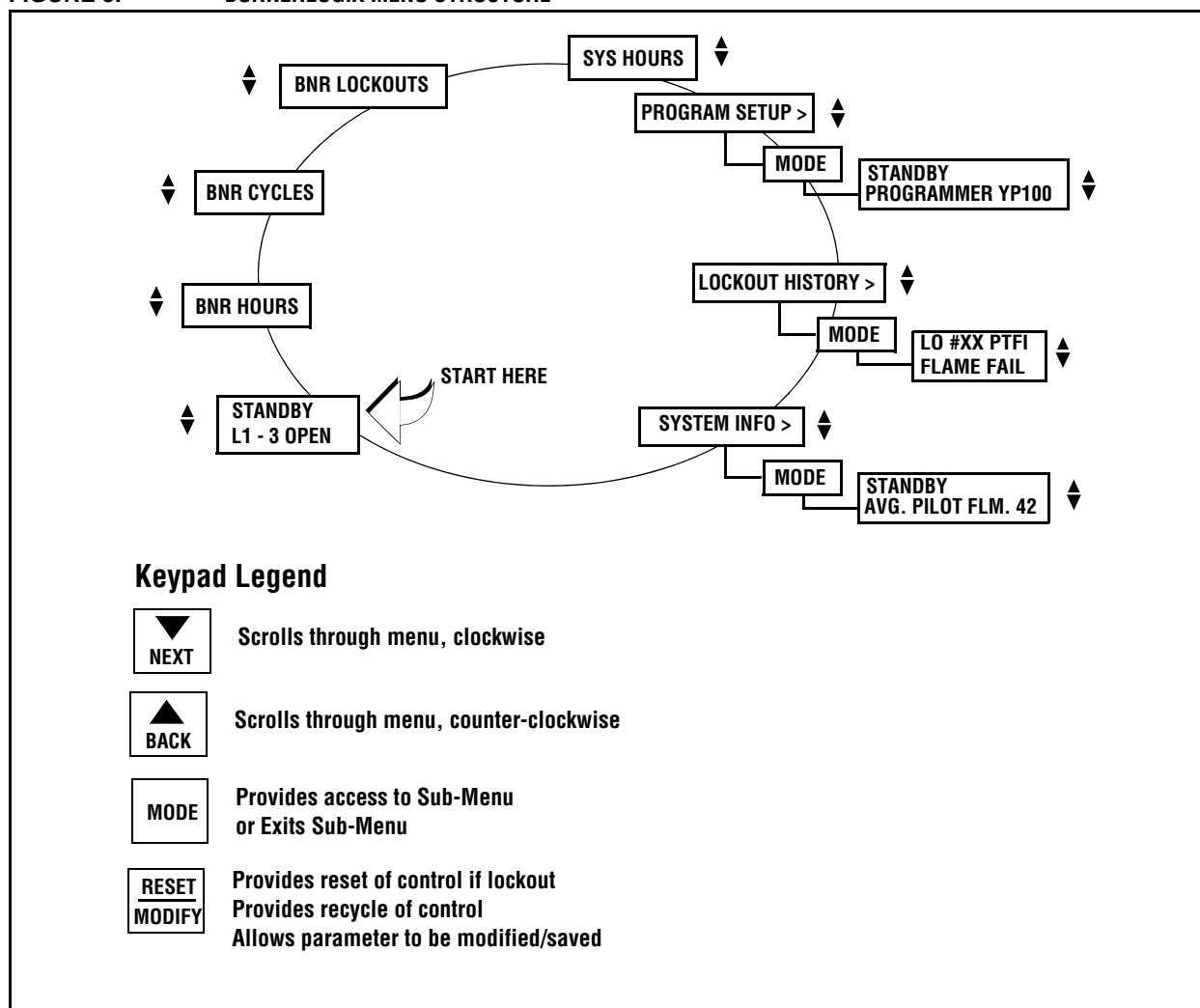

**FIGURE 4. KEYPAD DESCRIPTION**

The NEXT key is used to scroll down through the various menus. It is used to increment in the modify mode. The BACK key is used to scroll up through the menus. It is also used to decrement the value when in the modify mode. Use the MODE key to enter a sub-menu when the displayed item indicates a sub-menu with a right facing arrow >, and exit the sub-menu and move on to the next main menu item. Use the RESET/MDFY key to reset the BurnerLogix from a lockout condition, force a recycle of the programmer, indicate to the system the value displayed is to be modified or when done with the modification.

Use the RESET/MDFY key to reset the BurnerLogix from a lockout condition, force a recycle of the programmer, indicate to the system the value displayed is to be modified or when done with the modification.

**FIGURE 5. BURNERLOGIX MENU STRUCTURE**



## PROGRAM SET UP SUB-MENU

The sub-menu "PROGRAM SETUP" allows the user to review the various operational settings of the programmer module (e.g. programmer type, purge timing, etc.) and in some instances modify the operational parameters to suit the application requirement. Use the MODE key to enter and exit the sub-menu. Use the NEXT and BACK keys to scroll through the menu and change the operational parameter.

FIGURE 6. MAIN MENU

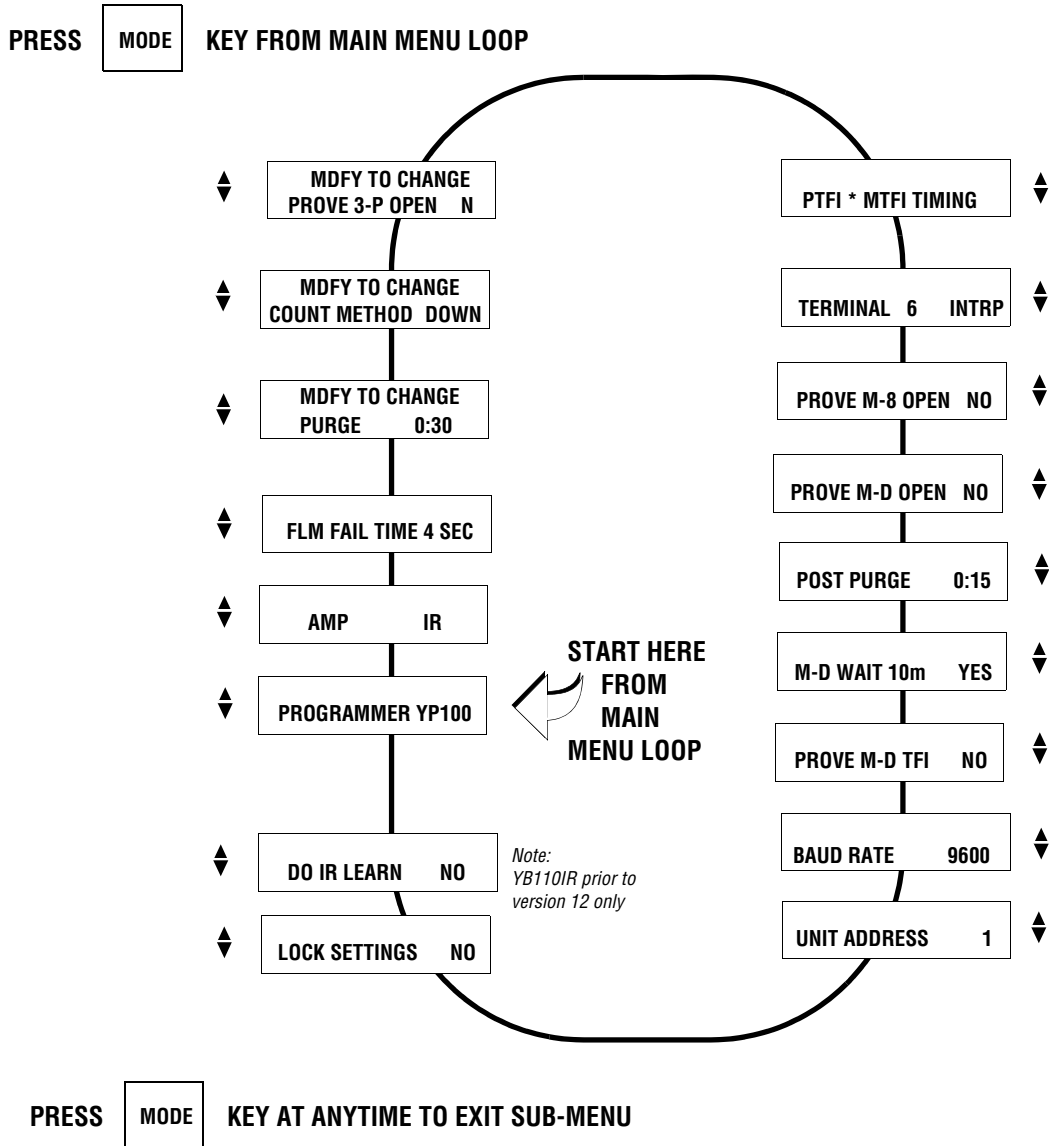

**Table 15: MODIFIABLE PARAMETERS LOCATED IN PROGRAM SETUP MENU**

Parameter	Factory Default	Range	Description
Purge time	00:30s	0:00s – 60:00m, 1 second increments. 0:00s-60:00m, YP113 0:00s-60:00m, YP115 (0:00s - 60:00m in YP3XX)	Applies to open damper purge time in YP1XX and YP2XX programmers and low fire start time in YP3XX programmers  Note: 0 sec purge requires a display with Engr code 9 or higher and chassis Engr code of 11 or higher
Count method	DOWN	UP, DOWN	Time counts UP to final value or DOWN to zero from starting value. This setting will apply to all timer values.
Prove 3-P open at start	NO	YES, NO	Prevents jumped terminals. Requires the 3-P circuit to be open at the start of a cycle.
PTFI*MTFI timing	10/10*10/15 YP113 = 5/5*3/5	See chart on page 18	Applies to terminals 5 and 6 operation during PTFI and MTFI.
Terminal 6 interrupted or intermittent	INTRP	INTRP, INTMT	Provide interrupted or intermittent operation on terminal 6.
Prove M-8 open	NO	YES, NO	If YES, M-8 must be open at start of open damper purge period. (YP1XX Series only).
Prove M-D open	NO	YES, NO	If YES, M-D must be open at end of open damper purge period. Does not apply to YP3XX Series.
Post purge	0:15	0:00s - 4:00m, 1 second increments.	Selects Post Purge time
3-P Recycle	YES	YES, NO	Applies to YP3XX series only. Allows non-recycle operation of 3-P circuit.
M-D WAIT 10m	YES	YES, NO	Select YES for lockout on M-D open for 10 minutes. Select NO for indefinite wait for M-D to close. This wait time applies prior to pilot trial for ignition.
PROVE M-D TFI	NO	YES, NO	Select YES to force lockout on M-D opening during PTFI and MTFI
Baud rate	9600	4800, 9600, 19200, 38400	Sets communication baud rate
Unit address	00	00-31	Multi-drop requires unique addressing. Lowest address allowed for modbus is 01
Lock Settings	NO	YES, NO	Parameters can be stored to memory before automatic 8 hour store.
DO IR LEARN	NO	YES, NO	Select YES to activate IR LEARN process. See IR operation. <i>IR LEARN feature does not exist for display version 10 or newer</i>

*LEGEND: Shaded parameters not affected by 8 hour burn-in or LOCK SETTINGS.*

**TO VIEW AND MODIFY A PROGRAMMABLE PARAMETER:**

Use the NEXT or BACK key to scroll to PROGRAM SETUP. Press the MODE key to enter the sub-menu showing all program setup parameters. Pressing the MODE key while in the sub-menu exits the sub-menu, and the next main menu item is displayed. While in the sub-menu, pressing the NEXT key scrolls forward through the sub-menu. Pressing the BACK key scrolls backward through the sub-menu. When a modifiable parameter is displayed, the top line indicates MDFY TO CHANGE while the bottom line indicates the current item and its current value. Pressing the RESET/MDFY key allows you to display the parameter you want to modify. The item modified moves to the top line while its value remains on the bottom line. Infrequently, the top line indicates MDFY TO SAVE. Use the NEXT or BACK keys to select the value to suit the application. When done, press the RESET/MDFY to save the changed value to memory.



**NOTICE: All programmed settings become permanent if the BurnerLogix system has been powered continuously and 8 hours of main burner (terminal 7) on time has been accumulated. If the AC power is removed prior to accumulating 8 hours of main burner on time, the system burn-in time clock is reset to zero. It is not necessary for the main burner on time to be continuous. The BurnerLogix accumulates burner on time in seconds. If necessary, the programmed settings can be made to become permanent anytime before the required 8 hours of main burner on time through the use of the optional keypad and the LOCK SETTINGS option under the PROGRAM SETUP sub menu.**

Refer to SYSTEM INFO Sub Menu, page 35, for language selection.

## FLAME SCANNERS

FIGURE 7. FLAME SCANNERS

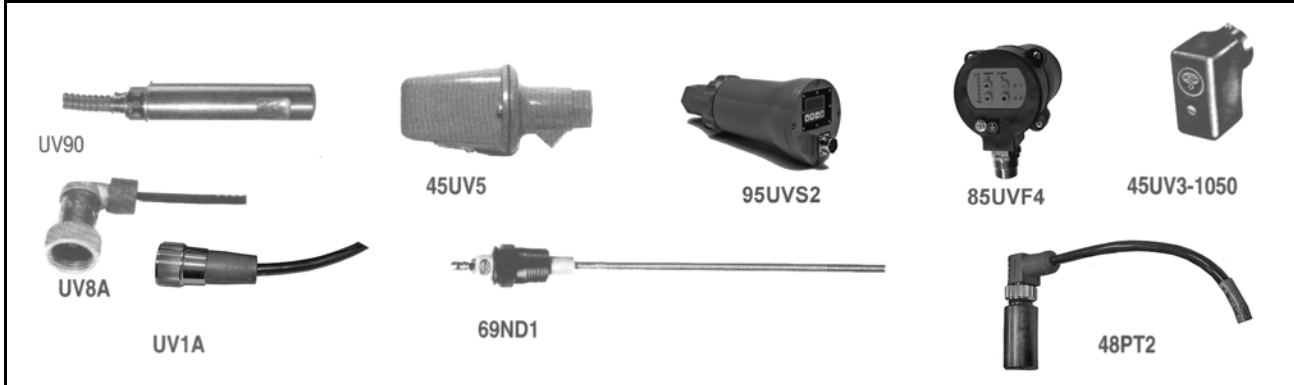

**CAUTION:** The UV1A, UV2, UV8A, UV90 and 45UV3 flame scanners and associated amplifier module are non-self checking UV systems and must only be applied to burners that often cycle (e.g.: a minimum of once per 12 hours) in order for the safety checking circuit to be exercised. If component checking is required during burner operation for constantly fired burners, use the self-checking ultra-violet flame scanners (45UV5, 55UV5) with the associated amplifier modules (YB110UVSC), the infrared flame scanner (48PT2) with associated Auto Check amplifier (YB110IR), or integrated scanners (Phoenix, InSight II or InSight with associated amplifier (YB110DC).

### INSTALLATION - UV SCANNERS

Where possible, obtain the burner manufacturer's instructions for mounting the scanner. This information is available for most standard burners. The scanner mounting must comply with the following general instructions:

1. Position the UV1A, UV2 scanner within 30 inches of the flame to be monitored; the 45UV5 within 72 inches, closer if possible.
2. Select a scanner location that remains within the ambient temperature limits of the UV Scanner. If cooling is required, use an insulating coupling (Fireeye #35-69 for UV1A, UV2 Scanners, #35-127-1 for 45UV5) to reduce conducted heat.
3. The UV1A, UV2, 45UV5 Scanners are designed to seal off the sight pipe up to 1 PSI pressure. Higher furnace pressures should be sealed off. To seal off positive furnace pressure up to 100 PSI for UV1A, UV2 Scanners, install a quartz window coupling (#60-1257) For 45UV5 Scanners, use #60-1100 coupling. Add cooling air to reduce the scanner sight pipe temperature.
4. Install the scanner on a standard NPT pipe (UV1A: 1/2", UV2: 3/8", 45UV5: 1") whose position is rigidly fixed. If the scanner mounting pipe sights through the refractory, do not extend it more than halfway through. Swivel flanges are available if desired (#60-302 for UV1A, UV2 Scanners, #60-1664-3 for 45UV5). The sight pipe must permit an unobstructed view of the pilot and/or main flame, and both pilot and main flames must completely cover the scanner field of view.

FIGURE 8. AIMING YOUR SCANNER.

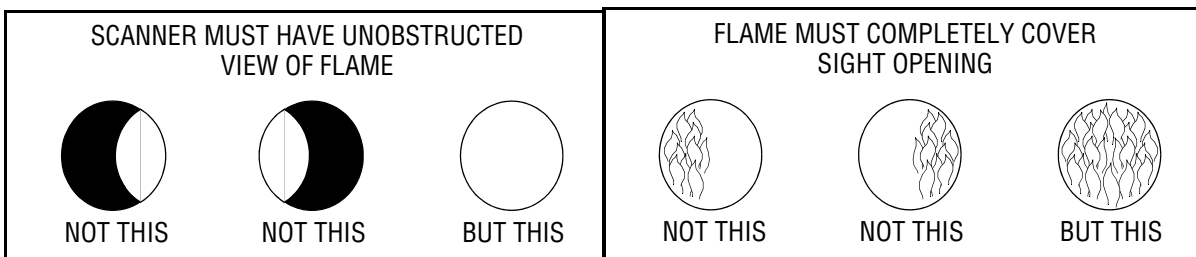



5. Smoke or unburned combustion gases absorb ultra-violet energy. On installations with negative pressure combustion chambers, a small hole drilled in the UV1A, UV2 sight pipe will assist in keeping the pipe clean and free from smoke. Provide clean air to pressurize the sight pipe, if necessary for positive pressure furnaces.
6. Two UV1A or UV2 Scanners may be installed on the same burner if it is necessary to view two areas to obtain reliable detection of the flame. They are wired in parallel. Only one repetitive selfchecking 45UV5 Scanner can be installed on a burner.
7. To increase scanner sensitivity with UV1A, UV2 Scanners, a quartz lens permits location of the scanner at twice the normal distance. Use 1/2" x 1 1/2" pipe nipple between UV1A Scanner and the coupling. Use 3/8" pipe nipple and a 1/2" x 3/8" bushing on UV2 installations.
8. Request the assistance of any Fireye field office for recommendations of a proper scanner installation on a non-standard application.

**FIGURE 9. TYPICAL SCANNER INSTALLATIONS**

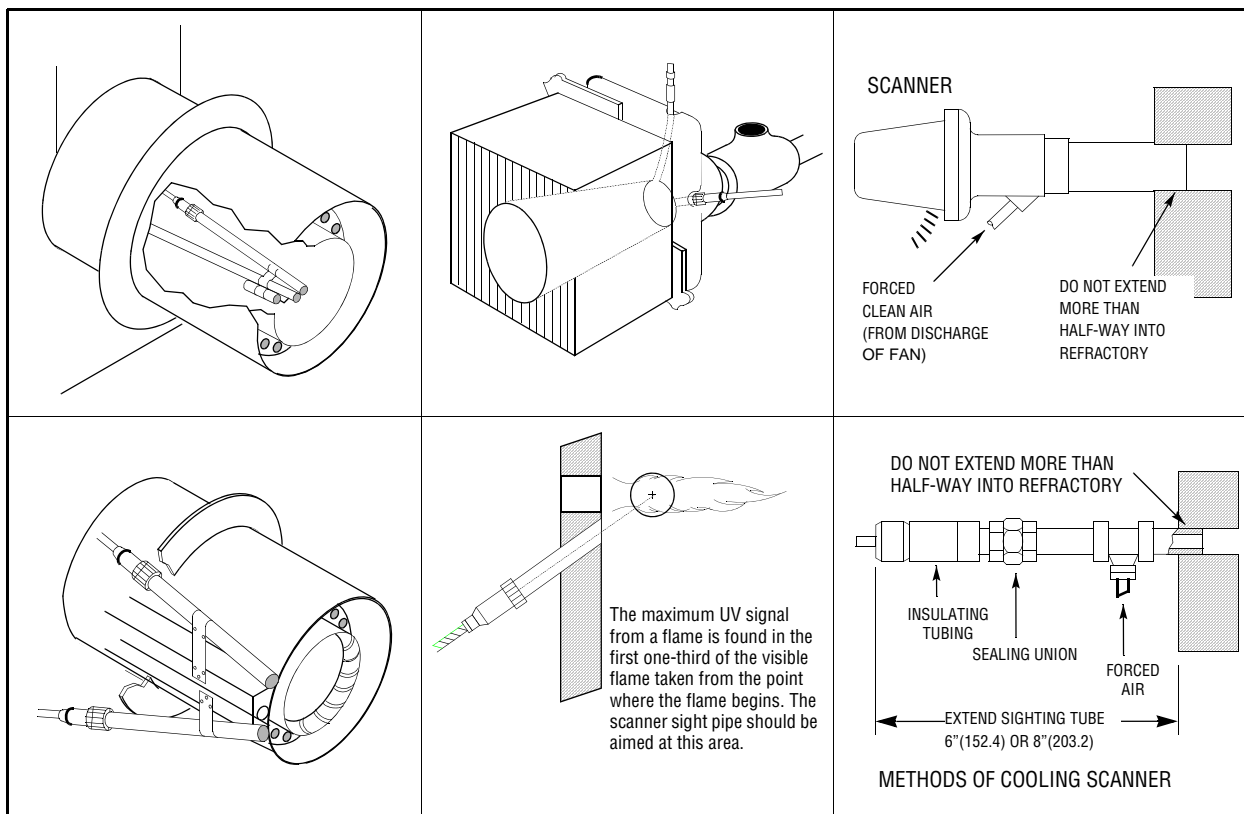

**OPERATION — 45UV5 & 55UV5 SELF-CHECKING UV SCANNER**

Self-checking ultra-violet scanners are used in applications where burner firing operation is continuous or where the burner is on for long periods of time without recycling and UV detection is the best alternative. In addition, ultra-violet self-checking systems are mandatory in some locations.

The operation of this type of system consists of maintaining the flame scanning capability at all times while also proving that the ultra-violet tube is firing properly. Do this periodically by mechanically closing off the sight of the UV tube. Check to make sure that the flame signal goes away.

A shutter assembly in the 45UV5 scanner performs this function. The diagram below explains the process further.

If the shutter assembly in the scanner fails, the tube is faulty, or there is insufficient power to the scanner, the BurnerLogix will LOCKOUT and display the following message LOCKOUT CHECK SCANNER. The ultra-violet tube is replaceable (P/N 4-314-1).

A lockout results if a minimum signal is detected for three consecutive shutter closed periods.

**FIGURE 10. UV SELF CHECK SCANNER OPERATION**

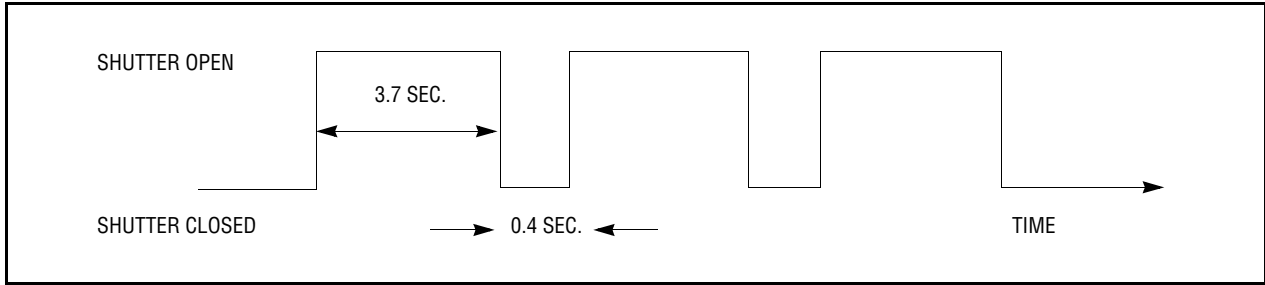

### WIRING - UV SCANNERS

To connect the scanner to the control, the UV1A Scanner is supplied with either 36"(.9m) or 72" (1.8m) of flexible cable. The 45UV5 is supplied with four 72" (1.8m) lead wires. Install them in a suitable length of flexible armor cable and connect it to the control. A conduit connector is supplied with the scanner. Connect black wires (shutter) to terminals L1, L2; red wires (UV tube) to terminals S1, S2.

If it is necessary to extend the scanner wiring, the following instructions apply:

Scanner wires should be installed in a separate conduit. The wires from several scanners may be installed in a common conduit.

#### 1. Selection of Wire

a. Wiring: For extended scanner wiring up to 500 feet, and for shorter lengths to reduce signal loss, use a shielded wire (Belden 8254-RG62 coaxial cable, or equal) for each scanner wire of UV1A, UV2 and each red wire of the 45UV5. The ends of the shielding must be taped and not grounded.

b. Asbestos insulated wire must be avoided.

c. Multiconductor cable is not recommended without prior factory approval.

#### 2. High voltage ignition wiring must not be installed in the same conduit with flame detector wires.

### INSTALLATION—INFRARED SCANNER TYPE 48PT2

Where possible, obtain the burner manufacturer's instructions for mounting the scanner, otherwise proceed as follows:

A single scanner is used to detect both pilot and main flames. The sight pipe on which the scanner mounts must be aimed so that the scanner sights a point at the intersection of main and pilot flames.

Proper scanner positioning must assure the following:

1. Reliable pilot flame signal.
2. Reliable main flame signal.
3. A pilot flame too short or in the wrong position to ignite the main flame reliably, must not be detected.
4. Scanner must have an unobstructed view of flame being monitored.
5. Flame being monitored must completely cover the scanner field of view.
6. To avoid nuisance shutdowns, it is important to avoid sighting hot refractory and to keep scanner temperature below 140° F (60°C).
7. When the proper position has been established, drill a hole through the furnace wall and install a 4" to 8" (101.6mm x 203.2mm) length of threaded 1/2" black iron pipe on which to mount the 48PT2 scanner.
8. When satisfactory sighting position has been confirmed by operating tests, the sight tube should be firmly welded in place.

**FIGURE 11. SCANNER INSTALLATION**

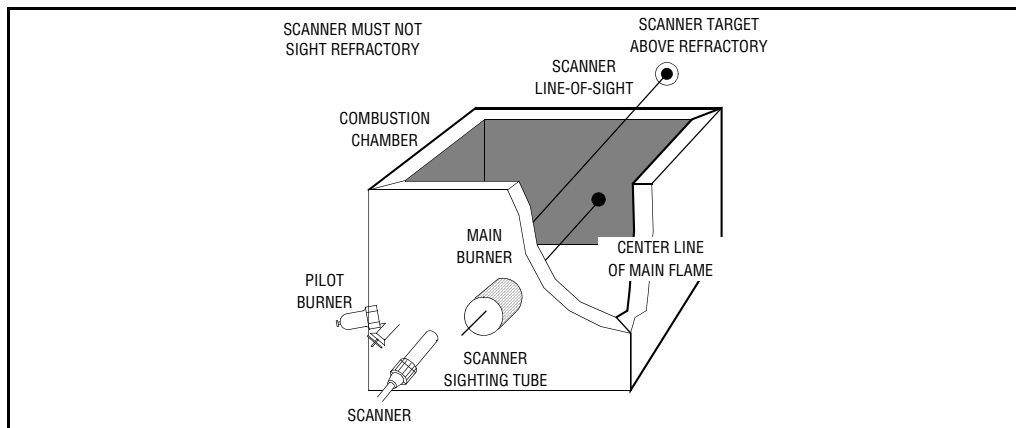

**WIRING**

Attach the cable supplied with the scanner to a junction box. Splice the cable wires to a pair of wires not smaller than #18. Install the complete run in a separate conduit to the control. Continuous conduit bonding between scanner and the control is mandatory! Scanner may be located up to 100 feet from control. Do not pass scanner wiring through any junction box containing other wires. Do not run other wires through scanner conduit. Asbestos insulated wire must be avoided.

9. To avoid nuisance shutdowns, avoid sighting hot refractory and to keep your scanner temperature low below 140° F (60°C).
10. When the proper position has been established, drill a hole through the furnace wall and install a 4" to 8" (101.6mm x 203.2mm) length of threaded 1/2" black iron pipe on which to mount the 48PT2 scanner.
11. When satisfactory sighting position has been confirmed by operating tests, the sight tube must be firmly welded in place.

**OPERATION - IR LEARN (for IR Models prior to Version 12 only)**

The BurnerLogix IR learn adapts the operation of the amplifier to the actual burner environment. 'Out of the box', the BurnerLogix IR system is shipped with its sensitivity and thresholds set to detect most firing conditions and does not require learning. The purpose of the LEARN process is to maximize reliable flame detection over a wide range of conditions. The learn process sets the optimum values for the flame on and flame off thresholds during pilot trial for ignition and the main firing period separately. The LEARN process allows the BurnerLogix system to better differentiate between real and simulated flame conditions. Simulated flame can be caused by burner throat modulation, radiation from the refractory tiles, or steam atomization. The result of this technique of flame detection assures a positive flame out response for usual or adverse conditions. Although it is not necessary to perform an IR LEARN, it is suggested this be done as part of the installation process or when the 48PT2 scanner is changed.

The type of burner and fuel will affect the amplitude and radiation characteristics of the flame. Gaseous flames tend to have low amplitude and radiation whereas oil flames have a high amplitude and radiation. On burners having the option to fire both gaseous and oil fuels, it is recommended the LEARN process be performed on the condition that has the lowest signal level. Normally this condition is gas at low fire.

The LEARN process in the BurnerLogix system is initiated through the keypad display module. The menu item is located under the PROGRAM SETUP menu and is called DO IR LEARN. Refer to the section titled '**SETTING PROGRAMMER PARAMETERS**' for information on setting operational values. Since the default value is NO, the user must modify this value to YES.

**MDFY TO CHANGE  
DO IR LEARN    YES**



**The LEARN process is not subject to the 8 hour burn-in and therefore will always be available.** If the LEARN process is activated at STANDBY, the LEARN process will involve both pilot and main flame. If the LEARN process is activated during the main firing period (AUTO) the LEARN process will only involve the main flame learn. During this LEARN process in AUTO, the thresholds for pilot flame are not affected. It is necessary to have separate learns to adjust for the characteristics of the flame changing conditions due to changes in background conditions after a long firing period.

**Once a LEARN process is activated, it cannot be undone. Also, if a LEARN cannot be completed in the subsequent burner cycle due to burner interruptions or a flame fail, the LEARN process will continue to remain active.** During PTFI, the LEARN process takes place during the last 3 seconds of the pilot period and is indicated on the display:

**PTFI                    80  
LEARNING FLAME**

During AUTO the LEARN process takes place during the first 3 seconds of AUTO and is indicated on the display

**HOLD                    80  
LEARNING FLAME**

After the LEARN process is completed the flame signal displayed value is normalized to a value of 32.

**AUTO                    32  
FLAME SIGNAL**

Therefore during the next pilot trail for ignition period the expected value of flame signal should be 32.

**PTFI                    32  
FLAME SIGNAL**

Any increases or decreases in amplitude or radiation may cause the displayed value to increase or decrease. Should the displayed value continue to decrease, possibly due to changing conditions in the boiler such as a bright background causing a reduction in scanner sensitivity, it is suggested to activate a new DO IR LEARN during AUTO. Without shutting the burner off, scroll to PROGRAM SETUP and in that sub-menu, modify DO IR LEARN to YES. The LEARN function will be activated immediately. [Note: The display will continue to indicate YES even though the LEARN process is complete. Pressing the up arrow and then down arrow will indicate the updated state of DO IR LEARN.]

An abrupt change in the background radiation (brightness) may be an indication that the firing characteristics of the fuel have changed. In oil fired units this may be caused by a sudden interruption in the oil delivery. The BurnerLogix utilizes this information to make a decision to keep the burner on line or force a shut down. A lockout will happen if the background radiation (brightness) changes downward by 20% in and stays at this level for 1 FFRT. Also, if the detected flame signal average falls below 20% of the Learned On value, the burner will also be shut down.



### Keeping the Scanner Cool

Never let your Infrared Scanner (Temperature Limit 140° F) get too hot to grasp comfortably in your hand. Keep the scanner cool by one or more of the following methods.

1. Use 6" to 8" (152.4mm x 203.2mm) length of pipe between scanner and hot furnace front plate.
2. Use an insulating tube (P/N 35-69) on the end of the iron pipe.
3. Force air into the sighting tube. Use Fireeye Sealing Union (P/N 60-801).
4. Make sure your sighting tube does not extend more than halfway into refractory wall.

### INSTALLATION - 69ND1 FLAME ROD

The 69ND1 flame rod proves a gas pilot flame and/or main gas flame. It is a spark plug type unit. It consists of 1/2" "NPT" mount, a KANTHAL flame rod, a glazed porcelain insulating rod holder and a spark plug connector for making electrical connections. The 69ND1 is available in 12", 18" or 24" (.3m, .46m, .6m) lengths.

The flame rod may be located to monitor only the gas pilot flame or both the gas pilot and main gas flames. Mount it with a 1/2" "NPT" coupling.

The following instructions should be observed:

1. Keep your flame rod as short as possible.
2. Keep your flame rod at least 1/2" from any refractory.
3. Your flame rod must enter the pilot flame from the side so as to safely prove an adequate pilot flame under all draft conditions.
4. If the flame is nonluminous (air and gas mixed before burning), extend the electrode tip at least 1/2" into the flame, but not more than halfway through.
5. If the flame is partly luminous, the electrode tip must extend only to the edge of the flame. It is not necessary to maintain uninterrupted contact with the flame.
6. It is preferable to angle the rod downward to minimize the effect of sagging and to prevent it from coming in contact with any object.
7. An adequate grounding surface for the flame must be provided. The grounding surface in actual contact with the flame must be at least 4 times greater than the area of the portion of the flame rod in contact with the flame. It is essential to adjust the flame rod and ground area ratio to provide a maximum, signal reading.

*Note: Interference from the ignition spark can alter the true signal reading by adding to, or subtracting from it. This trend sometimes may be reversed by interchanging the primary wires (line voltage) to the ignition transformer. This interference can also be reduced by the addition of grounded shielding between the flame rod and ignition spark.*

### INSTALLATION - 85 SERIES PHOENIX SCANNER

Fireye Phoenix 85UVF self-checking scanners are used to detect 295 to 340 nanometers wavelength ultraviolet emissions.

Fireye Phoenix 85IRF self checking scanners are used to detect 830 to 1100 nanometers wavelength infrared emissions.

Fireye Phoenix scanners are suited for application to duct burners, industrial gas/oil burners, refinery applications, ignition systems and Low NOx detection and for continuous or non-continuous burner operation.

NOTE: Because the sensors in the Phoenix are solid state devices they can perform well with many different fuels. For example UV is typically used on gaseous fuels but can also be applied to oils and heavy oils. To be 100% sure of correct application a test should be performed. Phoenix scanners ARE NOT recommended for use on small pilot flames or obstructed sighting.

Operator interface to the Phoenix scanner is via a pushbutton keypad and informative LEDs. These provide continuous indication of flame signal, flame relay status, scanner status as well as selected mode of operation. Simplified keystroke routines are used for setup and this can be completed in seconds. For remote interface, outputs are provided for flame switch, fault relay and 4 to 20mA flame strength.

The installer must assure the combined flame failure response (FFRT) time of the Phoenix and BurnerLogix is within the guidelines of the local codes. Refer to bulletin CU-114 for detailed information.

**FIGURE 12. PHOENIX WIRING DIAGRAM**

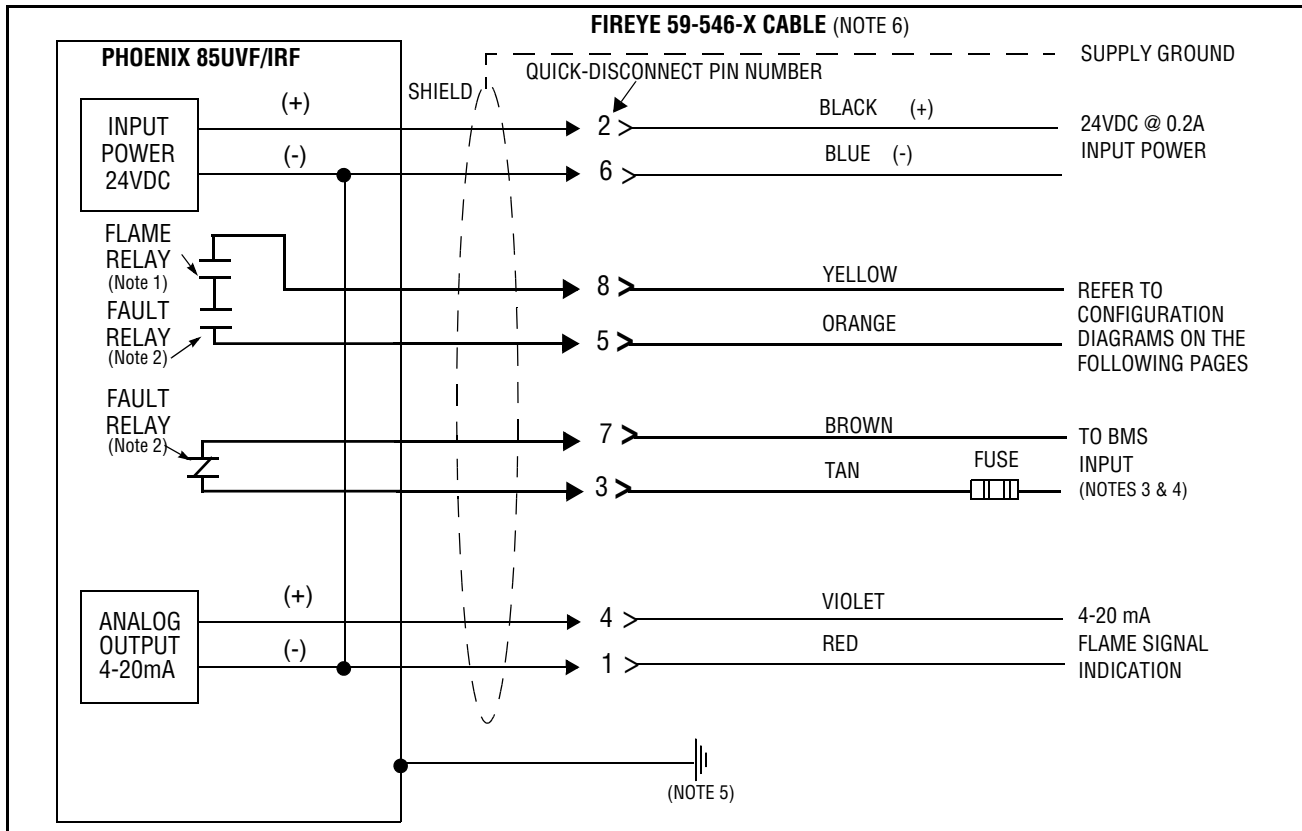

**Notes:**

1. Flame relay contacts are shown in the de-energized (no flame condition).
2. Fault relay contacts are shown in de-energized (fault) condition.





## **INSTALLATION - 95 SERIES INSIGHT SCANNERS**

Type 95IR contains an infrared flame sensor, responding to infrared radiation from 700 to 1700 nanometers wavelength. This sensor is best suited to coal and oil applications.

Type 95UV contains an ultraviolet flame sensor, responding to ultraviolet radiation from 295 to 320 nanometers wavelength. This sensor is best suited to gas applications.

Type 95DS (Dual sensor) contains both the infrared and ultraviolet flame sensors described above. This sensor is best suited to multi-fuel applications.

The InSight scanners measure the amplitude of the modulations (the flame “flicker”) that occur within the targeted flame. During the scanner set-up procedure, the modulation frequency that yields the best flame ON/OFF discrimination is selected. The appropriate modulation frequency and sensor gain is either manually selected (S1 models), or automatically selected with manual override capability (S2 models).

The InSight 95IR, 95UV, and 95DS scanners are each available in two models differentiated by feature levels.

The Standard Model S1 has three choices of modulation frequency, adjustable sensor gain, adjustable flame relay ON/OFF thresholds, 4-20 mA analog signal strength output, fault relay, and two selectable programmable files to store setpoints (for two different fuels or firing rates).

The Expanded Model S2 adds automatic programming (AutoTune) with manual override capability, 21 choices of flame flicker frequency, a total of four selectable programmable files to store setpoints, plus adds remote communication capability via Fireeye Windows 95/98/NT user software.

All FIREYE InSight scanner models are powered by 24 Vdc and contain electronic self-checking (no mechanical shutter required). The scanners contain an eight character alpha-numeric LED display and a four (4) push-button keypad to enable the user to view operating parameters and select setpoints.

The Standard Model S1 is best suited to the many applications that do not require the level of sophistication, or the remote communications capability of the Expanded Model S2 (e.g. single burner boilers and furnaces, duct burners, etc.)

The Expanded Model S2 is best suited to the applications that require the highest level of sophistication and flexibility (additional choices of modulation frequencies, and the time-saving AutoTune function), and remote communications capability (e.g. larger multi-burner boilers and furnaces).

Because of the shorted cable detect algorithm built into the BurnerLogix, it is imperative the proper cable be used when employing InSight scanners.



**FIGURE 14. INSIGHT WIRING DIAGRAM**

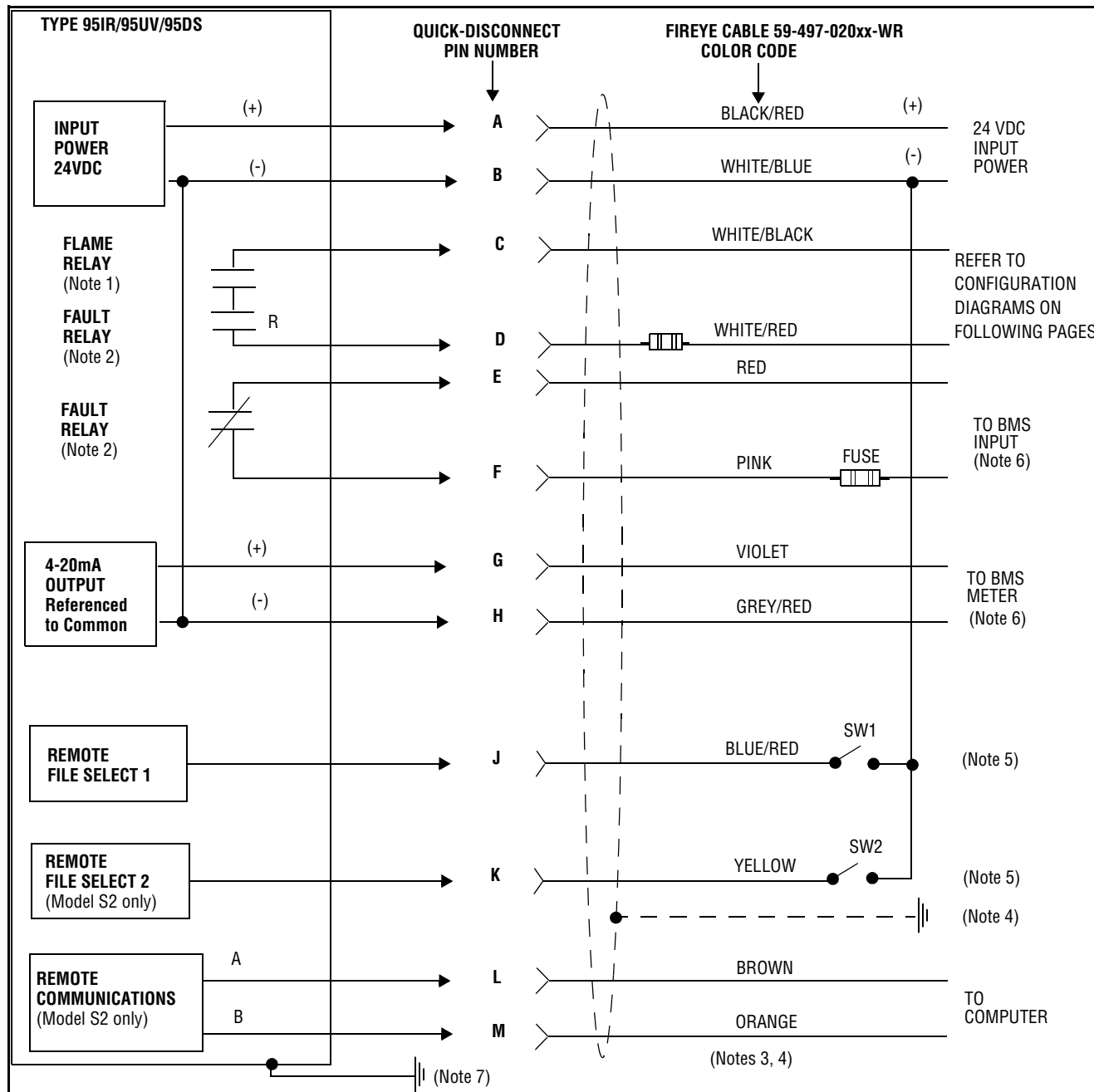

**Notes:**

1. Flame relay contacts are shown in de-energized (no flame) condition.
2. Fault relay contacts are shown in de-energized (fault) condition.
3. Brown and orange wires are a twisted pair.
4. Connect cable shield to earth ground at the power source.
5. With Remote File Select programmed as "LINE", external switches SW1/SW2 (not furnished) select between two (S1 Models) or four (S2 Models) internal memory files, when connected to 24Vdc (-) supply.
6. External 2.0 Amp fuses recommended.
7. A ground screw is provided on the scanner end plate. An external ground wire must be installed if line voltage is applied to the relay contacts.

**FIGURE 15. CONNECT BURNERLOGIX & INSIGHT I**

**BurnerLogix YB110DC/YB230DC & INSIGHT scanner with 59-497-020xx-WR CABLE**

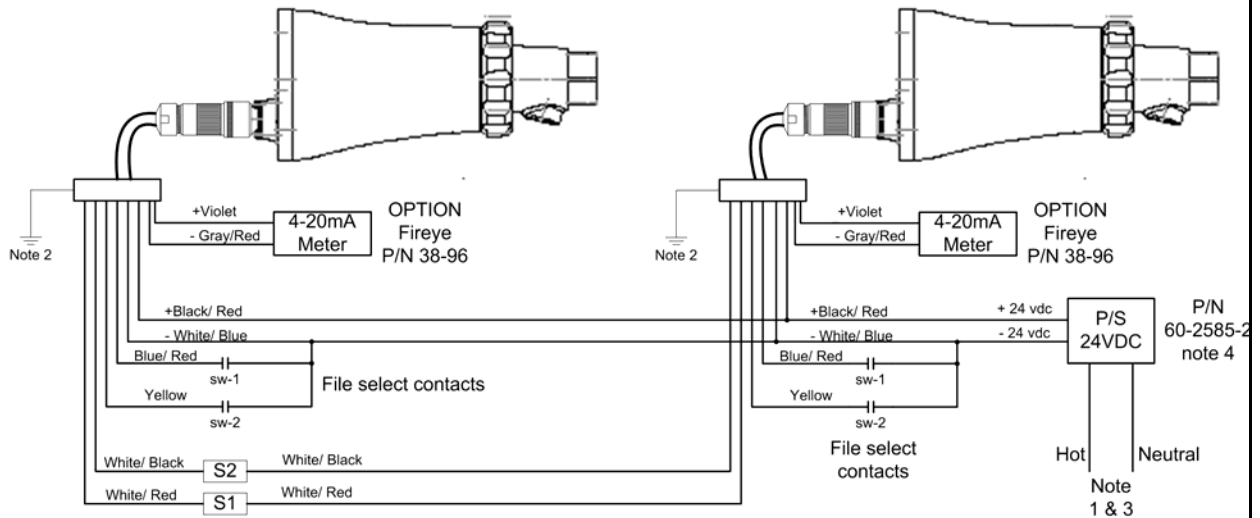

On 60-2814-1 wiring base

- Note 1: Disconnect means & overload protection required
- Note 2: Scanner shield must be connected to earth ground
- Note 3: 24 VDC supply must be powered from same main supply as YB110/YB230

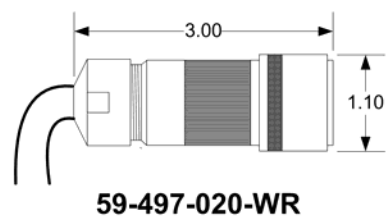
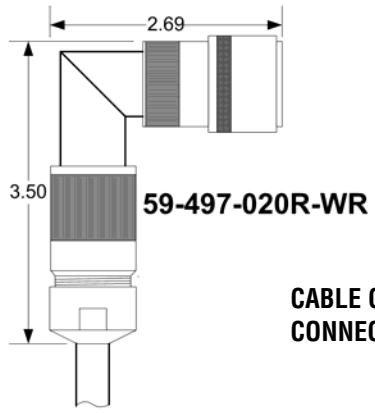
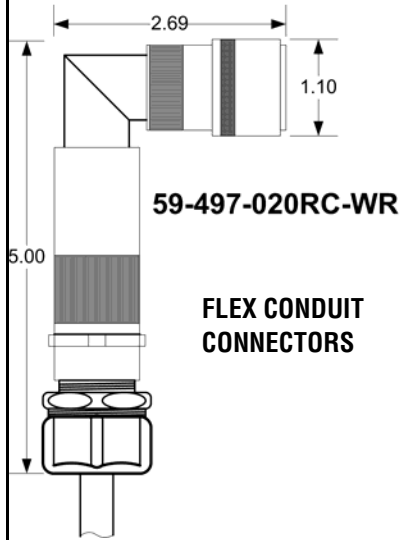
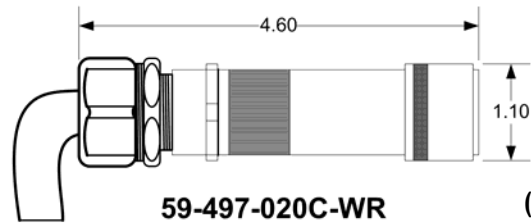

## SYSTEM INFO SUB-MENU

The sub-menu "SYSTEM INFO" allows the user to review information pertaining to the operation of the control (e.g. average main flame signal strength, status of the high fire and low fire end switches, etc.). This information can be very helpful when setting the damper linkages on the firing rate motor. The user may also clear the internal burner history (burner hours, cycles and system hours), number of lockouts and stored lockout information.

Language choices of English, French, Spanish, Dutch German and Swedish are available.

The MODE key is used to enter and exit the "SYSTEM INFO" sub-menu, and the NEXT and BACK keys are used to advance through the sub-menu.

FIGURE 16. SYSTEM INFO SUB-MENU

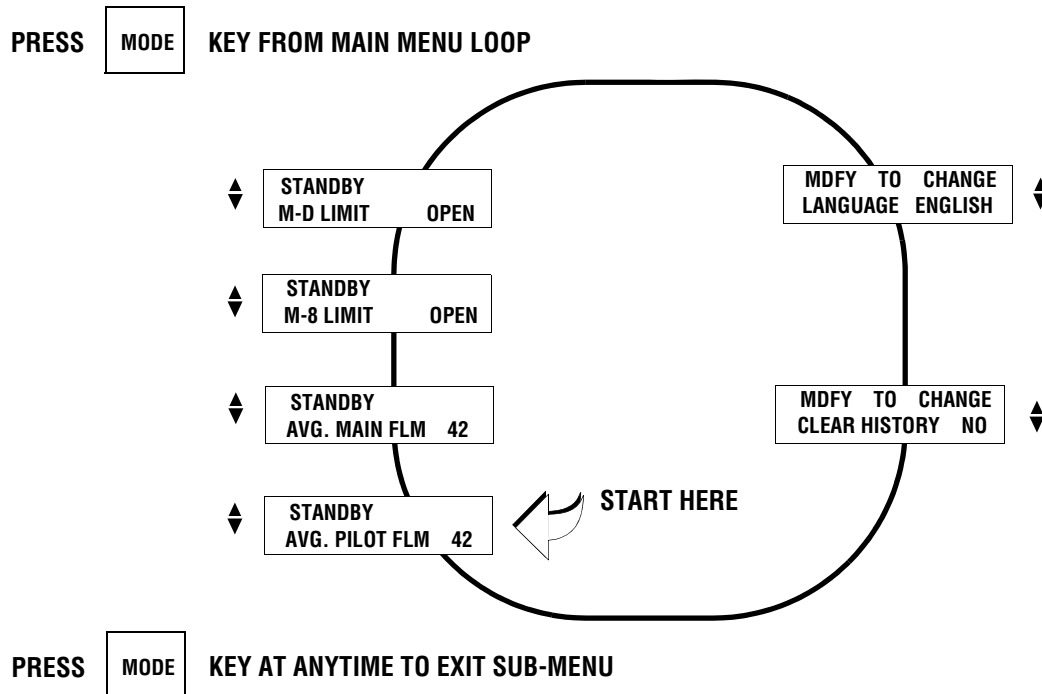

## SYSTEM OPERATION

The programmer module determines the functional operation of the Burnerlogix control (e.g. purge timing, trial for ignition timings, recycle or non-recycle operation, etc.). As illustrated, we are using the YP100 Programmer functions and messages associated with the BLL510 display module in this bulletin. **Because the messages change depending upon which YP style programmer is being used, it is necessary to check the bulletin covering the specific programmer for exact details.** Refer to the suggestions shown in this bulletin before proceeding to power the Fireye YB110 (YB230) BurnerLogix system. Items such as scanner installation, short circuit tests and safety information must be carefully reviewed.



**FIGURE 17. YP100 OPERATING SEQUENCE**

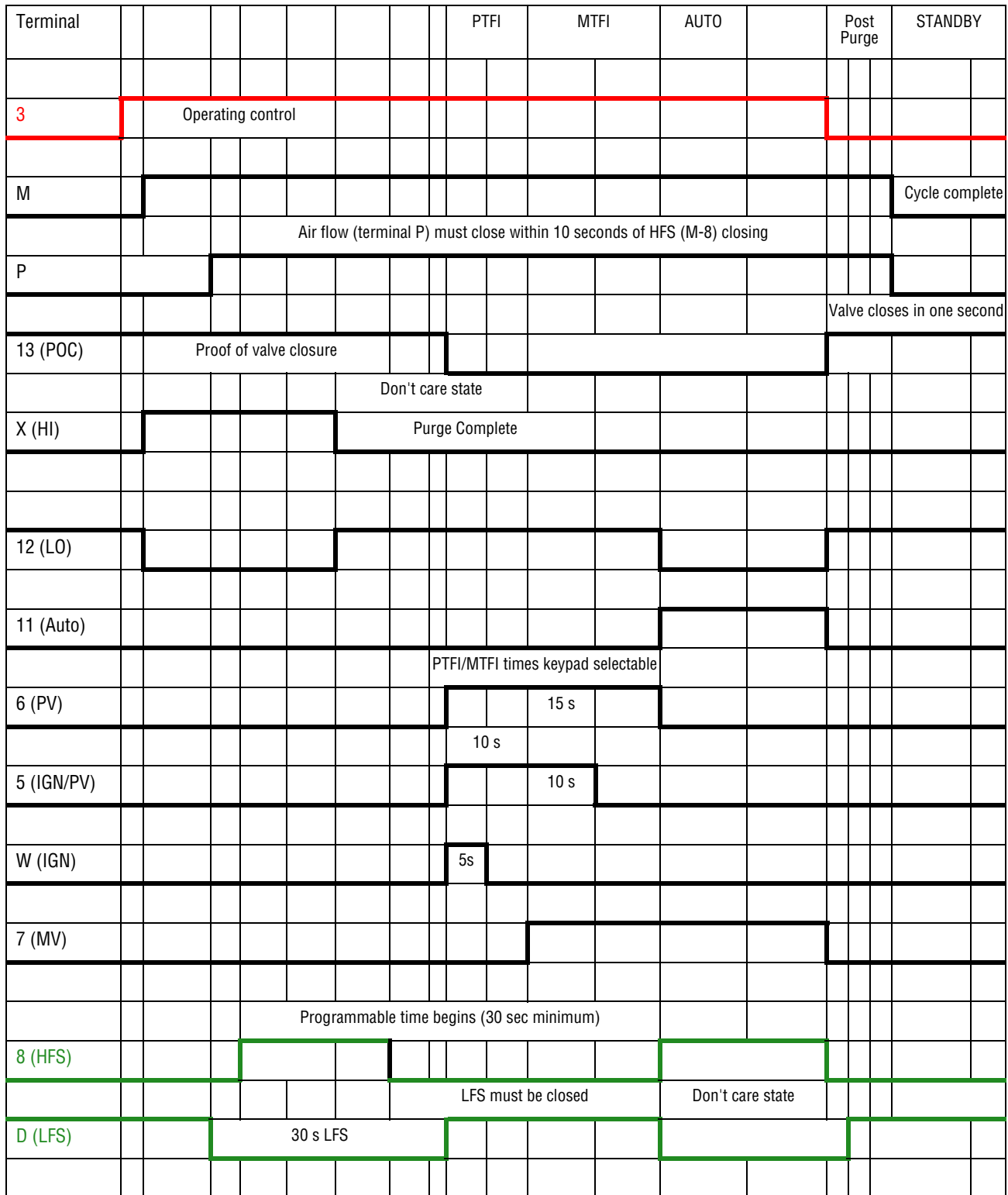



## START-UP (NORMAL CYCLE)

*Note: For direct spark ignited oil burners, substitute the words Main-Oil Valve for Pilot Valve.*

1. Constant 120 VAC must be available to the L1-L2 terminals only on the wiring base.
2. The operating control circuits (L1-3) will close, signaling the burner to start its firing sequence. Terminal 13, fuel valve end switch must be closed.
3. The burner/blower motor (terminal M) circuit is energized. The running interlock (limit) circuit (3-P) closes (e.g. all limits, interlocks, etc. are proven).
4. The firing rate motor (Modulator Motor) drives toward the high purge open damper position (10-X circuit made).
5. When the firing rate motor reaches its open damper position, the Hi Purge switch closes (M-8) and the prepurge interval of 30\* seconds starts.  
Assuming countdown method, the BLV512 displays:

**PREPRG            00:25**  
**HIGH FIRE PURGE**

If the M-8 circuit does not close, the program holds in this position for ten minutes waiting for it to close. If it does not, the control locks out. If the M-8 circuit is closed at the start of a cycle, the top line of a display switches to PURGE for 20 seconds.

**PURGE            00:19**  
**HIGH FIRE PURGE**

If the M-8 circuit is not closed at the beginning of a cycle, the top line of a display switches to PURGE for 10 seconds.

**PURGE            00:10**  
**HIGH FIRE PURGE**

6. When the prepurge is completed, the firing rate motor is driven toward the low purge damper position (10-12 circuit made). The BLV512 displays:

**PURGE            00:24**  
**LOW FIRE PURGE**

7. Following the minimum 30 second delay (10 second delay on YP113) to permit the firing rate motor to get to the low fire position, the control waits for the low fire switch (M-D) to close. When it closes, the trial for ignition sequence starts. If after ten minutes, the M-D circuit is not closed, the control locks out unless selected to wait indefinitely.
8. The trial for ignition period begins with Terminals 5, 6 and W energized simultaneously. This is PTFI (Pilot Trial for Ignition). The BLV512 displays:

**PTFI            00:02**  
**IGNITION TIMING**

This period is ten seconds in duration. Terminal W de-energizes after 5 seconds. Refer to PTFI\*MTFI TIMINGS to determine times selected or timings appropriate for the application. The test meter jacks on the YB110 (YB230) provides an indication of the flame signal strength. The flame signal readout is also available on the alpha-numeric display.

	<b>TEST JACKS</b>	<b>DISPLAY</b>
MINIMUM ACCEPTABLE	6-16	6mA
NORMAL	7.5 -20mA	20-80



**PTFI 20**  
**FLAME SIGNAL**

9. With flame proven at the end of PTFI, the main flame trial for ignition (MTFI) period begins. Terminal 7 is energized. The BLV512 displays:

**MTFI 35**  
**FLAME SIGNAL**

Terminal 5 is de-energized 10 seconds later and Terminal 6 is de-energized after another 5 seconds.

10. The firing rate motor is sent to the automatic modulation position (10-11 circuit made) and is under the command of the proportional controller. The BLV512 displays:

**AUTO 40**  
**FLAME SIGNAL**

#### **Normal Shutdown**

1. When the operating control circuit (L1-3) opens, the main fuel valve is de-energized. The firing rate motor is driven to the low purge position (10-12 circuit made).
2. Following a 15 second post purge, the burner/blower motor is de-energized.

**POST PURGE 0:05**  
**CYCLE COMPLETE**

3. The burner is now off and the BLV512 displays:

**STANDBY**  
**L1-3 OPEN**



**FIGURE 18. YP200 OPERATING SEQUENCE**

	OPEN DAMPER PURGE (begins after terminal M energized or cycle start)	PTFI	MTFI	AUTO						Post Purge
3	Operating control									
M										Cycle complete
	Air Flow (terminal P) must close within 20 seconds of cycle start									
P										
13 (POC)	Proof of valve closure									
	Programmable time begins (30 sec minimum)			Don't care state						
X (HI)										
12 (LO)										
11 (Auto)										
6 (PV)			10 s	15 s						
5 (IGN)			10 s	10 s						
7 (MV)										
	Ignore M-8 Input									
8 (HFS)										
							Don't care state			
D (LFS)			30 s							

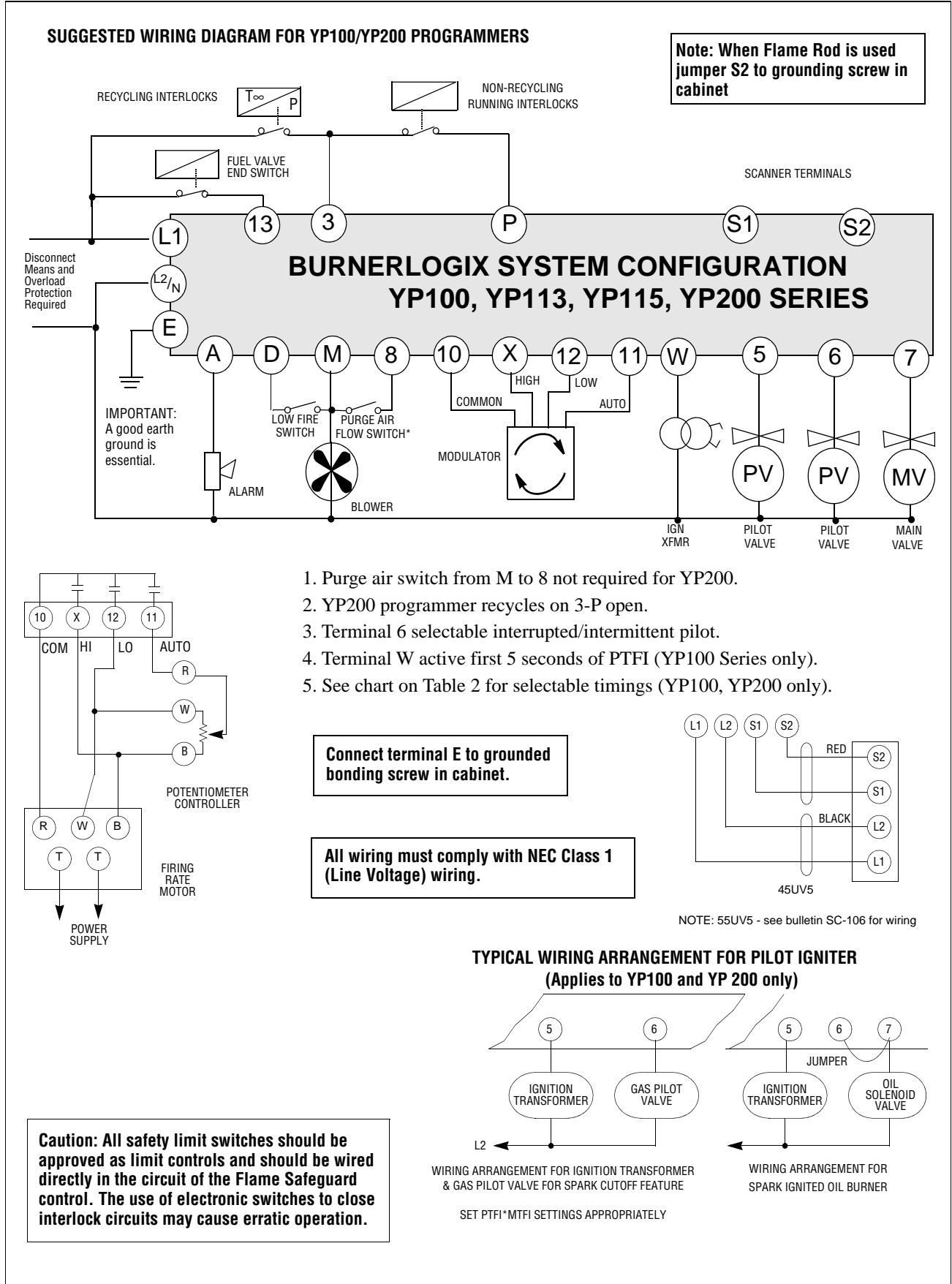

**FIGURE 19. YP300 OPERATING SEQUENCE**

	Programmable Purge Time	PTFI	MTFI	AUTO		Post Purge				
3	Operating control					Programmable Post Purge				
M							Cycle complete			
P										
13 (POC)	Proof of valve closure									
			Don't care state							
X (HI)			5 s Ignition							
12 (LO)										
11 (Auto)										
6 (PV)			10 s	15 s	Usually Intermittent					
5 (IGN)			10 s	10 s						
7 (MV)						5 s Delayed Main Valve				
W(DV)										
8 (HFS)							Don't care state			
D (LFS)										



**FIGURE 20. BURNERLOGIX WIRING DIAGRAM**



1. Purge air switch from M to 8 not required for YP200.
2. YP200 programmer recycles on 3-P open.
3. Terminal 6 selectable interrupted/intermittent pilot.
4. Terminal W active first 5 seconds of PTFI (YP100 Series only).
5. See chart on Table 2 for selectable timings (YP100, YP200 only).

**Connect terminal E to grounded bonding screw in cabinet.**

**All wiring must comply with NEC Class 1 (Line Voltage) wiring.**

POTENTIOMETER CONTROLLER

FIRING RATE MOTOR

POWER SUPPLY

45UV5

NOTE: 55UV5 - see bulletin SC-106 for wiring

**TYPICAL WIRING ARRANGEMENT FOR PILOT IGNITER  
(Applies to YP100 and YP 200 only)**

WIRING ARRANGEMENT FOR IGNITION TRANSFORMER & GAS PILOT VALVE FOR SPARK CUTOFF FEATURE

WIRING ARRANGEMENT FOR SPARK IGNITED OIL BURNER

SET PTFI\*MTFI SETTINGS APPROPRIATELY

**Caution: All safety limit switches should be approved as limit controls and should be wired directly in the circuit of the Flame Safeguard control. The use of electronic switches to close interlock circuits may cause erratic operation.**

**FIGURE 21. YP300 WIRING DIAGRAM**

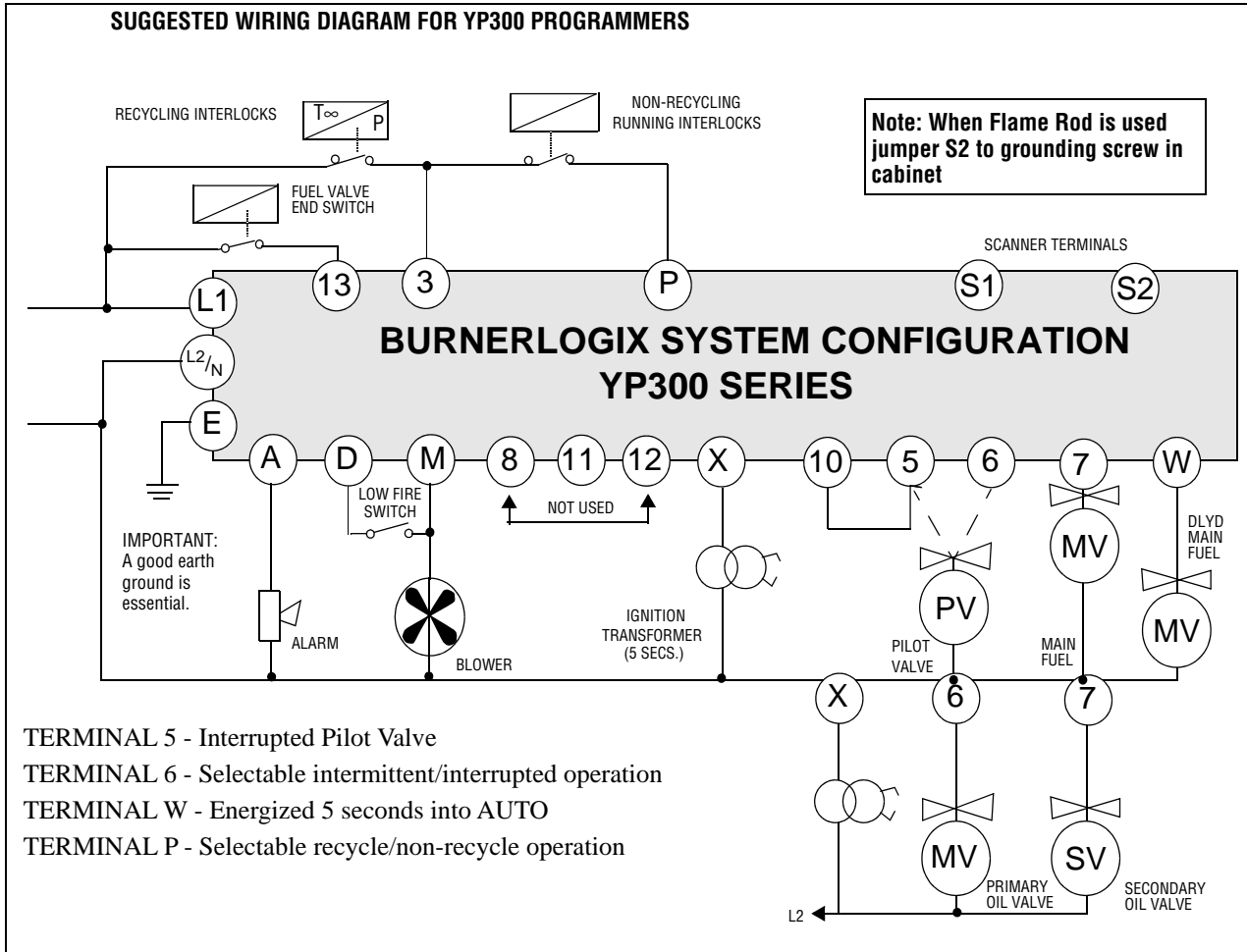

**YP118, YP138 PROGRAMMER**

The YP118 and YP138 programmers offer burner operation similar to the YP100 programmer but with extended functions that might enhance burner operation such as increased turndown. The YP138 programmer makes use of additional inputs on terminals 16 and 21. Both terminals 16 (PILOT HOLD) and 21 (START INPUT) are line voltage inputs.

**FIGURE 22. YP138 WIRING DIAGRAM**

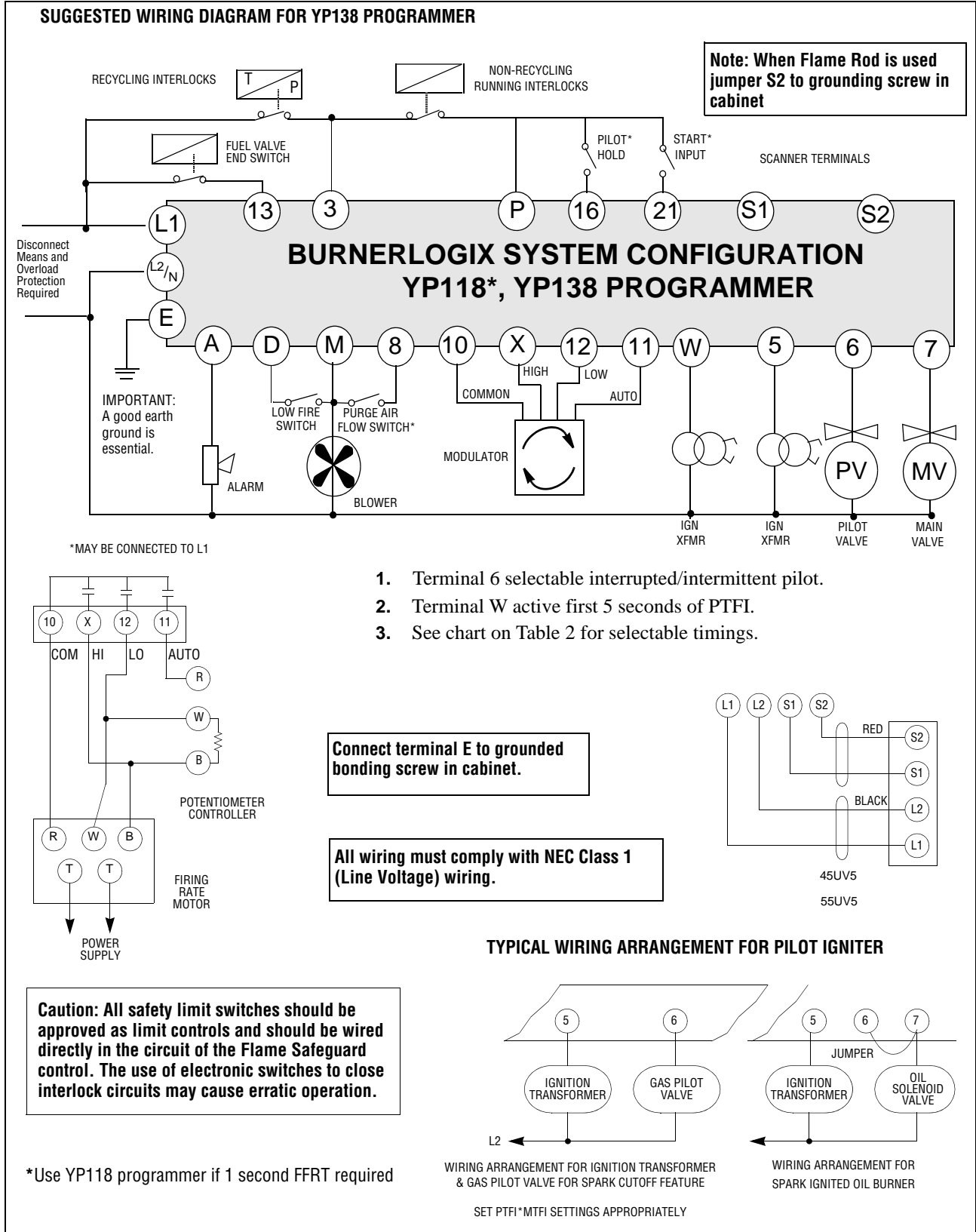



Terminal 21 holds the system indefinitely at the end of low fire start. When opened (off) terminal 21 starts pilot trial for ignition. If the count down method is set, at the end of a low fire start period the display indicates:

**HOLD 00:00**  
**T21 INPUT**

During the AUTO or RUN position, terminal 21 is used to force the firing motor to the low fire position. In this state the display indicates:

**HOLD T21 42** top line indicates hold mode with flame signal  
**LOW FIRE SIGNAL**

Terminal 16 holds the system in a pilot proving state following the pilot trial for ignition period. After pilot trial for ignition, as determined by the PTFI\*MTFI TIMING selection, terminal 5 is de-energized and terminal 6 remains energized. During this state, the system is in a flame proven state. The display indicates:

**PILOT 42** flame signal displayed  
**T16 INPUT** pilot hold period

Once terminal 16 is released (or de-activated), the Burnerlogix proceeds to the MTFI period in accordance with the PTFI\*MTFI TIMINGS selection. If selected, terminal 5 with the ignitor energizes during MTFI.

Terminal 16 is also used to revert the system back to the pilot proving mode from the AUTO or RUN mode. During AUTO, an active state on terminal 16 starts the steps to revert back to pilot mode. On detection of terminal 16, the firing rate motor is commanded to the low fire position and the system waits for the low fire start switch (M-D) to close. While in this wait mode the display indicates:

**HOLD T16 42** while in AUTO, Terminal 16 closes  
**M-D LIMIT OPEN** wait for low fire interlock to close

Once the low fire start switch is detected as closed, terminal 6 is energized to open the pilot valve and terminal 5 is energized to power the ignition transformer. A 20 second time delay is then imposed with both the main valve (7) and pilot valve (6) energized. The display indicates:

**HOLD T16 42** while in AUTO, M-D detected closed  
**M-D LOW LIMIT** wait 20 seconds in this state

At the end of the 20 seconds, the main valve (7) is de-energized and the ignition terminal (5) remains energized for the time specified in PTFI\*MTFI TIMINGS. Terminal W is energized for 5 seconds. The display indicates:

**PTFI 42** flame signal displayed  
**FLAME SIGNAL**

Unlike PTFI, this period is a flame proven state and if flame signal is lost for one FFRT, the system shuts down and locks out. At the end of the selected PTFI time, terminal 5 is de-energized and the Burnerlogix proceeds to the pilot proving period with terminal 6 energized and flame being proven. The display indicates:

**PILOT 42** flame signal displayed  
**T16 INPUT** pilot hold period

*Note: When the main fuel valve is de-energized, its proof-of-closure switch (Fuel Valve End Switch) is expected to close between terminals L1 and L3. If the L1-L3 circuit does not close by the time terminal 5 is de-energized, the control will shut down and display: **LOCKOUT PILOT, T13 FVES OPEN**"*

Once terminal 16 is de-energized, the system proceeds to the MTFI period with terminal 7 (main valve energized). If selected to be on, terminal 5 with the ignitor becomes energized during MTFI in accordance with the PTFI\*MTFI TIMINGS selection. At the conclusion of the MTFI period and as selected by the PTFI\*MTFI TIMINGS selection and terminal 6 as interrupted/intermittent, terminals 5 and 6 assume their respective states.

***Notes on operation:***

While in AUTO or RUN mode, once the action started by T16 begins, it cannot be reversed by opening T16. At the conclusion of PTFI, if T16 is open, the control advances through MTFI to AUTO.

If START INPUT (T21) and PILOT HOLD (T16) are both active in AUTO, T16 has priority and revert to pilot starts.



**The user shall contact the burner manufacturer to determine if the pilot assembly is rated for intermittent operation.**



## LOCKOUTS

When a safety shutdown occurs, the control indicates through the LED's the reason for the lockout. If equipped it displays a lockout message and when in the cycle the lockout occurred. The alarm circuit (Terminal "A") is energized. The non-volatile memory remembers the status of the control even if a power failure occurs. By momentarily depressing and releasing the reset button on the control or the display keypad, the control can be reset. The button must be held down for one second and then released. Very little force is required to do this. Do not press hard.

### SAFETY SHUTDOWN

1. If the running interlock circuit (3-P) does not close, the control locks out and the blower motor is de-energized.

#### PROVING 3-P CLOSED

On cycle start the BurnerLogix proves the 3-P running interlock circuit closed in the following manner:

1. At cycle start (L1-3 closes), if the M-8 damper switch is closed, the pre-purge period begins and the BurnerLogix waits up to 20 seconds for the 3-P circuit to close.
  2. At cycle start (L1-3 closes), if the M-8 damper switch is open, the BurnerLogix waits up to 10 seconds for the 3-P circuit to close after the M-8 circuit closes. Pre-purge timing begins after the M-8 closes circuit closes.
2. If the fuel valve end switch or proof of closure switch connected to Terminal 13 opens during standby or purge, the control locks out.
  3. If the running interlock circuit (3-P) opens during a start-up or firing period, all fuel valves will be de-energized and the control locks out.
  4. If the proven high fire circuit (M-8) has not closed after a ten (10) minute "Hold" period at the start of prepurge, the control locks out.
  5. If the low fire start circuit (M-D) has not closed after a ten (10) minute "Hold" period at the end of prepurge, the control locks out.
  6. a.) If PROVE 3-P OPEN is selected as YES, and the 3-P circuit is closed at the start of the operating cycle, the control holds for thirty (30) seconds waiting for the 3-P circuit to open. If, after thirty (30) seconds, the 3-P circuit does not open, the control locks out.  
b.) If PROVE M-8 OPEN is selected as YES, and the M-8 circuit is closed at the start of a cycle, the control will hold for thirty (30) seconds for it to open. If, after thirty (30) seconds, the M-8 is still closed, the control locks out.  
c.) If PROVE M-D OPEN is selected as YES, and the M-D switch is closed at the end the high fire purge cycle, the control holds for thirty (30) seconds for it to open. If, after thirty (30) seconds, the M-D is still closed, the control locks out.  
d.) If PROVE M-D TFI is selected as YES, the low fire start switch located between terminals M-D must be closed during PTFI and MTFI.
  7. If pilot flame is not detected after the pilot trial for ignition period, the pilot valve and ignition transformer is de-energized and the control locks out on safety.
  8. If main flame is not detected during the main flame trial for ignition period for one FFRT, all fuel valves are de-energized and the control locks out on safety.
  9. If the main flame fails during a firing cycle, all fuel valves are de-energized within 1 FFRT and the control locks out on safety.
  10. If flame is detected when the operating control (L1-3) is open, the control waits sixty (60) seconds and then locks out if flame is still present. If the operating control closes and flame is detected during purge, the control drops back to the Standby position and de-energizes the blower motor (Term M). If the flame signal goes away within sixty (60) seconds, the control proceeds with a normal start-up. If flame signal is still present after sixty (60) seconds, the control locks out.
  11. If the fuel valve end switch connected to Terminal 13 is not closed after 5 seconds into post purge, the control locks out on safety.

**Table 17: DIAGNOSTIC MESSAGES**

MESSAGE	POSSIBLE CAUSE	SOLUTION
<b>CHECK PROGRAMMER</b>	No programmer module plugged into YB chassis/amplifier module	Remove power, insert programmer, press reset to clear fault
	Defective programmer module	Remove power, replace programmer module
<b>CHECK CHASSIS</b>	Relay feedback error caused by bad wiring	Check all wiring, Re-inspect routing of all wires
	Programmer module inserted while power is applied	Cycle power, reset control
	Defective opto-coupler on the YB chassis/amplifier	Replace YB module
<b>CHECK WIRING</b>	Voltage is detected on terminals at improper time	Check system wiring. Measure voltages on input/output terminals
<b>CHECK SCANNER</b>	Flame signal detected during shutter close time in 45UV5 or 55UV5 scanner	Check power on shutter terminals and/or replace shutter in scanner.
	Runaway UV tube	Replace UV tube, part number 4-314-1
<b>CHECK EXPANSION MODULE</b>	Internal diagnostics within expansion module has detected a problem and ceased communications with BurnerLogix control for 3 minutes.	Check that ED580 cable from expansion module to BurnerLogix is plugged in or not damaged, check routing of cable within burner cabinet or check L1-L2 connections to expansion module. Reset control and check STATUS LED on expansion module. Replace YZ300 or YZ320 expansion module or YB110 (YB230) chassis/amplifier module.
	Defective or unplugged ED580 cable.	Assure cable is fully inserted in both BurnerLogix control and Expansion module. Check for damage to cable or connectors.
<b>WAITING FOR DATA</b>	Communications to/from display	Indicates the display is not communicating properly with chassis. Check that the YP programmer is properly inserted. Check that the cable is not defective and is properly inserted into the connectors. In rare instances due to ongoing enhancements to the BurnerLogix family, the display and chassis may not be compatible. Check the date code and engineering code of both sets.

**RESETTING THE CONTROL**

The BurnerLogix systems contains three methods of reset. These are by:

1. push-button located on the YB chassis/amplifier module
2. keypad push-button located on the optional keypad/display module
3. user installed normally open push-button connected from line voltage (L1) to Terminal 22.

Terminal 22 is a line voltage isolated input. Depressing and releasing the reset button is required.







**Notes:**

1. Manual Reset is required following any non-volatile lockout.
2. Depressing and releasing the reset button during a cycle causes the Burnerlogix control to shut the burner down and recycle.
3. The YP113 and YP115 programmers limit the amount of reset attempts to 5 tries. This internal counter gets reset to 0 when the control reaches the AUTO state and on every application of power.

### LOCKOUT CODES

During an alarm condition, the Alarm LED  is made to flash at approximately a twice per second rate. The remaining LED's are illuminated as a coded sequence identifying the reason for the lockout. This remains true if power is removed and then restored in a locked out condition.

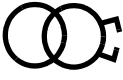
**Table 18: LED LOCKOUT CODES**

LED DISPLAY READOUT ● = ON							
LOCKOUT MESSAGE	FAN	OPEN DAMPER	CLOSE DAMPER	AUTO	IGN	FLAME	
							
T13 FUEL VALVE END SWITCH OPEN					●	●	
M-D LOW FIRE START OPEN				●		●	
M-D LOW FIRE START OPEN - PTFI	●			●		●	
M-D LOW FIRE START OPEN - MTFI	●	●		●		●	
M-D CLOSED			●		●		
M-8 CLOSED			●			●	
M-8 HIGH PURGE CIRCUIT OPEN				●			
FALSE FLAME-STANDBY				●	●		
FLAME FAIL PTFI	●			●	●	●	
FLAME FAIL - MTFI	●	●		●	●	●	
FLAME FAIL AUTO				●	●	●	
3-P RUN INTLK OPEN - PREPURGE	●		●			●	
3-P RUN INTLK OPEN - PURGE	●		●		●		
3-P RUN INTLK OPEN-PTFI	●		●				
3-P RUN INTLK OPEN-MTFI	●	●	●				
3-P RUN INTLK CLOSED-STANDBY						●	
3-P RUN INTLK OPEN-AUTO			●				
FUEL VALVE STATE CHANGE					●		
CHECK FUSE			●	●	●		
CHECK WIRING			●	●		●	
CHECK SCANNER			●		●	●	
CHECK PROGRAMMER			●	●			
CHECK CHASSIS		●					
CHECK EXPANSION MODULE			●	●	●	●	



### LOCKOUT HISTORY SUB-MENU

The sub-menu "LOCKOUT HISTORY" displays the last ten (10) lockouts, along with the burner cycle and burner hour when the lockout occurred. When the MODE key is pressed, the screen displays the most recent lockout condition and the number of that lockout (e.g. LO #10 represents the 10th lockout of that control). The NEXT key displays the Burner Hour, followed by the Burner Cycle when the lockout occurred. The NEXT key advances to the next lockout, and repeats the sequence listed above. The BACK key is used to scroll back up through the sub-menu items. The MODE key exits the sub-menu.

FIGURE 23. LOCKOUT HISTORY

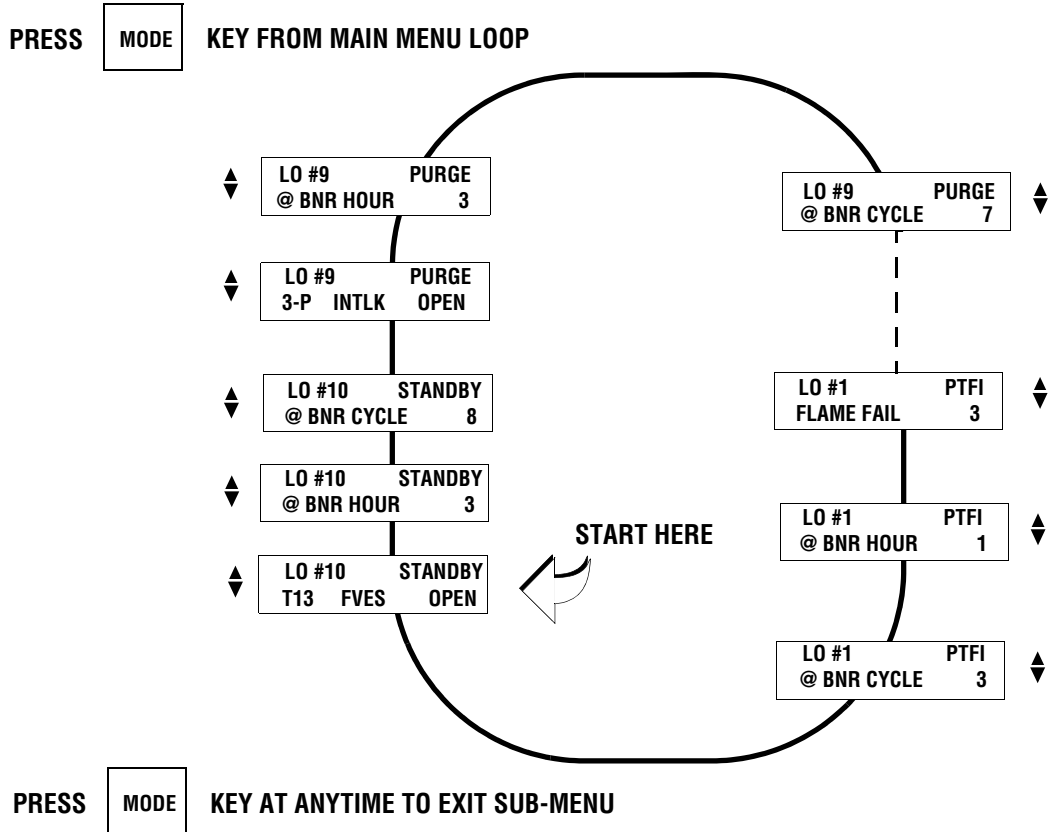

## COMMUNICATIONS

The protocol to be used is Modbus RTU. This is implemented by the master (PC, PLC, etc.) issuing a poll to the slave (BurnerLogix) and the slave responding with the appropriate message.

A typical format of a poll request is as follows:

**Table 19: MESSAGE FORMAT**

DST	FNC	ADR HI	ADR LO	DAT HI	DAT LO	CRC LO	CRC HI
-----	-----	-----------	-----------	-----------	-----------	-----------	-----------

DST refers to the logical address of the slave.

FNC is the function being requested. FNC 03 is a read request.

ADR is the message number or register number of the data being requested.

**For the BurnerLogix all registers are mapped as HOLDING REGISTERS, FNC 03. Register addresses begin at 40001 but is interpreted as address 00.**

DAT is the number of words being requested. A word is an integer consisting of 2 bytes.

The normal response from a slave is as follows:

**Table 20: MODBUS**

DST	FNC	DBC	DATA... Hi/Lo	CRC LO	CRC HI
-----	-----	-----	------------------	-----------	-----------

DBC is the data byte count being returned. It must be two times the DAT number from the poll request.

DATA is the data returned and is always a series of 2 byte integers. If 4 words were requested then DBC would be 8 and there would be 8 data bytes or 4 data words containing the requested data.

**The format of the data is N,8,1 meaning no parity, and 1 stop bit. Baud rate is selectable through the keypad / display. As shipped the baud rate is 9600.**

**FIGURE 24.**

### BOTTOM VIEW COMMS

Communication to the BurnerLogix control is made through either of the RJ-12 jacks located on the underside of the control (note figure on right). The jacks are internally wired in parallel to ease multi-dropping of BurnerLogix controls. The physical method for communications is RS485, half duplex. For each of the RJ-12 connections, the outside contacts are connected together and are designated as "A" or "+" while the inside contacts are connected together and are designated as "B" or "-". Fire-eye supplies the ED512 cables in various lengths with RJ-12 plugs on each end. Refer to bulletin E-8002 for additional information.

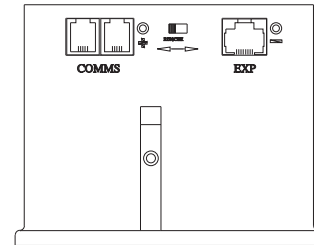

See page 51 for a table of currently available messages provided by the BurnerLogix programmers, followed by a description where necessary

**Table 21: MODBUS MESSAGE TABLE**

HOLDING REGISTER	MESSAGE ADDRESS	WORD REQUESTED	WORD RESPONSE	VALUE
40001	00	1	STATUS	83 (053H) = RUN; 202 (0CAH) = LOCKOUT
40002	01	1	MSGN	Current message being displayed (see Table 25)
40003	02	1	GSTAT	Defines Timer Type
40004	03	1	TIMER	Time in seconds
40005	04	1	FLAME	Flame Signal
40006	05	1	LOGSTAT	Current logic module, PURGE, PTFI, AUTO (see Table 24)
40007	06	1	INPUTS	Input limits state
40008	07	1	OUTPUTS	Output relays state
40009	08	2	SYSMINS	System on minutes
40011	10	2	BNRMINS	Burner on minutes
40013	12	2	CYCLES	Completed Burner Cycles
40015	14	1	LOCKOUT COUNT	Stored Lockout Count
40016	15	6	LOCKOUT HISTORY	Beginning of Last 10 Lockouts
			Most Recent Lockout Data	Returns complete lockout description of stored lockout history.
			2nd Most Recent Lockout Data	
			3rd Most Recent Lockout Data	
			4th Most Recent Lockout Data	
			5th Most Recent Lockout Data	
			6th Most Recent Lockout Data	
			7th Most Recent Lockout Data	
			8th Most Recent Lockout Data	
			9th Most Recent Lockout Data	
40070	69	6	10th Most Recent Lockout Data	Includes lockout message (1), lockout module (1), @ burner hours (2), and @ burner cycles (2)s
40076	75	4		
•	•			
•	•			
•	•			
40079	78			
40080	79	11	N/A	Reserved for Fireye use
•	•			
•	•			
40090	89			
<b>INTERLOCK ANNUNCIATOR</b>				
40901	900	1 - 3	YZ300 Expansion Module registers (see Table 23)	Returns lower, middle and upper interlock annunciator (YZ300) registers.
40902	901	1 - 2		Returns middle and upper interlock annunciator (YZ300) registers.
40903	902	1		Returns upper interlock annunciator (YZ300) register.

**Polling intervals not be less than 200 mSec per request. Requesting data such as burner minutes, system minutes and burner cycles should be kept at a minimum due to the amount of processing time required to gather that data.**

The MSGN being transmitted is a numerical value and must be interpreted by the communicating device, which actually is an advantage since this can be made to be whatever message text the end user wants. In other words, it allows for programming custom messages without actually changing the message in the programmer. Refer to Table 25, for message information.

The BurnerLogix stores its burner on time (7 powered) and system on time (L1 powered) in minutes. For display purposes, the programmer converts this to hours. The information being supplied by Modbus will be the actual time in minutes and it is up to the communicating device to do the conversion. Since the maximum value stored in the BurnerLogix is 9,999,999 minutes, the maximum value in hex therefore is 98967FH and comprises two data words. The maximum cycle count is 999,999 decimal or F423FH, still two data words.



To convert, multiply high word by 10000H (65536), add to this high byte of low word multiplied by 100H (256) and add to this the low byte of low word. Example: (98H\*10000H) + (96H\*100H) + 7FH = 98967FH = 9,999,999 minutes.

As an example, the System on Minutes data is transmitted from the BurnerLogix to the interface as high word / low word as shown below: The same applies to Burner On Minutes and Burner Cycles.

ADDRESS 8		ADDRESS 9	
HIGH WORD		LOW WORD	
HIGH BYTE	LOW BYTE	HIGH BYTE	LOW BYTE
0	98H	96H	7FH

All values are represented in a HEX or base 16 format.

GSTAT determines the type of value TIMER represents. TIMER can be a running timer such as is used in purge, a flame signal or meaningless. Only the lower nibble of GSTAT has any value. If this value is 0 then the TIMER value has no meaning. The value in TIMER is a background minute timer in the BurnerLogix and should be ignored. If GSTAT is between 4 and 7, the TIMER represents the current value flame signal. If GSTAT is a 1, 2, or 3 then TIMER represents a running timer value.

The format of the data is 8 data bits, no parity and 1 stop bit. Due to the RS485 format, the communication format is considered half-duplex. That is, only one user is permitted on the communication lines at a time.

The information contained in INPUTS and OUTPUTS represents the status of the interlocks and output relays respectively. For the INPUTS, a 1 in the interlock position defines the interlock as being on or active where a 1 in any bit position in the OUTPUT register signifies the relay as being energized.

## Table 22: INPUTS AND OUTPUTS

### INPUTS(40007)

Bit 15	Bit 14	Bit 13	Bit 12	Bit 11	Bit 10	Bit 9	Bit 8
AC Line	Term D	Term 16	Term 13	Term 21	Term 22	Term 23	Term 8
Ref	Low Fire Start	Pilot Hold	FVES POC	Start Input	Remote Reset	Spare	Purge Damper

Bit 7	Bit 6	Bit 5	Bit 4	Bit 3	Bit 2	Bit 1	Bit 0
Term P	Term 3	Term M	Term 5	Term 6	Term W	Term 7	KS
Run Interlock	Op Cntrl	Blower	Ignition	Pilot Valve	Delayed Valve	Main Valve	Safety Relay

A '1' in the opto-coupler position indicates the opto-coupler is on or interlock closed.

### OUTPUTS (40008)

Bit 15	Bit 14	Bit 13	Bit 12	Bit 11	Bit 10	Bit 9	Bit 8
				Term A	Term11	Term X	Term 12
				Alarm	Auto*	High Fire	Low Fire*

Bit 7	Bit 6	Bit 5	Bit 4	Bit 3	Bit 2	Bit 1	Bit 0
	IS	Term W	Term 7	Term M	Term 6	Term 5	
	Internal Safety	Delayed Valve	Main Valve	Blower	Pilot Valve	Ignition	

**Note:** A "1" in any bit position indicates the output or terminal is on or active.

**\*Note:** bit 10 is **Low Fire** and bit 8 is **Auto** for YUV, YUVSC, YFR, YDC models

**Table 23: YZ300**

**YZ300 LOWER (40901) – REFER TO BULLETIN YZEM-3001**

Bit 7							Bit 0
Term 47	Term 46	Term 44*	Term 43	Term 3	Term 42	Term 41	Term 40
Low Oil Temp	High Oil Temp	Low Water	High Water	Aux #3	Aux #2	Aux #1	Op Control

\* Terminals 44 and 45 are internally connected

**YZ300 MIDDLE (40902) – REFER TO BULLETIN YZEM-3001**

Bit 7							Bit 0
Term 57	Term 56	Term 55	Term 54*	Term 52	Term 51	Term 49*	Term 48
Aux #4	High Temp	High Pressure	Aux Gas	High Gas Pressure	Low Gas Pressure	Low Atomizing Media	Low Oil Pressure

\* Terminals 49 and 50 are internally connected

\* Terminals 53 and 54 are internally connected

**YZ300 UPPER (40903) – REFER TO BULLETIN YZEM-3001**

Bit 7							Bit 0
				Term P	Term 60	Term 59	Term 58
Unused	Unused	Unused	Unused	Air Flow	Aux #7	Aux #6	Aux #5

\* Unused Bits 4-7 will always return 0

**FIGURE 25. DEFAULT WIRING FOR YZ300 INTERLOCK ANNUNCIATOR**

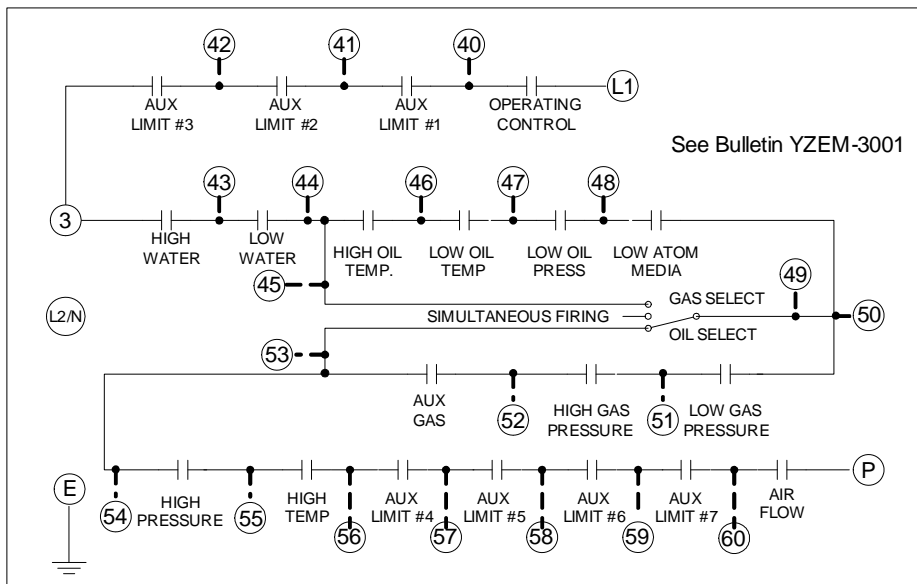



## EXPLANATION OF LOGSTAT

LOGSTAT is an indication of what logic module the control is currently operating in during its cycle and is used for diagnostic purposes only. If a lockout occurs the current value of LOGSTAT is stored as part of the lockout information. The message displayed corresponds to the current logic module.

**Table 24: LOGSTAT**

LOGIC DISPATCHER			
VALUE		MODULE	FUNCTION
DEC	HEX		
1	01H	STANDBY	Idle state
2	02H	BLOWER ON	1/2 second period after operating control closes when blower motor is energized
3	03H	PURGE	Open Damper Purge or waiting for air flow and/or high fire switch to close
4	04H	PURGE	Low Fire Purge
5	05H	PTFI	Pilot Trial for Ignition
6	06H	PTFI	Pilot Trial for Ignition for YP3XX programmers
7	07H	PTFI	If PTFI is greater than 5 seconds and early spark termination is not needed
8	08H	PTFI	If PTFI is greater than 5 seconds and early spark termination is needed
9	09H	PILOT	Pilot Hold, YP138 only
10	0AH	MTFI	Main Trial for Ignition
11	0BH	MTFI	Main Trial for Ignition with terminal 5 de-energized
12	0CH	AUTO	Delayed valve on
13	0DH	AUTO	AUTO
14	0EH	AUTO	On YP138 programmer, hold for 20 seconds with terminals 6 and 7 energized
15	0FH	AUTO	On YP138 programmer, when terminal 21 first energized, wait for M-D to close
16	10H	POSTPURGE	Post Purge
17	11H	POSTPURGE	Post Purge period if flame fail lockout
18	12H	POSTPURGE	Idle state if unit is in lockout

Logstat represents the current software module the BurnerLogix is currently executing.

The BurnerLogix outputs the current displayed message as well as the historical lockout messages as numbers. The table below correlates the message number with the actual displayed text message.



**Table 25: BURNERLOGIX MESSAGES**

DEC	HEX		BURNERLOGIX MESSAGES
1	1	H	T16 M-D LIMIT OPEN - AUTO
2	2	H	HOLD FALSE FLAME- STANDBY
3	3	R	LOW FIRE PURGE
4	4	H	HOLD M-8 LIMIT OPEN- PURGE
5	5	H	See Interlock Annunciation Message Table
6	6	H	T16 M-D LOW LIMIT - AUTO
7	7	L	LOCKOUT FLAME FAIL - PTFI
8	8	H	T16 INPUT
9	9	H	HOLD M-D LIMIT OPEN
10	A	R	IGNITION TIMING - PTFI
11	B	C	CHECK FLAME SIGNAL - MTFI
12	C	R	FLAME SIGNAL - AUTO
13	D	R	CYCLE COMPLETE - POST PURGE
14	E	R	L1-3 OPEN
15	F	H	T21 INPUT
16	10	L	LOCKOUT M-D LIMIT OPEN - PTFI
17	11	L	LOCKOUT M-8 LIMIT OPEN
18	12	L	LOCKOUT M-D LIMIT OPEN
19	13	L	LOCKOUT FLAME FAIL - MTFI
20	14	L	LOCKOUT FALSE FLAME
21	15	L	LOCKOUT 3-P INTLK OPEN (PURGE)
22	16	L	LOCKOUT 3-P INTLK CLOSED
23	17	H	HOLD 3-P INTLK CLOSED - STANDBY
24	18	H	HIGH FIRE PURGE
25	19	L	LOCKOUT M-D LIMIT OPEN - MTFI
26	1A	L	LOCKOUT 3-P INTLK OPEN -AUTO
27	1B	L	LOCKOUT 3-P INTLK OPEN - MTFI
28	1C	L	LOCKOUT 3-P INTLK OPEN - PTFI
29	1D	L	LOCKOUT T13 FVES OPEN
30	1E	L	LOCKOUT 3-P INTLK OPEN - PREPURGE
31	1F	C	CHECK FLAME SIGNAL - PTFI
32	20	C	CHECK M-8 HI LIMIT (HI FIRE PURGE)
33	21	C	CHECK M-D LOW LIMIT (LO FIRE START)
34	22	R	FLAME SIGNAL- PTFI
35	23	C-H	HOLD T21 or CHECK LOW FIRE SIGNAL - AUTO
36	24	R	FLAME SIGNAL - MTFI
37	25	L	LOCKOUT FLAME FAIL (AUTO)
38	26	H	HOLD 3-P INTLK OPEN - PREPURGE
39	27	L	LOCKOUT FUEL VALVE STATE CHANGE
104	68	R	LEARNING FLAME (PTFI and AUTO)



**Table 26: DIAGNOSTIC MESSAGES**

DEC	HEX		BURNERLOGIX MESSAGES
<b>SYSTEM DIAGNOSTIC MESSAGES</b>			
54	36	L	LOCKOUT CHECK CHASSIS
55	37	L	LOCKOUT CHECK PROGRAMMER
56	38	L	See Interlock Annunciation Message Table
57	39	L	LOCKOUT CHECK EXPANSION MODULE
58	3A	L	LOCKOUT CHECK WIRING
59	3B	L	LOCKOUT CHECK FUSE
76	4C	L	LOCKOUT CHECK SCANNER
<b>PURGE INTERLOCK RELATED MESSAGES</b>			
77	4D	H	HOLD M-8 LIMIT CLOSED
78	4E	L	LOCKOUT M-8 LIMIT CLOSED
79	4F	H	HOLD M-D LIMIT CLOSED
80	50	L	LOCKOUT M-D LIMIT CLOSED
81	51		Reserved for future use
82	52		Reserved for future use
83	53	L	LOCKOUT FLAME FAIL - PILOT
84	54	L	LOCKOUT 3-P INTLK OPEN - PILOT
85	55	L	LOCKOUT M-D LIMIT OPEN - PILOT
86	56	L	LOCKOUT T13 FVES OPEN - PILOT
87	57	L	LOCKOUT T13 FVES OPEN - POST PURGE





**Table 27: ANNUNCIATOR MESSAGES**

<b>INTERLOCK ANNUNCIATOR</b>				
<b>DEC</b>	<b>HEX</b>	<b>STATE</b>	<b>TERMINAL</b>	<b>YZ300 INTERLOCK ANNUNCIATOR LOCKOUT MESSAGES</b>
41	29	L	3-43	HIGH WATER
42	2A	L	43-44	LOW WATER
43	2B	L	51-52	HIGH GAS PRESSURE
44	2C	L	50-51	LOW GAS PRESSURE
92	5C	L	52-54	AUX GAS
45	2D	L	47-48	LOW OIL PRESSURE
56	38	L	44-46	HIGH OIL TEMPERATURE
46	2E	L	46-47	LOW OIL TEMPERATURE
47	2F	L	48-50	LOW ATOMIZING MEDIA
48	30	L	54-55	HIGH PRESSURE
49	31	L	55-56	HIGH TEMPERATURE
50	32	L	56-57	AUX #4 OPEN
51	33	L	57-58	AUX #5 OPEN
52	34	L	58-59	AUX #6 OPEN
53	35	L	59-60	AUX #7 OPEN
40	28	L	60-P	AIR FLOW OPEN
<b>DEC</b>	<b>HEX</b>	<b>STATE</b>	<b>TERMINAL</b>	<b>YZ300 INTERLOCK ANNUNCIATOR HOLD MESSAGES</b>
94	5E	H	L1-40	OP CONTROL OPEN
60	3C	H	40-41	L1-3 AUX #1 OPEN
61	3D	H	41-42	L1-3 AUX #2 OPEN
62	3E	H	42-3	L1-3 AUX #3 OPEN
63	3F	H-C	3-43	HIGH WATER
64	40	H-C	43-44	LOW WATER
65	41	H-C	51-52	HIGH GAS PRESSURE
66	42	H-C	50-51	LOW GAS PRESSURE
95	5F	H-C	52-54	AUX GAS
67	43	H-C	47-48	LOW OIL PRESSURE
96	60	H-C	44-46	HIGH OIL TEMPERATURE
68	44	H-C	46-47	LOW OIL TEMPERATURE
69	45	H-C	48-50	LOW ATOMIZING MEDIA
70	46	H-C	54-55	HIGH PRESSURE
71	47	H-C	55-56	HIGH TEMPERATURE
72	48	H-C	56-57	AUX #4 OPEN
73	49	H-C	57-58	AUX #5 OPEN
74	4A	H-C	58-58	AUX #6 OPEN
75	4B	H-C	59-60	AUX #7 OPEN
5	5	H-C	60-P	AIR FLOW OPEN

**R = RUN    H = HOLD    L = LOCKOUT    C = CHECK**

## OPERATIONAL FEATURES

### 4-20 mA TEST JACKS

**FIGURE 26. BOTTOM VIEW 4-20 mA JACKS**

For all amplifier types, the BurnerLogix provides 4-20 mA test jacks to represent the flame signal strength. The test jacks are located on the underside of the YB module (pictured at right). The '+' jack is located next to COMMS port jack and the '-' jack is located next to the EXP port. Use caution so as NOT to plug the '-' jack into the EXP port. The test jacks accept standard plugs having a diameter of 0.078" (2mm). The maximum input impedance allowed is 100 ohms. The chart below correlates the test jack current to the numerical value shown on the display.

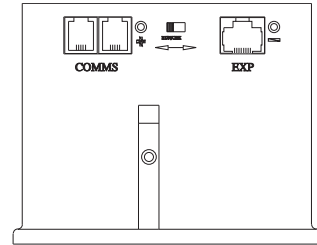

**FIGURE 27. TEST JACKS (4-20 mA) VS. FLAME STRENGTH**

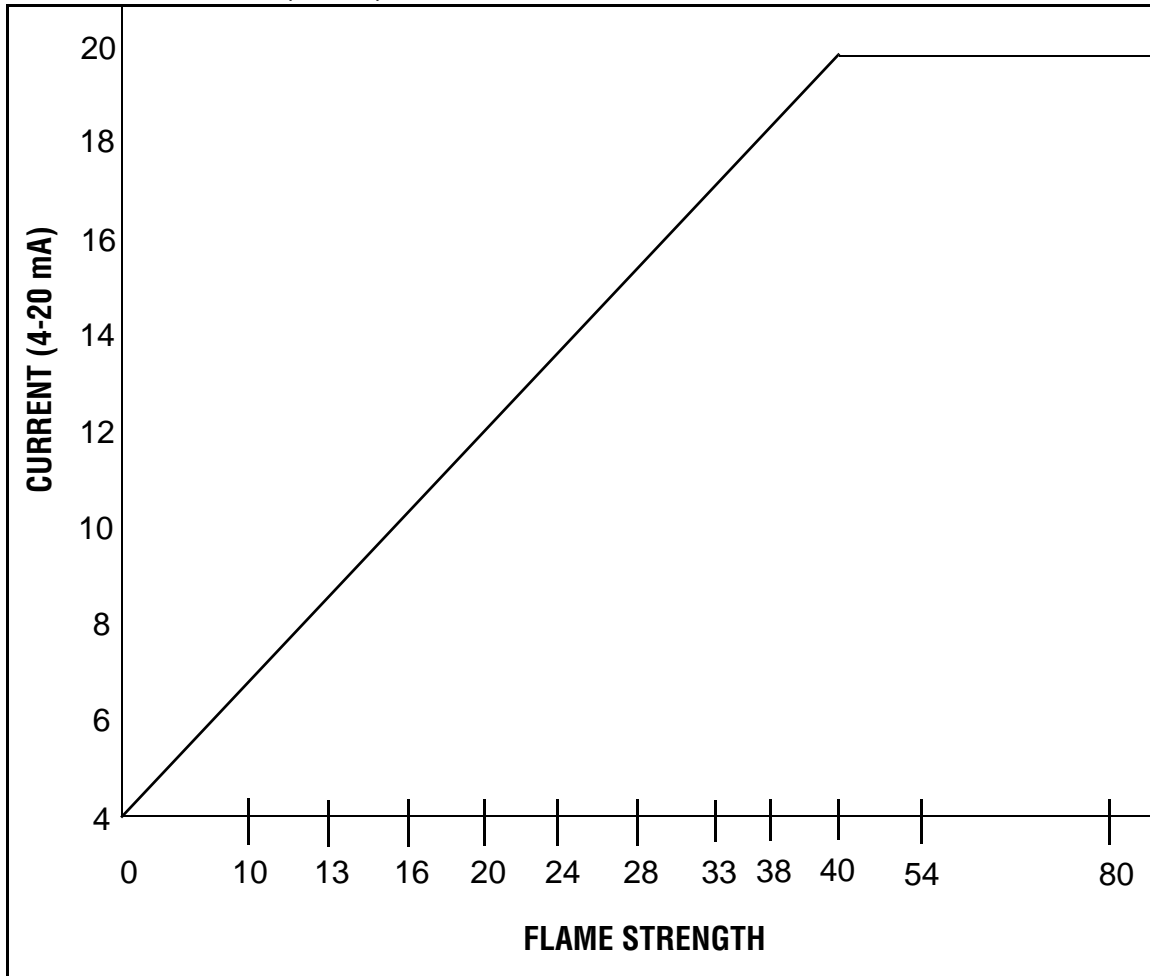

## CHECK-RUN SWITCH

**FIGURE 28. CHECK RUN SWITCH**

The Check-Run switch is located on the underside of the YB Chassis Module (note drawing Fig. 28) and can be used to stop the control in its firing sequence at any time in the burner sequence. It is designed to aid in set-up, start-up and check-out of the burner and its associated interlocks.

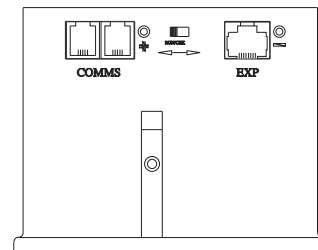

These are the modes of operation:

1. When power is applied to the control terminals (L1-L2) and the operating control circuit is closed (L1-3), the purge period begins and the firing rate motor is sent to the Hi Fire Purge position. If the Check-Run Switch is moved to the Check position before the open damper 30 second purge period ends, the control displays:

**CHECK                    00:24**  
**HIGH FIRE PURGE**

The control holds in this position indefinitely. This allows the operator to make interlock switch and linkage adjustments. To continue the cycle, move the Check-Run switch to Run to allow the control to advance the burner cycle.

2. If the Check-Run switch is moved to the Check position after the open damper purge period, but before low fire start period ends, the control displays:

**CHECK                    00:24**  
**LOW FIRE PURGE**

The control holds in this position indefinitely. This allows the operator to make interlock switch and linkage adjustments. To continue the burner cycle, move the Check-Run Switch to Run. This allows the control to advance.

3. During the PTFI period, switching to the Check position stops the program in the PTFI period, allowing pilot and/or scanner alignment adjustments. The control displays:

**CHECK                    35**  
**FLAME SIGNAL**

It holds in this position indefinitely as long as the flame signal strength is above the threshold of 10. If it drops below 10 for thirty (30) consecutive seconds, lockout occurs and the message on the display reads **Flame Fail PTFI**.

4. During the MTFI period, switching to the Check position stops the Burnerlogix in the MTFI period. To inspect the position of the main flame at the burner head. Depending on where the switch is placed in check and depending on the selection of PTFI\*MTFI TIMING, terminals 5, 6 and 7 can be energized simultaneously. The control displays:

**CHECK                    35**  
**FLAME SIGNAL**

If the unit is left in Check for longer than 2 minutes, the control automatically advances to AUTO.

5. Switching from run to check during the burner on period drives the modulator circuit to low fire (10-12 Closes). This allows for low fire fuel-air adjustments, holding the burner at low fire. Consult your boiler/burner instructions for low fire hold firing recommendations. The control displays:

**CHECK                    35**  
**LOW FIRE SIGNAL**

## OPERATIONAL TEST (BURNER COMMISSIONING)



**WARNING:** Before testing the Burnerlogix operation on the boiler, close the manual main shut-off fuel valve. Failure to do this may cause injury or property damage.

### Close the manual main shut-off fuel valve.

1. Recheck all limit circuit wiring for proper operation and correct connection.
2. Confirm that the automatic main fuel valves are wired to terminal “7.”
3. Power the control and electronically check the proper sequence of operation according to the System Operation section on page 36 of this bulletin.
4. After assuring yourself that all interlocks and valves are properly wired and that the sequence of operation is correct, open the manual main shut-off fuel valve and proceed cautiously through the boiler light off process. Check all safety interlocks for proper shut down of the boiler.

When the installation and all burner adjustments are completed, the entire burner control system is tested in accordance with the burner manufacturer’s instructions. The procedure should verify the correct operation of:

1. Each operating control (temperature, pressure, etc.).
2. Each limit switch (temperature, pressure, low water cutoff, etc.).
3. Each interlock switch (airflow switch, high and low fuel pressure or temperature switches, purge and low fire start switches, fuel valve proof of closure interlock, etc.).
4. Pilot flame failure response and lockout.
5. Main flame failure response and lockout.
6. Tight shut off of all fuel valves.



**CAUTION:** Live voltage is necessary to perform this test.

### Line Voltage Test

A Voltage Check is necessary to identify a potential problem with the supply to the control. This could be caused by an improperly sized or faulty transformer, faulty load coils or low entry voltage. Follow this procedure:

1. Monitor the L1-L2 mains supply throughout a complete burner cycle. The acceptable voltage range is 102V-132V (211VAC to 253VAC). At no time during the cycle can the voltage dip below the minimum level.
2. Check other load terminals (M/L2, 5/L2, 6/L2, 7/L2) for voltage occurring at improper times or improper values.

## TEST CHECKOUT PROCEDURES

### Normal Pilot Flame Test



**CAUTION:** Before making a pilot flame test, manually shut off the fuel supply to the main burner so only the PILOT valve is operating.

1. At the start of PTFI, place the RUN/CHK switch in the CHK position.
2. Observe the pilot flame signal on the display or meter. If the average signal is below the minimum of 10, readjust the pilot flame or realign the flame detector.
3. During the pilot flame test, if flame is not detected for a continuous 30 seconds, the control locks out. To re-establish the pilot flame trial for ignition (PTFI), manual reset of the lockout switch is required, and a complete prepurge must be done.

4. When UV flame detection is used, a test is required to verify that UV radiation from the ignition spark is not being detected. To accomplish this, manually shut off both pilot and main fuels. Initiate a normal start-up, and when the PTFI display comes on, observe the display which should read no signal more than 4. If more than 4 is observed, realign the UV scanner, and/or shield the spark from the scanner's view.
5. With all methods of flame detection, check pilot flame failure response by manually shutting off the pilot fuel and then initiate a normal start-up. With no pilot flame present, the control will de-energize the pilot assembly at the end of the trial for ignition interval, and the control will lock-out. Also check to verify that the ignition spark does not cause an electrical interference on infrared or flame rod applications.

#### **Main Flame Test**

*Note: This test requires an interrupted pilot (a pilot that shuts off after main flame has been established).*

1. Proceed through a normal startup. After the pilot flame is shut off, observe the reading on the display. If the signal reading is low, readjust main flame or realign detector.
2. Check main flame failure protection by manually shutting off the main fuel supply. Within 4 seconds after main flame goes out, the fuel valve will be de-energized. The alarm circuit will be energized following safety lockout.



**CAUTION: The minimum pilot test must be accomplished by a trained and qualified burner technician**

#### **Minimum Pilot Test (Pilot turn down test)**

This test assures that the flame detector will not detect a pilot flame too small to reliably light off the main flame. The test should be made on every new installation and following any repositioning or replacement of the flame detector. This procedure should not be used on a direct spark ignited burner.

1. Turn off the main fuel supply manually.
2. At the start of PTFI, place the Check-run switch in the check position.
3. Reduce the pilot fuel supply until the display reads below 10.
4. Slowly increase the fuel to the pilot until the display reads 10. This is minimum pilot flame that the flame detector will reliably detect.
5. Place the Check-run switch in the Run position. When the main fuel safety shut-off valve is energized, slowly open the manual main fuel valve.
6. Observe the light-off of the main flame. It must be smooth and normal.



**CAUTION: If the main flame does not ignite immediately, shut off the main fuel. Realign the detector to require larger minimum pilot flame**

7. Repeat this test until a reliable and smooth light-off occurs with the minimum pilot.
8. After this test is completed, increase the fuel to the pilot to its normal setting.

**FIGURE 29. PILOT FLAME TEST**

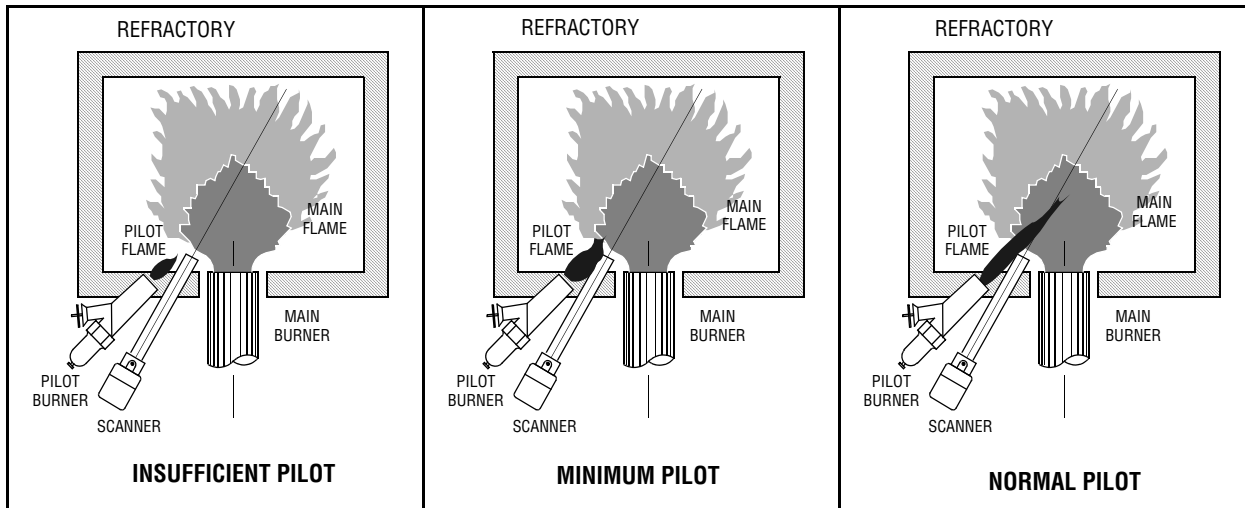

### Scanner Wiring

Take care to see that ignitor cables and scanner cables are routed away from one another on all installations. These cables, when crossed or run together, may interfere with the proper operation of the Burnerlogix control.

If you are experiencing erratic operation or inappropriate characters on the display during the trial for ignition period, the cause is likely to be ignitor noise. Check for worn ignitor cable insulation, broken or cut insulation or loose connectors at the electrode and transformers

### BURNERLOGIX GROUNDING RULES

The BurnerLogix system, is microprocessor based and requires a ground system that provides a zero-voltage reference. The voltage measured from L2 to all other terminals except L1 should be 0 volts.

1. The most effective ground is to run the ground wire in the same raceway as the hot and neutral from the main distribution service panel (not intermediate sub-panels) to the burner control panel and insure that this ground wire is well bonded to the control panel.
2. The wiring base of the BurnerLogix must have earth ground providing a connection between the sub-base and the control panel or the burner.
3. The earth ground wire must be capable of conducting the current to blow the 20A fuse in event of an internal short circuit. A number 14 AWG copper conductor is adequate, wide straps or brackets are preferred rather than lead wires.
4. The ground path needs to be low impedance (less than 1 ohm) to the equipment frame which in turn needs a low impedance to earth ground. For a ground path to be low impedance at RF frequencies, the connection must be made with minimum length conductors having maximum surface areas.
5. All connections should be free of nonconductive coatings and protected against rust.
6. Utilizing conduit as a means of providing a ground must be avoided.
7. Installing ground rods at the burner control panel defeats the purpose of a single point ground as described above and could also present a safety hazard.

### INSTALLATION

Do not run high voltage ignition transformer wires in the same conduit with flame detection wiring. Do not run scanner wires in a conduit with line voltage circuits. Ensure the frame of the ignition transformer is securely connected to control panel frame or preferably the burner frame.

The BurnerLogix chassis (YB110/YB230) contains a transient suppressing device connected internally across hot and neutral and to earth ground, terminal E. For this to be effective terminal E or the green wire in the pig-tail wiring base must be grounded well.



## REMOTE DISPLAY

To locate the display remotely from the BurnerLogix control, mounting kits are available. These are Fireye part numbers 129-178-4 or 129-178-8. Each kit contains a gasket, hardware to mount the display and a 4 or 8 foot cable.

Care must be taken not to route the ED580 cable in close proximity to any starter motor contactors located in the control panel or across any high voltage ignition wires. Refer to Fireye bulletin E-8002 for proper installation.

## COMMUNICATIONS

When interfacing Fireye controls to a communication system, be it a PLC or other microprocessor based device, ferrite cores should also be utilized. Proper twisted shielded pair cable must be utilized. In a multi-drop system, the shields should be tied together within a cabinet and not to any ground point. The shield at the source end of the cable of the multi-drop connection can then be terminated to ground. Source end is defined as the originating end of the communication system

Care must be taken not to route communication cables in close proximity to any starter motor contactors located in the control panel or across any high voltage ignition wires. Refer to Fireye bulletin E-8002 for proper installation.

## SCANNERS

The armored cable supplied with the Ultra-Violet and Infrared scanners should be connected to equipment by means of a good mechanical connection such as a conduit fitting. It may be necessary to utilize heat insulator (P/N 35-69) to isolate the sensing end of the scanner from boiler ground. Care must be taken not to route the scanner cable across the high voltage ignition cable. The high energy ignition cable should be checked periodically for cracking, connections and aging.

In applications using flame rod units, it may be beneficial to route a separate return wire from the S2 terminal to the flame rod assembly. This will minimize the effects of transient currents flowing into the BurnerLogix.

In all cases, scanner wires should be routed in separate conduit and not joined with any high voltage AC or ignition cables.

## MAINTENANCE

Periodically, the spark electrode should be inspected for proper gapping and cracked ceramics. At ignition time, the high energy from the ignition transformer will attempt to conduct to the point of least resistance and with an improper spark gap, where the conduction takes place will no longer be controlled.

The VA rating of the control transformer must be sized to handle the inrush currents of the pilot solenoid and ignition transformer at PTFI and then the inrush currents of the main fuel valve assembly at MTFI time.

Inspect neatness of wiring in junction boxes and cabinets. It is best to have connections short and direct and also not having wires bunched up and tied off. Also, connections should be periodically inspected for tightness and corrosion

Type 48PT2 Infrared and Type UV1A, UV2, 45UV5 Ultra-violet Scanners

The viewing area of the scanner must be kept clean. Even a small amount of contamination will reduce the flame signal reaching the detector by a measurable amount. Wipe the viewing area routinely using a soft cloth dampened with concentrated detergent.

— Type 48PT2 Scanners include a replaceable #4-263-1 Firetron cell.

— Type 45UV5 Scanners include a replaceable #4-314-1 UV tube.

### Type 69ND1 Flame Rod

The flame rod and its insulator should be kept clean by washing routinely with soap and water. Rods should be routinely replaced as they oxidize.



### Flame Signal Strength

Routine observation of the flame signal strength will forewarn any deterioration in the capability of the flame detector or its application.

### Contacts

There are no accessible contacts in the BurnerLogix. Where contacts are used, their design assures long trouble-free life when the load circuits are maintained within the published load ratings.

### Humidity

In areas of high humidity, the control chassis should be removed and placed in a dry atmosphere when the system is expected to be out of service for an extended period.

### Periodic Safety Check

It is recommended that a procedure be established to test the complete flame safeguard system at least once a month. This test should verify the proper operation of all limit switches and safety interlocks as well as flame failure protection and fuel safety shutoff valve tightness.

### Rotation

It is recommended that control and scanner units purchased as spares be installed periodically to ensure proper operation.

---

## NOTICE

When Fireeye products are combined with equipment manufactured by others and/or integrated into systems designed or manufactured by others, the Fireeye warranty, as stated in its General Terms and Conditions of Sale, pertains only to the Fireeye products and not to any other equipment or to the combined system or its overall performance.

---

## WARRANTIES

FIREYE guarantees for *one year from the date of installation or 18 months from date of manufacture* of its products to replace, or, at its option, to repair any product or part thereof (except lamps and photocells) which is found defective in material or workmanship or which otherwise fails to conform to the description of the product on the face of its sales order. **THE FOREGOING IS IN LIEU OF ALL OTHER WARRANTIES AND FIREYE MAKES NO WARRANTY OF MERCHANTABILITY OR ANY OTHER WARRANTY, EXPRESS OR IMPLIED.** Except as specifically stated in these general terms and conditions of sale, remedies with respect to any product or part number manufactured or sold by Fireeye shall be limited exclusively to the right to replacement or repair as above provided. In no event shall Fireeye be liable for consequential or special damages of any nature that may arise in connection with such product or part.



FIREYE®  
3 Manchester Road  
Derry, New Hampshire 03038 USA  
[www.fireeye.com](http://www.fireeye.com)

BL-1001  
August 7, 2018  
Supersedes January 26, 2017