

SIEMENS



Radar Transmitters

SITRANS LR200 (HART)

Quick Start Manual

Edition

11/2016

SITRANS LR200 (HART) Quick Start Manual

This manual outlines the essential features and functions of the SITRANS LR200 (HART). We strongly advise you to acquire the detailed version of the manual so you can use your device to its fullest potential. The complete manual can be downloaded from the SITRANS LR200 product page of our web site at: www.siemens.com/LR200. The printed manual is available from your local Siemens Milltronics representative.

Questions about the contents of this manual can be directed to:

Siemens Milltronics Process Instruments
1954 Technology Drive, P.O. Box 4225
Peterborough, Ontario, Canada, K9J 7B1
Email: techpubs.smpi@siemens.com

**Copyright Siemens Milltronics
Process Instruments 2013.
All Rights Reserved**

Disclaimer of Liability

We encourage users to purchase authorized bound manuals, or to view electronic versions as designed and authored by Siemens Milltronics Process Instruments. Siemens Milltronics Process Instruments will not be responsible for the contents of partial or whole reproductions of either bound or electronic versions.

While we have verified the contents of this manual for agreement with the instrumentation described, variations remain possible. Thus we cannot guarantee full agreement. The contents of this manual are regularly reviewed and corrections are included in subsequent editions. We welcome all suggestions for improvement.

Technical data subject to change.

MILLTRONICS is a registered trademark of Siemens Milltronics Process Instruments

Technical Support

Support is available 24 hours a day.

To find your local Siemens Automation Office address, phone number, and fax number, go to:

www.siemens.com/automation/partner:

- Click on the tab **Contacts by Product** then find your product group (**+Process Automation > +Process Instrumentation > +Level Measuring Instruments**).
- Select the team **Technical Support**. Click on **Next**.
- Click on a continent, then a country, followed by a city. Click on **Next**.

For on-line technical support go to: www.siemens.com/automation/support-request

- Enter the device name (SITRANS LR200) or order number, then click on **Search**, and select the appropriate product type. Click on **Next**.
- Enter a keyword describing your issue. Then either browse the relevant documentation, or click on **Next** to email a description of your issue to Siemens Technical Support staff.

Siemens IA/DT Technical Support Center: phone +49 (0)911 895 7 222

Safety Guidelines

Warning notices must be observed to ensure personal safety as well as that of others, and to protect the product and the connected equipment. These warning notices are accompanied by a clarification of the level of caution to be observed.



WARNING symbol relates to a caution symbol on the product, and means that failure to observe the necessary precautions can result in death, serious injury, and/or considerable material damage.



WARNING symbol, used when there is no corresponding caution symbol on the product, means that failure to observe the necessary precautions can result in death, serious injury, and/or considerable material damage.

Note: means important information about the product or that part of the operating manual.

FCC Conformity

US Installations only: Federal Communications Commission (FCC) rules



WARNING: Changes or modifications not expressly approved by Siemens Milltronics could void the user's authority to operate the equipment.

Notes:

- This equipment has been tested and found to comply with the limits for a Class A digital device, pursuant to Part 15 of the FCC Rules. These limits are designed to provide reasonable protection against harmful interference when the equipment is operated in a commercial environment.
- This equipment generates, uses, and can radiate radio frequency energy and, if not installed and used in accordance with the instruction manual, may cause harmful interference to radio communications. Operation of this equipment in a residential area is likely to cause harmful interference to radio communications, in which case the user will be required to correct the interference at his own expense.

SITRANS LR200



WARNING: SITRANS LR200 is to be used only in the manner outlined in this manual, otherwise protection provided by the equipment may be impaired.

Note: This product is intended for use in industrial areas. Operation of this equipment in a residential area may cause interference to several frequency based communications.

SITRANS LR200 is a 2-wire 6 GHz pulse radar level transmitter for continuous monitoring of liquids and slurries in storage and process vessels including high temperature and pressure, to a range of 20 m (66ft).

The device consists of an electronic circuit coupled to the antenna and either a threaded or flange type process connection.

SITRANS LR200 supports HART[®] ¹⁾ communication protocol and SIMATIC PDM software. Signals are processed using Process Intelligence.

Specifications

For a complete listing, see the SITRANS LR200 (HART) Instruction Manual. For Approvals information see *Approvals* on page 3.

¹⁾ HART[®] is a registered trademark of HART Communication Foundation.

Ambient/Operating Temperature

Notes:

- Process temperature and pressure capabilities are dependent upon information on the process device tag. The reference drawing listed on the tag can be downloaded from the Siemens website at: www.siemens.com/LR200 under **Support**.
- Maximum temperature is dependent on the process connection, antenna materials, and vessel pressure. See *Maximum Process Temperature Chart* on page 19, for more details. Process Pressure Temperature derating curves are available in the full manual.

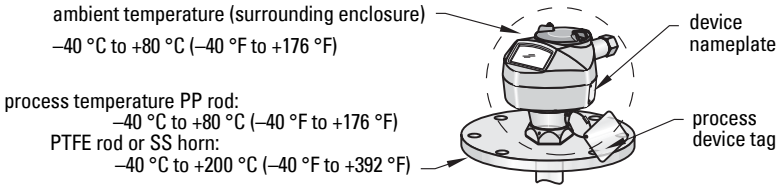

Power



General Purpose:

Intrinsically Safe:

Non-Sparking

Non-incendive (FM/US only):

Nominal 24 V DC at
max. 550 Ohm loop
resistance¹⁾



Flameproof:

Increased Safety:

Explosion-proof (FM/CSA US/Canada only):

Nominal 24 V DC at
max. 250 Ohm loop
resistance¹⁾

Approvals

Notes:

- Refer to the device nameplate and the process device tag to check the approval rating of your device.
- Use appropriate conduit seals to maintain IP or NEMA rating.

• General	CSA _{US/C} , FM, CE, C-TICK	
• Radio	Europe (RED), FCC, Industry Canada	
• Hazardous	Intrinsically Safe ²⁾ (Europe)	ATEX II 1 G Ex ia IIC T4 Ga
	(International)	IECEx SIR 13.0006X, Ex ia IIC T4 Ga
	US/Canada)	FM/CSA:
		Class I, Div. 1, Groups A, B, C, D
		Class II, Div. 1, Groups E, F, G
		Class III T4

¹⁾ Check the device nameplate for the characteristics of the device, and confirm the loop load.

²⁾ See *Intrinsically Safe wiring* on page 8.

Note: Use appropriate conduit seals to maintain IP or NEMA rating.

- Hazardous (continued)

	(Brazil)	INMETRO DNV 12.0143X Ex ia IIC T4 Ga IP67/IP68 -40 °C ≤ Ta ≤ +80 °C DNV #OCP 0017 ABNT NBR IEC 60079-0:2008, ABNT NBR IEC 60079-11:2009 e ABNT NBR IEC 60079-26:2008
	(China)	NEPSI Ex ia IIC T4 Ga
Non-Sparking ¹⁾	(Europe)	ATEX II 3 G Ex nA IIC T4 Gc
	(China)	NEPSI Ex nA IIC T4 Gc
Non-Incendive ²⁾	(US)	FM: Class I, Div. 2, Groups A, B, C, D, T5
Flameproof ³⁾	(Europe)	ATEX II 1/2 G Ex d mb ia IIC T4 Ga/Gb
	(China)	NEPSI Ex d ia mb IIC T4 Ga/Gb
Increased Safety ⁴⁾	(Europe)	ATEX II 1/2 G Ex e mb ia IIC T4 Ga/Gb
	(China)	NEPSI Ex e ia mb IIC T4 Ga/Gb
Explosion proof ⁵⁾	(US/Canada)	FM/CSA: (barrier not required) Class I, Div. 1, Groups A, B, C, D Class II, Div. 1, Groups E, F, G Class III T4
- Marine Lloyd's Register of Shipping
ABS Type Approval

Installation



WARNINGS:

- Installation shall only be performed by qualified personnel and in accordance with local governing regulations.
- Materials of construction are chosen based on their chemical compatibility (or inertness) for general purposes. For exposure to specific environments, check with chemical compatibility charts before installing.
- Handle the device using the enclosure, not the antenna or the device tag, to avoid damage.
- Close the cable inlets for the electrical connections. Only use cable glands or plugs which are approved for the relevant type of protection.

Notes:

- The Process Device Tag shall remain with the process pressure boundary assembly¹⁾. In the event the device package is replaced, the Process Device Tag shall be transferred to the replacement unit.
- SITRANS LR200 units are hydrostatically tested, meeting or exceeding the requirements of the ASME Boiler and Pressure Vessel Code and the European Pressure Equipment Directive.

¹⁾ See *Non-Sparking wiring* on page 9.

²⁾ See *Non-incendive wiring (FM US only)* on page 9.

³⁾ See *Flameproof wiring* on page 10.

⁴⁾ See *Increased safety wiring* on page 10.

⁵⁾ See *Explosion-proof wiring (FM/CSA US/Canada only)* on page 10.

⁶⁾ The process pressure boundary assembly comprises the components that act as a barrier against pressure loss from the process vessel: that is, the combination of process connection body and emitter, but normally excluding the electrical enclosure.

Pressure Application



WARNINGS:

- **Never attempt to loosen, remove, or disassemble process connection or instrument housing while vessel contents are under pressure.**
- **Improper installation may result in loss of process pressure.**

Pressure Equipment Directive, PED, 97/23/EC

Siemens Level Transmitters with flanged, threaded, or sanitary clamp type process mounts have no pressure-bearing housing of their own and, therefore, do not come under the Pressure Equipment Directive as pressure or safety accessories, (see EU Commission Guideline 1/8).

Nozzle design

Notes:

- For nozzles 100 mm (4") in length or shorter use the 100 mm (4") shield.
- For nozzles 250 mm (10") in length or shorter use the 250 mm (10") shield.
- For horn and waveguide versions see the full manual which can be downloaded from www.siemens.com/LR200.
- The end of the shield section should protrude a minimum of 10 mm (0.4") to avoid false echoes being reflected from the nozzle.

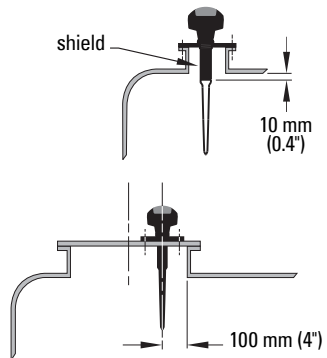

Location on a manhole cover

- A manhole cover is typically a covered nozzle with a diameter 610 mm (24") or greater.
- For optimum signal conditions, locate the antenna off-center, typically 100 mm (4") from the side.

Nozzle location



WARNING: For vessels with conical or parabolic tops, avoid mounting the instrument at the centre. (The concavity of the top can focus echoes into the centre, giving false readings.)

Note: Under certain circumstances, it may be acceptable to mount the device at the centre of a flat-topped tank. Please discuss this with your local Siemens representative.

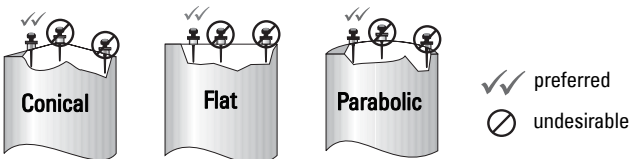

Environment

- Provide an environment suitable to the housing rating and materials of construction.
- Provide a sunshield if the device will be mounted in direct sunlight.

Access for programming

- Provide easy access for viewing the display and programming via the hand programmer.

Nozzle location

Beam angle

- Beam angle is the width of the cone where the energy density is half of the peak energy density.
- The peak energy density is directly in front of and in line with the antenna.
- There is a signal transmitted outside the beam angle, therefore false targets may be detected.

Emission Cone

- Keep emission cone free of interference from ladders, pipes, I-beams or filling streams.
- Locate the antenna away from the side wall, to avoid interference from indirect echoes.
- Make allowance for the emission cone spreading.

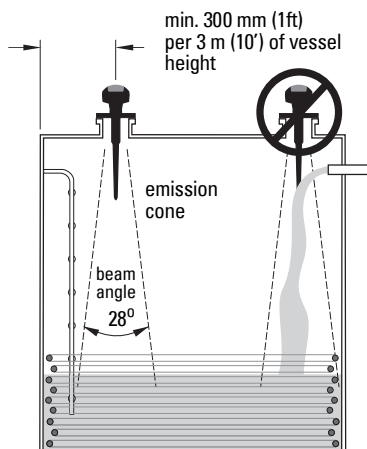

Mounting instructions

- ! WARNING:** For pressure applications, use PTFE tape or other appropriate thread sealing compound, and tighten the process connection beyond hand-tight (max. torque 40 N·m (30 ft.lbs)).

Notes:

- There is no limit to the number of times the device can be rotated.
- Orient the front or back of the device towards the closest vessel wall.
- Do not rotate the enclosure after programming and device configuration (a polarity shift of the transmit pulse may cause an error).

Threaded Version

- 1) Before inserting the device into its mounting connection, check to ensure the threads are matching to avoid damaging them.
- 2) Screw the device into the process connection, and hand tighten.
- 3) To rotate the enclosure, first loosen the three set-screws securing the locking ring. After positioning the enclosure, retighten the screws.

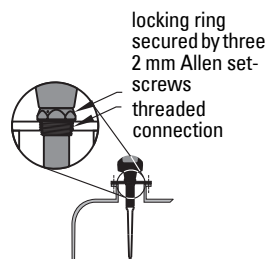

Flanged Version

- ! WARNING:** The user is responsible for the selection of bolting and gasket materials which will fall within the limits of the flange and its intended use, and which are suitable for the service conditions.

WARNINGS:



The DC input terminals shall be supplied from a source providing electrical isolation between the input and output, in order to meet the applicable safety requirements of IEC 61010-1.



All field wiring must have insulation suitable for rated voltages.

Connecting SITRANS LR200



WARNINGS:

- Check the device nameplate and process device tag, to verify the approval rating.
- Use appropriate conduit seals to maintain IP or NEMA rating.
- Read *Instructions specific to hazardous area installations* on page 11.

Notes:

- For detailed wiring instructions, please refer to the full Instruction Manual.
- Use twisted pair cable: AWG 22 to 14 (0.34 mm² to 2.5 mm²).
- Separate cables and conduits may be required to conform to standard instrumentation wiring practices, or electrical codes.

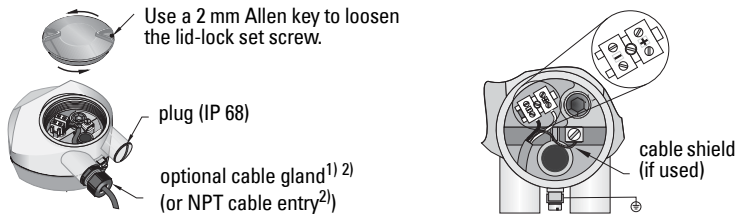

- 1) Strip the cable jacket for approximately 70 mm (2.75") from the end of the cable, and thread the wires through the gland.
- 2) Connect the wires to the terminal as shown: the polarity is identified on the terminal block.
- 3) Ground the device according to local regulations.
- 4) Tighten the gland to form a good seal.
- 5) Close the lid and secure the locking ring before programming and device configuration. Do not rotate the device after it has been configured, as this may cause an error.

¹⁾ May be shipped with the device.

²⁾ If cable is routed through conduit, use only approved suitable-size hubs for waterproof applications.

Connecting HART: typical PLC/mA configuration

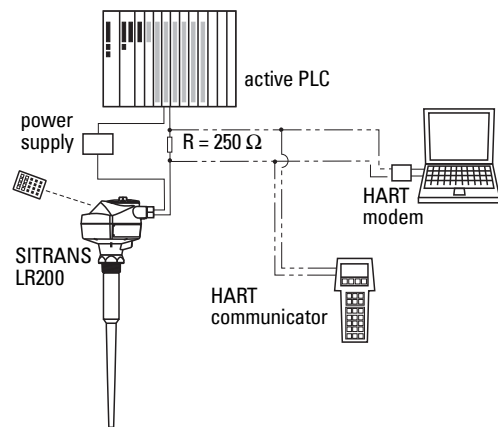

Notes:

- Depending on the system design, the power supply may be separate from the PLC, or integral to it.
- HART resistance (cable resistance plus 250 Ohm [resistor]) must be limited according to the allowable operating area¹⁾.
- Do not connect more than one HART programming device at a time.

Wiring setups for hazardous area installations

Note: ATEX certificates and connection drawings listed below can be downloaded from the product page of our website at: www.siemens.com/LR200.

There are six wiring options for hazardous area installations. In all cases, check the device nameplate and process device tag to verify the approval rating.

1. Intrinsically Safe wiring

Device nameplate (ATEX/IECEX/INMETRO/C-TICK)

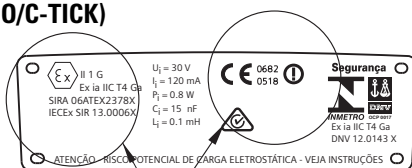
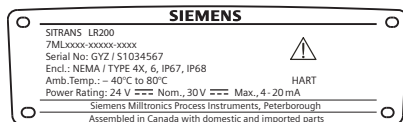

The ATEX certificate can be downloaded from the product page of our website at: www.siemens.com/LR200. Go to **Support > Approvals / Certificates**.

The IECEx certificate listed on the nameplate can be viewed on the IECEx website. Go to: <http://iecex.iec.ch> and click on **Ex Equipment Certificates of Conformity** then enter the certificate number IECEx SIR 13.0006X.

¹⁾ See *Curve 1: General Purpose, Intrinsically Safe, Non-Sparking, Non-incendive* on page 20 or *Curve 2: Flameproof, Increased Safety, Explosion-proof* on page 20.

Device nameplate (FM/CSA)

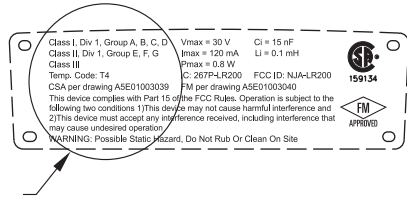
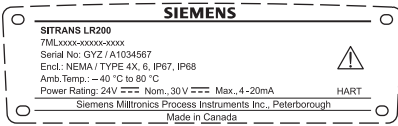

FM Intrinsically Safe connection drawing number **A5E01003040** and CSA Intrinsically Safe connection drawing number **A5E01003039** can be downloaded from the product page of our website at: www.siemens.com/LR200. Go to **Support > Installation Drawings > Level Measurement > Continuous - Radar**.

- For power demands see *Curve 1: General Purpose, Intrinsically Safe, Non-Sparking, Non-incendive* on page 20.
- For wiring requirements: follow local regulations.
- Approved dust-tight and water-tight conduit seals are required for outdoor NEMA 4X / type 4X / NEMA 6, IP67, IP68 locations.
- Refer to *Instructions specific to hazardous area installations* on page 11 and the ATEX certificate listed above.

Note: Selecting a suitable PLC input module, power supply, or barrier requires knowledge about Intrinsic Safety and the application. It is the responsibility of the installer to ensure that the intrinsically safe installation complies with both the apparatus approval requirements and the relevant national code of practice.

2. Non-Sparking wiring

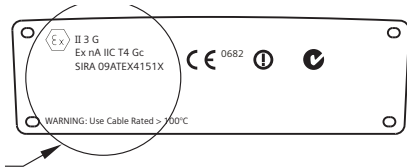
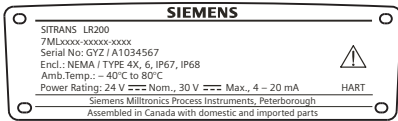

The ATEX certificate listed on the nameplate can be downloaded from the product page of our website at: www.siemens.com/LR200. Go to: **Support > Approvals / Certificates**.

- For power demands see *Curve 1: General Purpose, Intrinsically Safe, Non-Sparking, Non-incendive* on page 20.
- For wiring requirements follow local regulations.
- Refer to *Instructions specific to hazardous area installations* on page 11 and the ATEX certificate listed above.

3. Non-incendive wiring (FM US only)

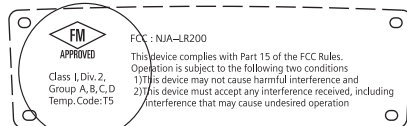
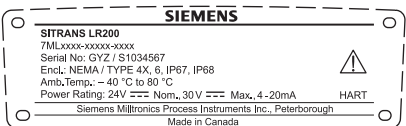

FM Class 1, Div 2 connection drawing number **23650537** can be downloaded from the product page of our website at: www.siemens.com/LR200. Go to **Support > Installation Drawings > Level Measurement > Continuous - Radar**.

- For power demands, see *Curve 1: General Purpose, Intrinsically Safe, Non-Sparking, Non-incendive* on page 20.

4. Flameproof wiring

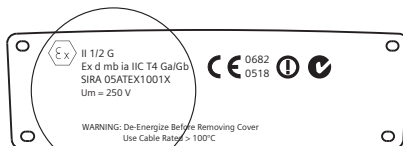
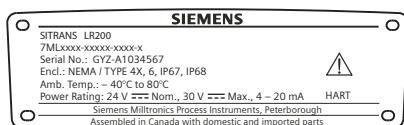

The ATEX certificate can be downloaded from the product page of our website at: www.siemens.com/LR200.

Go to: **Support > Approvals / Certificates.**

- For power demands see *Curve 2: Flameproof, Increased Safety, Explosion-proof* on page 20.
- For wiring requirements follow local regulations.
- See also *Instructions specific to hazardous area installations* on page 11 and the ATEX certificate listed above.

5. Increased safety wiring

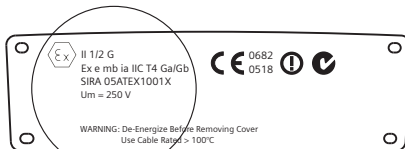
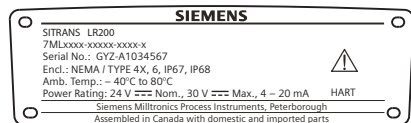

Go to: **Support > Approvals / Certificates.**

- For power demands see *Curve 2: Flameproof, Increased Safety, Explosion-proof* on page 20.
- For wiring requirements follow local regulations.
- See also *Instructions specific to hazardous area installations* on page 11 and the ATEX certificate listed above.

6. Explosion-proof wiring (FM/CSA US/Canada only)

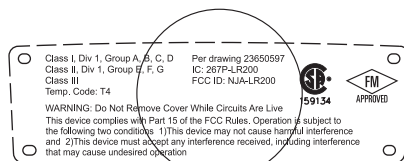
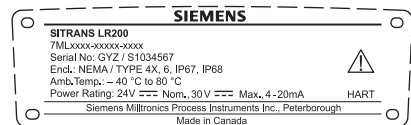

FM/CSA Explosion Proof connection drawing number

23650597 can be downloaded from the product page of our website at:

www.siemens.com/LR200. Go to **Support > Installation Drawings > Level Measurement > Continuous - Radar.**

- For power demands see *Curve 2: Flameproof, Increased Safety, Explosion-proof* on page 20.
- For wiring requirements (North America only) see the connection drawing listed above, which can be downloaded from the product page of our website at: www.siemens.com/LR200.

Instructions specific to hazardous area installations (Reference European ATEX Directive 94/9/EC, Annex II, 1/0/6)

The following instructions apply to equipment covered by certificate numbers SIRA 06ATEX2378X, SIRA 05ATEX1001X, and SIRA 09ATEX4151X:

- 1) For use and assembly, refer to the main instructions.
- 2) The equipment is certified for use as Category 1G equipment per SIRA 06ATEX2378X, Category 1/2 equipment per SIRA 05ATEX1001X, and Category 3G equipment per SIRA 09ATEX4151X.
- 3) The equipment may be used with flammable gases and vapors with apparatus group IIC, IIB, and IIA, and temperature classes T1, T2, T3, and T4.
- 4) The equipment is certified for use in an ambient temperature range of $-40\text{ }^{\circ}\text{C}$ to $+80\text{ }^{\circ}\text{C}$.
- 5) The equipment has not been assessed as a safety related device (as referred to by Directive 94/9/EC Annex II, clause 1.5).
- 6) Installation and inspection of this equipment shall be carried out by suitably trained personnel in accordance with the applicable code of practice (EN 60079-14 and EN 60079-17 in Europe).
- 7) The equipment is non-repairable.
- 8) The certificate numbers have an 'X' suffix, which indicates that special conditions for safe use apply. Those installing or inspecting this equipment must have access to the certificates.
- 9) If the equipment is likely to come into contact with aggressive substances, then it is the responsibility of the user to take suitable precautions that prevent it from being adversely affected, thus ensuring that the type of protection is not compromised.

Aggressive substances: for example, acidic liquids or gases that may attack metals, or solvents that may affect polymeric materials.

Suitable precautions: for example, establishing from the material's data sheet that it is resistant to specific chemicals.

Programming SITRANS LR200

- See *Quick Start Wizard via the handheld programmer* on page 15.
- See *Quick Start Wizard via SIMATIC PDM* on page 18.

Activating SITRANS LR200

Power up the device. SITRANS LR200 automatically starts up in Measurement mode. (To change the language displayed see *Selecting a listed option* on page 14.)

The LCD Display

Measurement mode (normal operation)

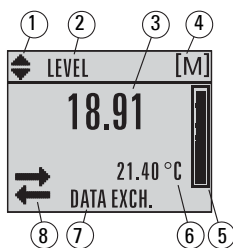

1 – toggle indicator for linear units or %

2 – selected operation: level, space, distance, or volume

3 – measured value (level or volume, space, or distance)

4 – units

5 – bar graph indicates level

6 – secondary region indicates on request¹⁾ electronics temperature, echo confidence, loop current, or distance

7 – text area displays status messages

8 – device status indicator (for details please see the full manual)

¹⁾ In response to a key press request: see *Programming via the handheld programmer* on page 13.

Fault present indicators



S: 0 LOE

When a fault is present the fault code and an error message are displayed in the text area (7), and a service-required icon appears in the device status location (8)

Navigation view

- A visible menu bar indicates the menu list is too long to display all items.
- A band halfway down the menu bar indicates the current item is halfway down the list.
- The depth and relative position of the item band on the menu bar indicates the length of the menu list, and approximate position of the current item in the list.
- A deeper band indicates fewer items.

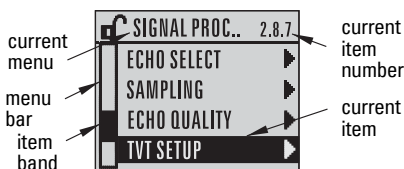

Parameter view

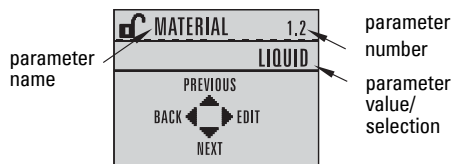

Edit view

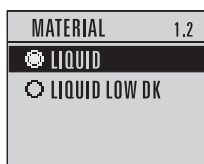

Handheld Programmer (Part No. 7ML1930-1BK)

Ordered separately.

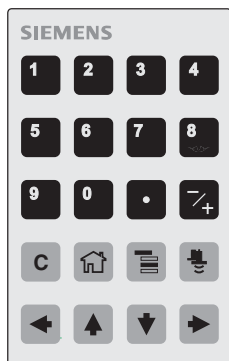

Key	Function in Measurement mode
5	Updates the loop current ¹⁾ .
6	Updates internal enclosure temperature reading ¹⁾ .
8	Updates echo confidence value ¹⁾ .
	Updates distance measurement ¹⁾ .
	Mode opens PROGRAM mode ²⁾ .
	RIGHT arrow opens PROGRAM mode ³⁾ .
 	UP or DOWN arrow toggles between linear units and %

¹⁾ New value is displayed in LCD secondary region.

²⁾ Opens the menu level last displayed in this power cycle, unless power has been cycled since exiting PROGRAM mode or more than 10 minutes have elapsed since PROGRAM mode was used. Then top level menu will be displayed.

³⁾ Opens the top level menu

Programming via the handheld programmer

Notes:

- Press **Mode**  to toggle between Measurement and Program Mode.
- While the device is in PROGRAM mode the output remains fixed and does not respond to changes in the device.
- SITRANS LR200 automatically returns to Measurement mode after a period of inactivity in PROGRAM mode (between 15 seconds and 10 minutes, depending on the menu level).

Parameter menus

Parameters are arranged in a 5-level menu structure.

For the complete list of parameters with instructions, see the full manual.

1. QUICK START

2. SETUP



2.1. DEVICE

2.7. LINEARIZATION

2.7.1. VOLUME

2.7.1.1. VESSEL SHAPE



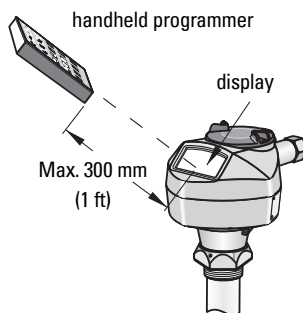

1. Enter PROGRAM mode

- Point the programmer at the display (from a maximum distance of 300 mm [1 ft.]).
- **RIGHT arrow**  activates PROGRAM mode and opens menu level 1.
- **Mode**  opens the menu level last displayed in PROGRAM mode within the last 10 minutes, or menu level 1 if power has been cycled since then.





2. Navigating: key functions in Navigation mode

Note: For Quick Access to parameters via the handheld programmer, press **Home** , then enter the menu number, for example: **2.7.1** (Volume).

Key	Name	Menu level	Function in Navigation Mode
	UP or DOWN arrow	menu or parameter	Scroll to previous or next menu or parameter.
	RIGHT arrow	menu	Go to first parameter in the selected menu, or open next menu.
		parameter	Open Edit mode.
	LEFT arrow	menu or parameter	Open parent menu.
	Mode	menu or parameter	Change to MEASUREMENT mode.
	Home	menu or parameter	Open top level menu: menu 1.



3. Editing in PROGRAM mode

Selecting a listed option

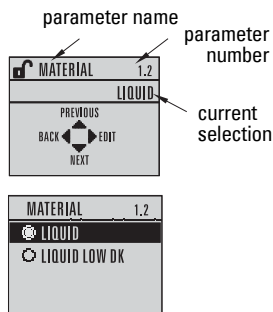
- Navigate to the desired parameter.
- Press **RIGHT arrow**  to open parameter view.
- Press **RIGHT arrow**  again to open **Edit** mode. The current selection is highlighted. Scroll to a new selection.
- Press **RIGHT arrow**  to accept it
The LCD returns to parameter view and displays the new selection.







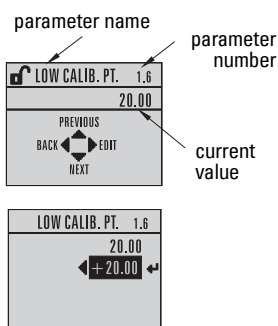



Changing a numeric value

- Navigate to the desired parameter.
- Press **RIGHT arrow**  again to open **Edit** mode. The current value is highlighted.
- Key in a new value.
- Press **RIGHT arrow**  to accept it. The LCD returns to parameter view and displays the new selection.









Key functions in Edit mode

Key	Name	Function in Edit Mode	
	UP or DOWN arrow	Selecting options	Scrolls to item.
		Numeric editing	- Increments or decrements digits - Toggles plus and minus sign
	RIGHT arrow	Selecting options	- Accepts the data (writes the parameter) - Changes from Edit to Navigation mode
		Numeric editing	- Moves cursor one space to the right - or with cursor on Enter sign, accepts the data and changes from Edit to Navigation mode
	LEFT arrow	Selecting options	Cancels Edit mode without changing the parameter
		Numeric editing	- Moves cursor to plus/minus sign if this is the first key pressed - or moves cursor one space to the left.

Key	Name	Function in Edit Mode (continued)	
	Clear	Numeric editing	Erases the display.
	Decimal point	Numeric editing	Enters a decimal point.
	Plus or minus sign	Numeric editing	Changes the sign of the entered value.
 	to Numeral	Numeric editing	Enters the corresponding character.

Quick Start Wizard via the handheld programmer

1. Quick Start

- Point the programmer at the display from a maximum distance of 300 mm (1 ft), then press **RIGHT arrow**  to activate PROGRAM mode and open menu level 1.
- Press **RIGHT arrow**  twice to navigate to menu item 1.1 and open parameter view.
- Press **RIGHT arrow**  to open **Edit** mode or **DOWN arrow**  to accept default values and move directly to the next item.
- To change a setting, scroll to the desired item or key in a new value.
- After modifying a value, press **RIGHT arrow**  to accept it and press **DOWN arrow**  to move to the next item.
- Quick Start settings take effect only after you select **Yes to Apply changes** in step 1.8.

1.1. Language

Selects the language to be used on the LCD and takes effect immediately.

Options	ENGLISH, DEUTSCH, FRANCAIS, ESPANOL
----------------	-------------------------------------

1.2. Material

Options	LIQUID
	LIQUID LOW DK (low dielectric liquid)

1.3. Response Rate

Sets the reaction speed of the device to measurement changes in the target range.

Response Rate	Fill Rate/Empty Rate
SLOW	0.1 m/min (0.32 ft/min)
MED	1.0 m/min (3.28 ft/min)
FAST	10.0 m/min (32.8 ft/min)

Use a setting just faster than the maximum filling or emptying rate (whichever is greater).

1.4. Units

Sensor measurement units.

Options	M, CM, MM, FT, IN
----------------	-------------------

1.5. Operating Mode

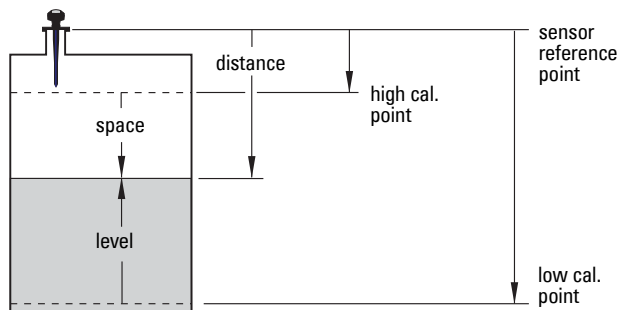

Operation	Description	Reference point
NO SERVICE	Measurement and associated loop current are not updated, and the device defaults to Fail-safe mode ^{a)} .	
LEVEL	Distance to material surface	Low Calibration Point
SPACE	Distance to material surface	High Calibration Point
DISTANCE	Distance to material surface	Sensor reference point

^{a)} For more details on Fail-safe Mode refer to the full manual.

1.6. Low Calibration Point

Distance from sensor reference point to Low Calibration Point: usually process empty level.

Values	Range: 0.00 to 20.00 m
---------------	------------------------

1.7. High Calibration Point

Distance from sensor reference point to High Calibration Point: usually process full level.

Values	Range: 0.00 to 20.00 m
---------------	------------------------

1.8. Apply? (Apply changes)

*In order to save the Quick Start settings it is necessary to select **Yes** to apply changes.*

Options	YES, NO, DONE (Display shows DONE when Quick Start is successfully completed.)
----------------	---

Press **Mode**  to return to Measurement mode. SITRANS LR200 is now ready to operate.

SITRANS LR200 Communications: HART

- You will need the full manual to acquire the list of applicable parameters.
- We recommend that you use SIMATIC Process Device Manager (PDM) to program your device.
- Application Guides for setting up HART devices with SIMATIC PDM can be downloaded from the product page of our website at: www.siemens.com/LR200 under **Support**.

SIMATIC PDM

SIMATIC PDM is a software package used to commission and maintain SITRANS LR200 and other process devices. Please consult the operating instructions or online help for details on using SIMATIC PDM. (You can find more information at: www.siemens.com/simatic-pdm.)

Deactivate Buffers

This aligns SIMATIC PDM with the HART modem for Windows 2000® and Windows XP®¹⁾ operating Systems.

Notes:

- SIMATIC PDM operates only in the Windows XP Professional version, not in the Home version.
- You need administrative rights on your operating system to deactivate buffers.

- 1) Click **Start/Settings/Control Panel** to begin configuration.
- 2) Double click **System**, select the **Hardware** tab, and click the **Device Manager** button.
- 3) Open **Ports** folder and double click the COM Port used by the system to open the **Communications Port Properties** window.
- 4) Select the **Port Settings** tab and double click the **Advanced** button.
- 5) If the **Use FIFO buffers** radio box is selected, click to deselect.

Click **OK** to close out. Close all screens and then reboot.

Update Electronic Device Description (EDD)

Notes:

- SIMATIC PDM Rev. 5.2 SP1 is supported only for basic configuration and troubleshooting.
- For advanced features such as the Quick Start wizard, Rev. 6.0 SP4 or higher is required.
- The EDD is located in Device Catalog, under **Sensors/Level/Echo/Siemens Milltronics/SITRANS LR200**.
- Check the product page of our website at: www.siemens.com/LR200 to make sure you have the latest version of SIMATIC PDM, the most recent Service Pack (SP) and the most recent hot fix (HF). Go to **Support > Software Downloads**.

To install a new EDD:

- 1) Download the EDD from the product page of our website at: www.siemens.com/LR200 and save the files to your computer.
- 2) Extract the zipped file to an easily accessed location.
- 3) Launch **SIMATIC PDM – Manage Device Catalog**, browse to the unzipped EDD file and select it.

¹⁾ Windows® is a registered trademark of the Microsoft Corporation

Configuring a new device

Note: Clicking on **Cancel** during an upload from device to SIMATIC PDM will result in some parameters being updated.

- 1) Check that you have the most recent EDD, and if necessary update it (see *Update Electronic Device Description (EDD)* on page 17.
- 2) Launch SIMATIC PDM and create a new project for LR200.
- 3) Open the menu **Device – Master Reset** and click on **OK** to perform a reset to Factory Defaults.
- 4) After the reset is complete upload parameters to the PC/PG.
- 5) Configure the device via the Quick Start wizard (see below).

Quick Start Wizard via SIMATIC PDM

Notes:

- The Quick Start wizard settings are inter-related and changes apply only after you click on **FINISH AND DOWNLOAD** at the end of step 5 to save settings offline and transfer them to the device.
- Click on **BACK** to return and revise a setting or **Cancel** to exit the Quick Start.

Launch SIMATIC PDM, open the menu **Device – Wizard - Quick Start**, and follow steps 1 to 5.

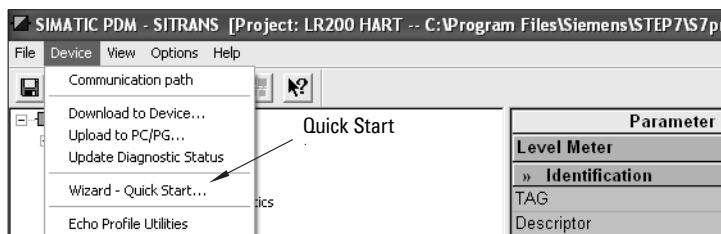

Operating via FDT (Field Device Tool)

FDT is a standard used in several software packages designed to commission and maintain field devices. Two commercially available FDTs are PACTware and Fieldcare.

To configure a field device via FDT you need the DTM (Device Type Manager) for the device. Siemens instruments use SITRANS DTM and an instrument EDD written for SITRANS DTM.

- 1) First install SITRANS DTM on your system. You can download it from: <http://support.automation.siemens.com>. Click on **Product Support**, and navigate to **Product Information/Automation Technology/Sensor systems/Process Instrumentation/Software & Communications**.
- 2) Install the SITRANS LR200 HART EDD for SITRANS DTM. You can download it from the product page of our website at: www.siemens.com/LR200. Go to **Support > Software Downloads**.

Configuring a new device via FDT

An Application Guide can be downloaded from the product page of our website under **Support**.

Operating via AMS Device Manager

AMS Device Manager is a software package designed to commission and maintain field devices. Please consult the operating instructions or online help for details on using AMS Device Manager. You can find more information at: <http://www.emersonprocess.com/AMS/>.

Electronic Device Description (EDD)

SITRANS LR200 requires the EDD for AMS Device Manager version 9.0.

Configuring a new device via AMS Device Manager

- 1) Check the product page of our website at: www.siemens.com/LR200 to make sure you have the most recent EDD. Go to **Support > Software Downloads** and if necessary download it. Save the files to your computer, and extract the zipped file to an easily accessed location.
- 2) Launch **AMS Device Manager– Add Device Type**, browse to the unzipped EDD file and select it.

Launch AMS Device Manager. An Application Guide for setting up HART devices with AMS Device Manager can be downloaded from the product page of our website under **Support**.

Maintenance

SITRANS LR200 requires no maintenance or cleaning under normal operating conditions. If cleaning becomes necessary under severe operating conditions:

- 1) Note the antenna material and the process medium, and select a cleaning solution that will not react adversely with either.
- 2) Remove the device from service and wipe the antenna clean using a cloth and suitable cleaning solution.

Unit Repair and Excluded Liability

For detailed information, please see the inside back cover.

Maximum Process Temperature Chart



WARNING: Internal temperature must not exceed 80 °C (176 °F).

Notes:

- The chart is for guidance only and does not represent every possible process connection arrangement. (It will NOT apply if SITRANS LR200 is mounted directly on a metallic vessel surface.)
- The chart does not take into consideration heating from direct sunshine exposure.
- Parameter 3.2.1 Current Internal Temperature monitors the internal temperature.

Flange Adapter versions of SITRANS LR200

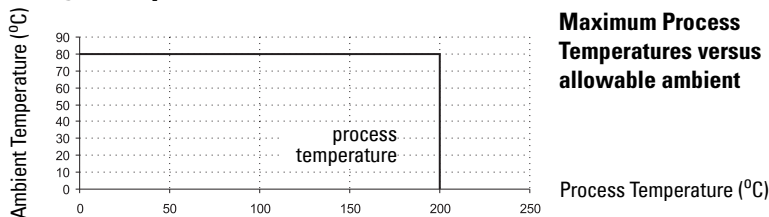

Startup Behavior

- The device draws less than 3.6 mA at startup.
- Time to first measurement is less than 50 seconds

Loop power

Curve 1: General Purpose, Intrinsically Safe, Non-Sparking, Non-incendive

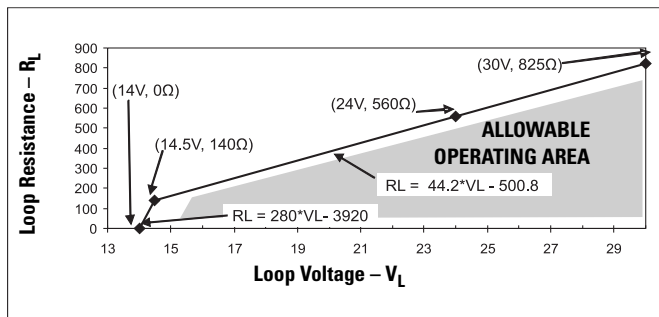

Curve 2: Flameproof, Increased Safety, Explosion-proof

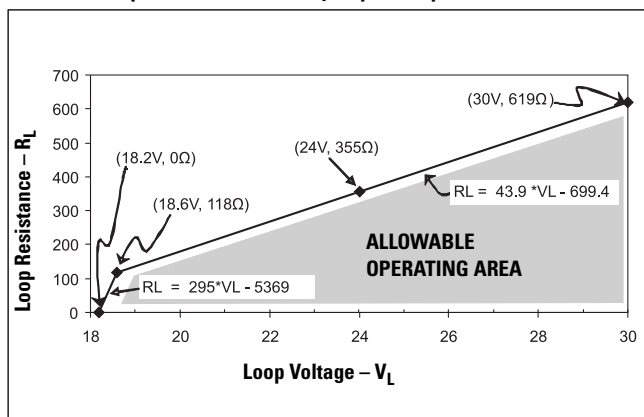

For more information

www.siemens.com/level

www.siemens.com/weighing

Siemens Canada Limited
1954 Technology Drive
P.O. Box 4225
Peterborough, ON
Canada K9J 7B1

Subject to change without prior notice
A5E31993614 Rev. AC
© Siemens AG 2016



Printed in Canada

www.siemens.com/processautomation