

QUESTEMP[®]
HEAT STRESS MONITORS
MODELS 34 AND 36
USER MANUAL



Table of Contents

Introduction	1	Approved 9-Volt Batteries	21
QUESTemp® Models	1	NiMH Battery Pack	21
Getting Started	2	Appendix A: Specifications	22
Up and Running overview	2	Measurements.....	22
Keypad Operation.....	3	Data Logging.....	22
Turning on/off and basic operation	4	Languages.....	22
Placement for Monitoring/Testing.....	4	Housing	22
Sensors	5	Size	22
Natural Wet Bulb Thermometer.....	5	Weight	22
Globe Thermometer	5	Sensor Types	22
Dry Bulb Thermometer	6	Accuracy.....	22
Relative Humidity Sensor	6	Operating Temperature Range	22
Tri-sensor Calculation and Remote Cable	7	Remote Sensor Bars	23
Tri-sensor weighted average	7	Power Options.....	23
Measurements	8	Battery Life	23
Wet Bulb Globe Temperature.....	8	Charge Time (NiMH Battery Pack).....	23
Stay Times/Rest Times (QT®36 only)	8	Air Probe Accessory (QUESTemp® 36 model only).....	23
Heat Index/Humidex	9	Product markings and batteries	23
Air Flow.....	9	Appendix B: Heat Exposure Tables	25
Thermal Comfort (QUESTemp® 36 model only).....	9	ACGIH	25
Operating QUESTemp® 34 & 36	10	ACGIH Clothing Corrections	26
View	10	United States Navy.....	26
Setup	10	Electrical power research institute (EPRI).....	28
Print	11	Appendix C: Accessories	29
Reset	11	Air Probe Accessories	29
Run	12	Appendix D: Detection Management	
Displayed Items	13	Software DMS	30
Stay Time.....	14	DMS Quick overview	30
Data Logging	15	Downloading your sessions in DMS.....	30
Printing	16	Viewing/Analyzing and Quick Reporting in DMS	32
Serial.....	16	Reporting and Printing.....	34
Parallel.....	16	Contact/Service information	35
Air Flow functionality	18	Technical Support Contacts	35
Operating sequence	19	Service Contact Information.....	35
Data Logging Air Flow	19	Returning for Service.....	36
Batteries for Air Probe	19	Calibration	36
Operational Check	20	Warranty	37
Power options	20		
9-Volt Alkaline Battery Replacement	20		

List of Figures and Tables

1-1: QUESTemp° 36 model.....	1	1-19: Sample printout (page 1)	16
1-2: Keypad explained.....	3	1-20: Sample printout (page 2).....	17
1-3: Main menu of the QUESTemp° 34 & 36	4	1-21: Air flow configuration	18
1-4: Filling wet bulb reservoir	5	1-22: 9-volt battery.....	20
1-5: Ports identified	7	1-23: NiMH rechargeable battery	21
1-6: Viewing measured data.....	10	1-24: Communicating to DMS	30
1-7: Setup selected in main menu.....	10	1-25: Downloading with the QT ⁰ 34/36	31
1-8: Run mode indicator	12	1-26: Data Finder page (Analyze/Quick Report options)	32
1-9: Wet and Dry screen	13	1-27: Data layout page (displays your data in charts and graphs).....	33
1-10: Globe screen.....	13	1-28: Reporting and printing	34
1-11: WBGTi & WBGT _o screen	13		
1-12: RH and H.I/HU screen	13	Tables	
1-13: Air Flow screen	14	1-1: Example of a Memory table.....	15
1-14: Stay times (ACGIH)	14		
1-15: Time & Date screen	14		
1-16: Battery & Memory screen	14		
1-17: Navy Stay time screen.....	15		
1-18: EPRI Stay time screen.....	15		

Introduction

The QUESTemp^o 34/36 models are portable heat stress monitors that are designed to be rugged, easy-to use instruments to quickly and accurately assess the potential for individual heat stress based on environmental conditions.

QUESTemp^o Models

The QUESTemp^o 34 and QUESTemp^o 36 models measure and calculate the dry bulb temperature, wet bulb temperature, globe temperature, WBGT indoor index, WBGT outdoor index, relative humidity, and Heat Index or Humidex. These models support RS-232 communications and works with the optional software analysis program, TSI Detection Management Software (DMS).

With the QUESTemp^o 36, you have the capability to display stay times in order to manage work/rest regimens. Guidance is based on the screening criteria for heat stress as defined in the ACGIH TLV Handbook, U.S. Navy PHEL charts, and EPRI Action Limits. (See Appendix B for detailed chart information.)

An additional feature with the QUESTemp^o 36 is an optional detachable air-probe for measuring air velocity (wind speed) to determine appropriate levels of indoor thermal comfort monitoring.



Figure 1-1: QUESTemp^o 36 Heat Stress Monitor

Getting Started

Up and Running Overview

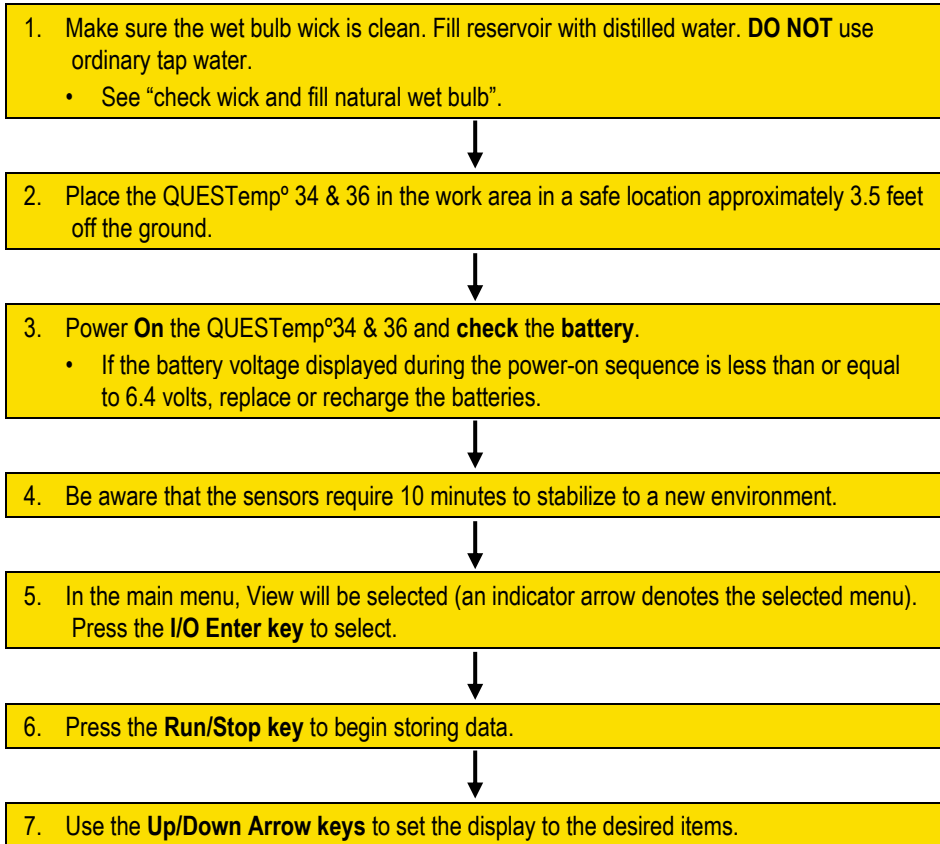

Keypad Operation

The unit operates using a keypad with four keys. The **I/O Enter key** responds when the key is released while all other keys respond when the key is pressed.

Keys	Explanation
I/O Enter key	The unit turns on with a single key press. The unit turns off by holding the key down while a countdown of 3-2-1 occurs in the lower right corner of the display. This key is also used to select a mode (such as Setup or View) or enter setup changes. Pressing and releasing the key while viewing temperatures causes the display to view the next available sensor bar (indicated in the upper right corner of the display).
Up Arrow key	Changes items appearing in the display. Scrolls up.
Down Arrow key	Changes items appearing in the display. Scrolls down.
Run/Stop key	From the menu or view modes, pressing this key starts or stops the run mode. Pressing this key will exit the setup, print or reset modes.
Escaping or moving back one screen	If you are in the setup, print, reset, or calibration screens, you can press Run/Stop key to escape or move back one screen.

NOTE: The QUESTemp[®] 34 & 36 models have the same keypad. Figure 1-2 is an example of the QUESTemp[®] 36 model with the optional air-probe attachment.



Figure 1-2: Keypad explained

Turning On/Off and Basic Operation

To quickly get you started with the QUESTemp^o 34 & 36 model, the following section explains how to turn on the instrument, run, and stop your session.

1. Press the **I/O Enter** key to **turn on**. Following the model and revision information displayed on the screen, the main menu will appear.

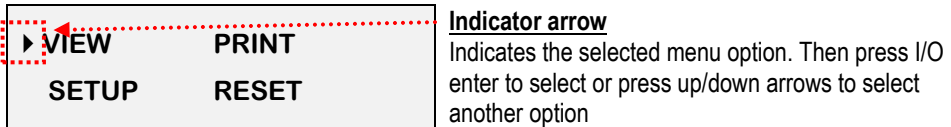

Figure 1-3: Main menu of the QUESTemp^o 34 & 36

2. Press the **I/O Enter** key (when view is selected) to access the measurement screens.
 - The Wet and Dry measurements screen will display. (See Figure 1-6 for screen example.)
3. To view different measurements, press the **Up** or **Down arrow** key to toggle through the views.
 - NOTE:** There are five user-selectable languages. If you see the fields such as Wet, Dry, WBGTi, and WBGTo this indicates the measurements are displaying in English.
 - To display an alternative language, select **Setup** from the main menu. Press the **Down** arrow repeatedly until “English” (or the appropriate language) appears. Then repeatedly press the **I/O enter** key to toggle through the languages. Once selected, all menus and measurement screens will change to the selected language. To return to the main menu, press the **Run/Stop** key.
4. To return to the **main menu**, press and hold the **I/O Enter** key (3, 2, 1 countdown will appear) and the main menu will display.
 - To select an option on the main menu, press the **up or down arrow** until an arrow appears directly in front of the appropriate menu selection and then press **I/O enter** key.
5. To **power off**, press and hold the **I/O enter** key from the main menu.

Placement for Monitoring/Testing

The QUESTemp^o 34 & 36 model should be placed at a height of 3.5 feet (1.1 m) for standing individuals or 2 feet (.6 m) for seated individuals. Tripod mounting is recommended to get the unit away from anything that might block radiant heat or air flow. A 1/4" x 20 threaded bushing on the bottom of the instrument allows mounting to a standard photographic tripod. **DO NOT** stand close to the unit during sampling.

- NOTE:** Before measuring, allow 10 minutes for the sensors readings to stabilize.

Sensors

Natural Wet Bulb Thermometer

The natural wet bulb thermometer gives an indication of the effects of humidity on an individual. Relative humidity and wind speed are taken into account by measuring the amount of evaporative cooling taking place at a thermometer covered with a moistened wick.

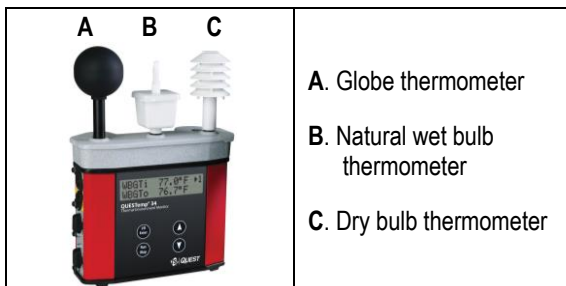

Check Wick and Fill Natural Wet Bulb

The QUESTemp[®] Heat Stress Monitor uses a cotton wick immersed into a reservoir containing distilled water. **DO NOT** use ordinary tap water, as the contaminants that are left behind after evaporation will shorten the life of the wick and cause high readings. If the wick is discolored it should be replaced. To **replace the wick**, slide the old wick off the top of the sensor. Place a new wick over the sensor, making sure that the bottom of the wick is down in the reservoir.

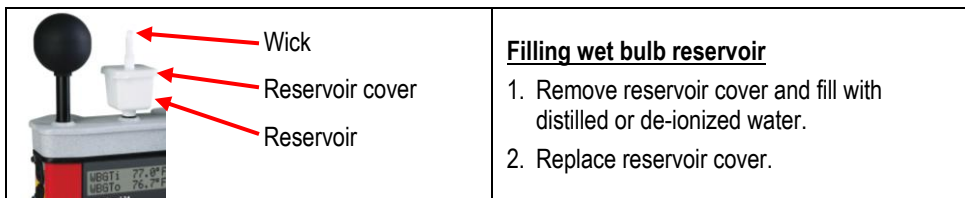

Figure 1-4: Filling wet bulb reservoir

Globe Thermometer

The globe thermometer (left position) gives an indication of the radiant heat exposure on an individual due to either direct sunlight or hot objects in the environment. This is accomplished by placing a temperature sensor inside a blackened copper sphere and measuring the temperature rise. The WBGT index is based on the response of a 6 inch diameter globe. The QUESTemp[®] uses a 2-inch diameter globe for a faster response time. The temperature of the 2-inch globe is correlated to match that of a 6 inch globe.

Dry Bulb Thermometer

The dry bulb thermometer (right position) measures the ambient air temperature. This measurement is used in the outdoor WBGT calculation when a high solar radiant heat load may be present. The series of white plates surrounding the sensor shield it from radiant heat.

Relative Humidity Sensor

A relative humidity sensor is located in a compartment inside of the sensor bar housing. Slots in the housing allow air to circulate around the sensor.

Tri-sensor Calculation and Remote Cable

The top sensor bar (sensor 1) may be removed from the instrument and used through a remote cable. Shelter the instrument and remote the sensor bar if the measured environment is expecting heavy rain or if temperatures are above 60°C.

The sensor 2 and sensor 3 jacks on the side of the instrument allow simultaneous monitoring of up to three sensor arrays using connecting cables.

Cable lengths of up to two hundred feet (61 meters) may be used without a decrease in accuracy provided the environment does not contain strong electromagnetic fields. The data from these arrays may be viewed separately or combined into a weighted average WBGT reading per ISO 7243. Change the displayed sensor bar by pressing and releasing the enter key. The upper right corner of the display shows the current sensor bar. 1 refers to the top sensor bar, 2 and 3 are labeled on the side of the unit, W indicates the weighted average which only appears if a WBGT is displayed and all three of the sensor bars are attached.

Tri-sensor Weighted Average

Per the recommendations outlined in ISO 7243:2017, when the temperature in the space surrounding a worker is not uniform, it is necessary to determine the WBGT index at three heights corresponding to the worker's ankles, abdomen and head and perform a weighted average on those values. It is computed using the formula:

$$WBGT_w = (WBGT_{head} + (2 \times WBGT_{abdomen}) + WBGT_{ankles})/4$$

The QUESTemp° 36 always assigns the top sensor bar the double weighting. This calculation is shown if a WBGT display has been selected and if three sensor sets are connected.

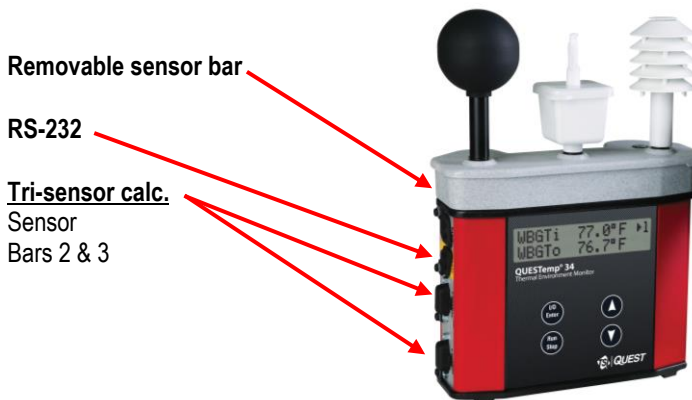

Figure 1-5: Ports identified

Measurements

The QUESTemp° 34 & 36 data logging area heat stress monitor directly senses the four parameters: ambient or dry bulb temperature (DB), natural wet bulb temperature (WB), globe temperature (G), and relative humidity (RH).

The QT° 34/ 36 compute the Wet Bulb Globe Temperature (WBGT), stay times for three possible indices (QT° 36 only), and the Heat Index (HI) or the Canadian Humidex. Using inputs on the side of the instrument, two additional sensor arrays can monitor up to three locations simultaneously.

On the QUESTemp° 36 model, you can measure air flow, in meters per second, by plugging an optional hot wire anemometer sensor into a side jack on the unit.

Using Detection Management Software (DMS), you can determine the thermal comfort indices, Predicted Mean Vote (PMV) and Predicted Percent Dissatisfied (PPD) (with the QUESTemp° 36 model only).

Wet Bulb Globe Temperature

The WBGT is a weighted average of the three temperature sensors, a globe thermometer, a wet bulb thermometer, and a dry-bulb thermometer, using the equations listed below.

WBGT (indoor) = $0.7WB + 0.3G$ (denoted as “WBGTi” on the display)
WBGT (outdoor) = $0.7WB + 0.2G + 0.1DB$ (denoted as “WBGT_o” on the display)

The resulting WBGT values can then be compared to indices of work-rest regimens (stay times) based upon workloads.

Stay Times/Rest Times (QT°36 only)

Stay times represent how long a worker should be able to safely work under heat stress conditions (available on QUESTemp° 36 only). Select one of the three indices for displaying and printing from the unit: ACGIH Stay Times, NAVY PHEL's, or EPRI Action Limits. (For setup, refer to “Setup.” For detailed rest times refer to charts in Appendix B.)

Heat Index/Humidex

The Heat Index is determined using the dry bulb temperature and relative humidity. Based upon charts available from the U.S. National Weather Service, Heat Index represents how an average person feels relative to climate conditions. For a given temperature, the higher the humidity, the higher the heat index.

The Heat Index is defined over a temperature range of 70°F – 120°F (21°C – 49°C) and a relative humidity range of 30% - 99%. Outside of this range, the instrument will show dashes in the display for the Heat Index.

The Humidex, used primarily in Canada, functions similar to the Heat Index concept. The values are slightly different. The Humidex is defined over a temperature range of 70°F – 109°F (21°C – 43°C) and a relative humidity range of 20% – 99%. Outside of this range, the instrument will show dashes in the display for the Humidex.

Air Flow

The QUESTemp^o 36 measures air flow if the Air Probe accessory is used. The Air Probe uses an omni-directional anemometer sensor that measures air flow between 0 and 20 meters per second in 0.1 m/s increments. See “Air Flow Functionality,” for more details.

Thermal Comfort (QUESTemp^o 36 model only)

Thermal comfort readings for indoor environments are a benefit of DMS software and are not displayed or printed from the instrument directly. Readings are derived from the dry bulb, relative humidity, mean radiant temperature, air flow, and user entered parameters of clothing, metabolic rate and external work.

Thermal comfort indices, Predicted Mean Vote (PMV) and Predicted Percent Dissatisfied (PPD), help predict the thermal satisfaction level of a person with their indoor environment. The PMV is a rating scale of +3 to -3 where +3 is much too warm, -3 is much too cool, and 0 is thermally neutral. The PPD reflects what percent of people in a given location would be dissatisfied with their thermal surroundings.

The formulas used by DMS software to derive the PMV and PPD come from the international standard ISO 7730 “Moderate thermal environments - Determination of the PMV and PPD indices and specification of the conditions for thermal comfort.”

Operating QUESTemp° 34 & 36

Use the **Up Arrow** and **Down Arrow** keys to move the marker in the display in front of the desired mode. Pressing the **I/O Enter** key will select the mode.

View

Displays the measured data but does not log it. If more than one set of sensors is plugged into the unit, these can be displayed by pressing and releasing the **I/O ENTER** key. The displayed **sensor set** is shown in the **upper right corner**.



Figure 1-6: Viewing measured data

- NOTE:** To return to the menu, hold down the **I/O ENTER** key while a 3, 2, 1 countdown is shown in the lower right corner of the display. Then the menu screen will appear (see Figure 1-3 for an example).

Setup

The setup screen is used to change the following parameters: temperature units, language, time, date, logging rate (QUESTemp° 36 only), selecting between Heat Index and Humidex, and setting stay time parameters.

➤ To Setup parameters do one of the following:

1. From the main menu, select **Setup** by pressing the **I/O Enter** key.



Figure 1-7: Setup selected in main menu

2. Use the **Arrow keys** to select an item (listed below).
 - **Temperature:** Celsius, Fahrenheit.
 - **Language:** English, Spanish, French, Italian, German.
 - **Time:** 24 hour clock only.
 - **Date:** Day-month-year format.
 - **Log Rate:** 1, 2, 5, 10, 15, 30, 60 minutes.
 - **Heat Index** (United States), **Humidex** (Canada)

- **Flow:** On, Off .
- **Index:** none, ACGIH, Navy, EPRI and select either: WBGTi (indoor), WBGT_o (outdoor) for Index setting.

Index Settings	Explanation
TLV and action limit	These index settings only apply to the ACGIH Index. EPRI and Navy will ignore this setting.
Clothing Correction	Parameters are set from 0 - 9.9°C. This is a clothing correction for the WBGT in degrees Celsius and is applied to the selected WBGT when the work duration is calculated. (It will not affect the WBGT as displayed by the unit.) This value should typically be set to 0.0 for the Navy. (The field is noted as "Clo Corr".)

3. Press the **I/O Enter** key to change a parameter. Time and date require using the **Up/Down Arrows** and **I/O Enter** keys to modify each number.
 - NOTE:** At any time, you can move back one level, by pressing the **Run/Stop** key.
4. Exit Setup by pressing the **Run/Stop** key.

Print

QT°34/36 allows printing to a parallel or serial printer or to a computer. The QUESTemp° 36 will recognize the cable plugged in and configure itself for serial or parallel. If no cable is plugged in, it will default to serial. Press **I/O Enter** key to begin printing. Press **Run/Stop** key to return to the menu.

- NOTE:** If you want to stop the printing, press I/O enter key until you return to the main menu. When the printer has stopped printing, remove the cable from the printer to the instrument.

Reset

Resetting enables you to clear the logged data from memory. Press the **I/O Enter key** to enter the **Reset mode**. Clear the memory by holding down the **I/O Enter key** while the display counts down from three.

Run

The run mode begins a session in memory and logs the data.

1. Begin a session by pressing the **Run/Stop key** from the view mode (or measurement view). An asterisk in the lower right corner indicates the run mode.
 - To toggle through the views, press the up or down arrow.



Figure 1-8: Run mode indicator

2. End the session by pressing the **Run/Stop key** again. (The session will stop recording when the asterisk is no longer displayed.)
 - NOTE:** If the logging memory is full or if there are no sensors plugged into the unit, attempting to enter the Run mode will result in an error message. If the memory capacity is exceeded, the asterisk in the lower right corner of the display will turn into an “F” and the memory remaining screen will show “0.0”.

Displayed Items

For the QUESTemp° 34 & 36 models, the number in the upper right corner indicates which sensor bar's data is displayed.

- “1” indicates the sensor bar placed on (or attached to) the top of the instrument. Sensors 2 and 3 are labeled on the side of the unit as “Sensor 2”, and “Sensor 3”.
- “W” indicates the weighted average which only appears if a WBGT is displayed and all three sensor bars are attached. An asterisk in the lower right corner indicates that the unit is in the run mode and is logging data.

The following measurements can be accessed on the display:

Screen 1: WET (Wet bulb)
 DRY (Dry bulb)

WET	80.5° F	▶ 1
DRY	92.2° F	*

Figure 1-9: Wet and Dry screen

Screen 2: GLOBE

GLOBE	92.4.° F	▶ 1
		*

Figure 1-10: Globe screen

Screen 3: WBGT_i (Indoors)
 WBGT_o (Outdoors)

WBGT_i	84.1 ° F	▶ 1
WBGT_o	107.5 ° F	*

Figure 1-11: WBGT_i & WBGT_o screen

Screen 4: RH (Relative Humidity)
 H.I. or HU
 (Heat Index or Humidex)

RH	66.2 %	▶ 1
H.I.	84.3° F	*

Figure 1-12: RH and H.I./HU screen

Screen 5: Air Flow
(If turned ON via setup
with QUESTemp^o 36 only)

FLOW	0.3m/s	▶ 1
-------------	---------------	------------

Figure 1-13: Air Flow screen

Screen 6: Stay times
(QUESTemp^o 36 only)

L	M	H	VH	▶ 1
60	45	30	15	*

Figure 1-14: Stay times (ACGIH)

Screen 7: Time (24 hour format)
Date (day, month, year)

TIME	11:04:13	▶ 1
DATE	26-JUN-08	*

Figure 1-15: Time & Date screen

Screen 8: BAT (Battery voltage)
MEM (Logging memory
available in days)

BAT	11:04:13	▶ 1
MEM	10.4dy	*

Figure 1-16: Battery & Memory screen

NOTE: A series of dashes appear in the display if one of the following occur:

- The Heat Index or Humidex is outside of its allowable range.
- The temperature is outside of its allowable range.
- A temperature sensor has failed.
- Stay times temperatures are outside of the defined range.

Stay Time

The screen(s) displaying stay time data appear different for each of the possible indices (available with QUESTemp^o 36 model only).

If **ACGIH** is selected, the recommended working minutes per hour are shown for each of the workload categories Light (L), Moderate (M), Heavy (H), and Very Heavy (VH). (See Figure 1-14 above.)

If the **Navy PHELs** are selected, the recommended working hours are shown based on a maximum of eight hours. Three screens are used to display the PHELs two at a time.

NOTE: “8:01” following one of the PHELs indicates greater than eight hours.

PHEL_5	3:10	▶ 1
PHEL_6	2:10	

Figure 1-17: Navy Stay time screen

If **EPRI** is selected, the recommended working hours are shown based on a maximum of four hours. Working hours for Light (L), Moderate (M), and Heavy (H) workload categories are displayed below.

NOTE: “4:01” indicates greater than four hours.

L	M	H	▶ 1
4:01	3:00	1:30	

Light, Medium, and Heavy maximum hours displayed

Figure 1-18: EPRI Stay time screen

Data Logging

Data from each sensor is recorded at the interval set by the logging rate (for QUESTemp^o 34 & 36 models only). Every time **Run/Stop** is pressed, a session is either started or ended in memory. Each session contains a header with time, date, and summary information.

Memory Table: Gives the number of logging DAYS.

Log Rate	1 min	2 min	5 min	10 min	15 min	30 min	60 min
1 sensor	11.2	22.5	56.2	112.4	168.6	337.3	674.5
2 sensors	5.6	11.2	28.1	56.2	84.3	168.6	337.3
3 sensors	3.7	7.5	18.7	37.5	56.2	112.4	224.8

Table 1-1: Example of a Memory table

Printing

The recorded data can be sent to a computer through the serial RS-232 port or to a parallel printer. Serial transmission requires TSI cable #054-715. Parallel transmission requires TSI cable #056-875. With the cable plugged into the RS-232 auxiliary port, select **Print** from the menu and press the **I/O Enter key** to enter the **Print** mode. Begin printing by pressing the **I/O Enter key**. Press the key again to abort printing.

Serial

DMS software is recommended for downloading, storing, and graphing your data. Communications programs such as Windows® HyperTerminal® program may also be used to capture the printout into a file. The baud rate is fixed at 9600.

Parallel

Data can be sent directly to parallel printers that accept direct ASCII text input without special drivers. Make sure the **printer is powered on** and is **online**, ready to accept data, prior to printing.

TSI		Page 1	
HEAT STRESS REPORT			
File Name	_____	Questemp 36 Rev 1.00	
Employee	_____	Serial # TK09090909	
Facility	_____	Session (3)	
Department	_____	Start: 21-FEB-08 11:07:32	
Job	_____	Stop: 21-FEB-08 11:10:15	
Comments/Notes	_____	Printed: 21-FEB-08 11:16:00	

Logging Interval: 1 minutes			
Degrees Fahrenheit			
MAXIMUM LEVELS, Sensor 1			
WBGT IN	69.2	21-FEB-08	11:10:14
WBGT OUT	68.3	21-FEB-08	11:10:08
WET BULB	59.7	21-FEB-08	11:10:08
DRY BULB	82.7	21-FEB-08	11:09:56
GLOBE	91.4	21-FEB-08	11:10:12
HEAT INDEX	0	00-XXX-00	00:00:00
REL HUMIDITY	14%	21-FEB-08	11:07:32
FLOW (m/s)	0.6	21-FEB-08	11:09:08
MAXIMUM LEVELS, Sensor 2			
WBGT IN	81.2	21-FEB-08	11:10:06
WBGT OUT	80.5	21-FEB-08	11:10:11
WET BULB	70.5	21-FEB-08	11:10:11
DRY BULB	99.2	21-FEB-08	11:09:07

Figure 1-19: Sample printout (page 1)

Session: 3													Page 2
Sensor: 1													
Degrees Fahrenheit													
Stay Times: ACGIH, Acclimated, WBGTi, clo correction = 1.0 C													
TIME	WBGTi	WBGT _o	WET	DRY	GLOBE	RH	HI	FLOW	L	M	H	VH	
-----	-----	-----	-----	-----	-----	-----	-----	-----	-----	-----	-----	-----	-----
11:08	68.7	67.9	59.4	82.4	90.7	13	0	0.5	60	60	60	60	
11:09	69.0	68.1	59.5	82.6	91.3	12	0	0.5	60	60	60	60	
Session: 3													Page 3
Sensor: 2													
Degrees Fahrenheit													
Stay Times: ACGIH, Acclimated, WBGTi, clo correction = 1.0 C													
TIME	WBGTi	WBGT _o	WET	DRY	GLOBE	RH	HI	L	M	H	VH		
-----	-----	-----	-----	-----	-----	-----	-----	-----	-----	-----	-----	-----	-----
11:08	79.9	79.3	69.4	98.9	104.5	15	0	60	45	30	15		
11:09	80.8	80.2	70.3	99.2	105.6	15	0	60	45	30	15		
Session: 3													Page 4
Sensor: 3													
Degrees Fahrenheit													
Stay Times: ACGIH, Acclimated, WBGTi, clo correction = 1.0 C													
TIME	WBGTi	WBGT _o	WET	DRY	GLOBE	RH	HI	L	M	H	VH		
-----	-----	-----	-----	-----	-----	-----	-----	-----	-----	-----	-----	-----	-----
11:08	68.6	68.1	58.3	88.0	92.7	11	0	60	60	60	60		
11:09	68.8	68.4	58.6	88.3	92.9	11	0	60	60	60	60		
Session: 3													Page 5
Sensor: WBGT(W-AVG) = .50*WBGT(1) + .25*WBGT(2) + .25*WBGT(3)													
Degrees Fahrenheit													
Stay Times: ACGIH, Acclimated, WBGTi, clo correction = 1.0 C													
TIME	WBGTi	WBGT _o	W-AVG	W-AVG	L	M	H	VH					
-----	-----	-----	-----	-----	-----	-----	-----	-----	-----	-----	-----	-----	-----
11:08	71.5	70.8	60	60	60	60	60	60					
11:09	71.8	71.1	60	60	60	60	45						

Figure 1-20: Sample printout (page 2)

Air Flow functionality

(Available using TSI's Air Probe on QUESTemp° 36 model.)

Air flow is measured in meters per second over a range of 0 to 20 m/s in 0.1 m/s increments. The sensor should be placed or held perpendicular in the air stream. Unlike many anemometers, the omni-directional sensor does not require rotating to find the maximum reading. Be careful not to block the air flow with your body during measurements. The sensor's measuring tip is fragile; be cautious if measuring in ducts.

The Air Probe may be either hand held or mounted behind the QUESTemp° 36 using the mounting bracket hooked to the sensor bar beneath the center bulb sensor. (See Figure 1-21 below.)

A green lamp indicator in the Air Probe indicates that it is turned on and the battery is good. If the green indicator turns off while the switch is in the **On** position, replace or recharge the battery.

- To connect, follow steps 1-3 below.

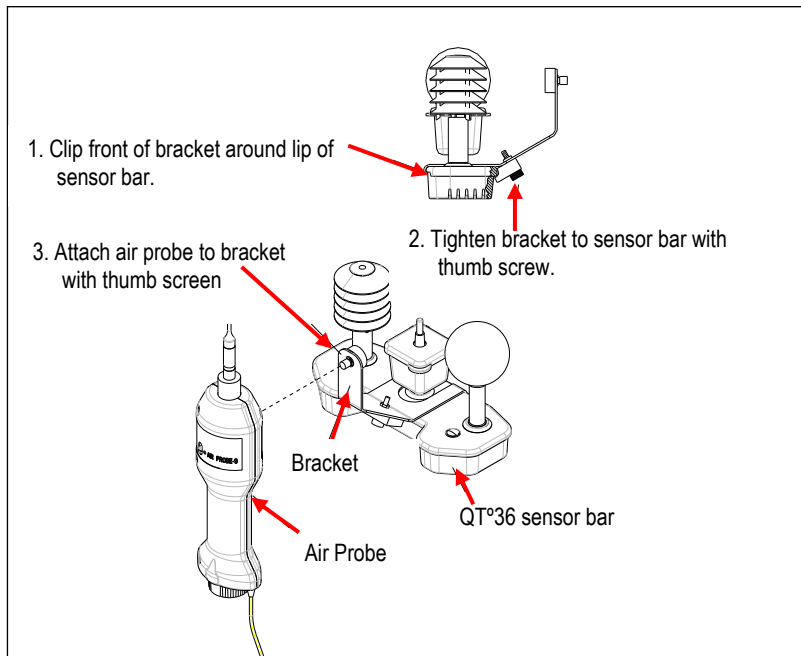

Figure 1-21: Air flow configuration

Operating Sequence

1. Turn **Flow On** in the setup menu of the QUESTemp° 36 Heat Stress Monitor.
2. Plug the Air Probe into the port labeled **Flow** on the side of the QUESTemp° 36.
3. Turn on the Air Probe **ON** and make sure the green lamp is lit.
 - In the View or Run modes, air flow is displayed on the fifth screen.

Data Logging Air Flow

To data log air flow in the QUESTemp° 36, the following two conditions must be met.

1. First, turn **Flow On** in the setup menu.
2. Second, make sure that a temperature sensor bar is connected to the Sensor 1 location (top) of the QUESTemp° 36. Flow prints out with the Sensor 1 data therefore air flow data will only be reported if a sensor bar is plugged in. Air flow is recorded during the run mode at the interval the QUESTemp° 36 is setup for.

Batteries for Air Probe

The Air Probe uses a single NiMH Black&Decker® VersaPak™ Gold battery. Typical operating time of the battery is between 6 and 8 hours.

To change the battery, push in and twist, counterclockwise, the cap on the bottom of the Air Probe. Pull out the battery. Insert a fully charged battery and replace the cap.

To recharge the batteries, set the battery into the VersaPack™ charger. The supplied charger accepts one or two batteries. A full charge takes 9 hours. An indicator light shows that the battery is properly charging and it will remain on as long as the battery is in the charger. Continuous charging is not a safety concern.

Operational Check

A verification module, TSI model 053-923, may be used to check the operation of the QUESTemp° Heat Stress Monitor. Remove the top sensor bar and plug the verification module into the top of the unit. With the QUESTemp° set to read in degrees Celsius, verify that the displayed readings match those printed on the module within $\pm 0.5^{\circ}\text{C}$.

If the readings are not within the $\pm 0.5^{\circ}\text{C}$ tolerance, then have the unit serviced and calibrated.

Power options

There are three options for powering the QUESTemp° 36: a 9-volt alkaline battery, a NiMH (Nickel Metal Hydride) rechargeable 6-cell battery pack, and an AC adapter. A door on the back of the unit allows the user access to the 9-volt battery. The rechargeable battery pack is located inside of the unit. If the rechargeable battery pack ever needs to be replaced, it can be accessed by removing the screws from the bottom panel of the unit.

The 2-position switch located in the battery compartment must be set by the user if the power supply method is changed. The up position is for the 9-volt battery. The down position allows for either the AC adapter or the rechargeable batteries. The AC adapter will trickle charge the rechargeable batteries if they are in place or it will simply allow for line power operation of the unit.

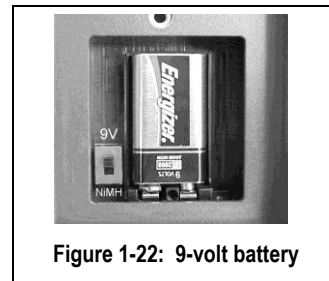

9-Volt Alkaline Battery Replacement

WARNING: Replace batteries only in a non-hazardous environment.

The 9-volt battery should be replaced or the NiMH battery pack should be recharged when the voltage drops below 6.4 volts. The battery voltage is displayed when the instrument is turned on. While turned on, the battery voltage can be displayed at any time by pressing the up or down arrow keys to move through the display until the battery voltage screen appears. If, while operating, the battery voltage drops below 6.4 volts, the display will automatically switch to the display showing the battery voltage along with a low battery message. After a low battery occurs, the unit will continue to operate for approximately 8 hours. When the battery voltage falls to 6.2 volts or below, the unit will automatically turn off.

Replace only with an approved 9-volt alkaline battery.

Approved 9-Volt Batteries

Eveready: Energizer 522, EN22, 6LR61

Duracell: MN1604

Panasonic: 6LR61, 6AM6X

Rayovac: A1604

UltraLife: U9V

NiMH Battery Pack

WARNING: Recharge batteries only in a non-hazardous environment.

The NiMH rechargeable battery pack is charged in the instrument using TSI's AC 120V AC to 9V DC adapter (part #015-910) or 220V AC to 9V DC adapter (part #015-680). A discharged battery pack requires an "overnight" charge of 16 hours (for the 120V adapter). Leaving the AC adapter plugged in for extended lengths of time or when operating the instrument will not harm the rechargeable batteries.

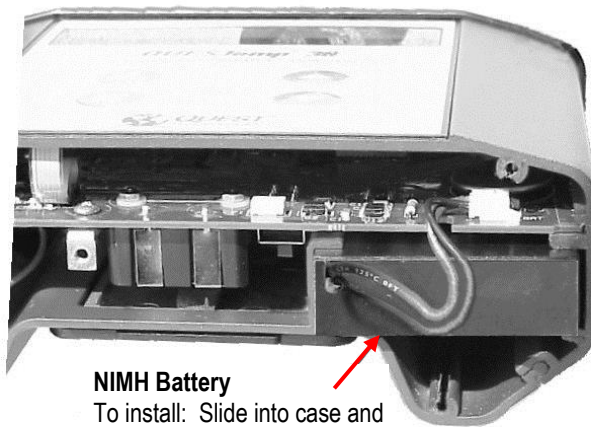

NiMH Battery

To install: Slide into case and plug in connector as shown.

Figure 1-23: NiMH rechargeable battery

Appendix A: Specifications

Measurements

- Globe temperature, dry bulb temperature, wet bulb temperature, % relative humidity, WBGT_{in}, WBGT_{out}, WBGT weighted average (if 3 sensor sets), and Heat Index / Humidex.
- Temperatures given in Celsius or Fahrenheit.

Data Logging

- Records and prints all measurements at user selected interval of 1, 2, 5, 10, 15, 30, or 60 minutes. 128K bytes of data memory.

Languages

- English, French, Spanish, Italian, German

Housing

- Designed water resistant to a light rain or mist. If rain is frequent, best practice would be to remote the sensor bar and keep the instrument sheltered.

Size

- Height 9.2 in. (23.5 cm); Width 7.2 in. (18.3 mm); Depth 3.0 in. (7.5 mm)
- Dimensions include mounted sensor assembly

Weight

- 2.6 lbs. (1.2 kg) with mounted sensor assembly

Sensor Types

- Temperature: 1000 ohm platinum RTD
- Humidity: Integrated circuit with capacitive polymer sensor

Accuracy

- Temperature: $\pm 0.5^{\circ}\text{C}$ between 0°C and 120°C
- Relative humidity: $\pm 5\%$ between 20 to 95% (non-condensing)

Operating Temperature Range

- Sensor Assembly: -5°C to $+100^{\circ}\text{C}$
- Electronics: -5°C to 60°C

Remote Sensor Bars

- 2 x 15-pin D-sub jacks are located on the side of the unit for plugging in 1 or 2 additional sensor bars by using remote cables up to 200 feet (61 m). The top sensor bar can also be remote with a cable.

Power Options

- 9V alkaline, 7.2V NiMH rechargeable pack (charged in the unit), or AC adapter wall power cube (AC adaptor will operate the unit or recharge the NiMH battery pack)

Battery Life

- 9V alkaline: 140 hours
- Rechargeable Nickel Metal Hydride: 300 hours
- (Adding additional sensor bars reduces battery life.)

Charge Time (NiMH Battery Pack)

- 16 hours (charge in the unit)

Air Probe Accessory (QUESTemp[®] 36 model only)

- Range: 0 – 20 meters per second. 0.1m/s increments
- Sensor: Omni directional heated thermistor
- Accuracy: $\pm(0.1 \text{ m/s} + 4\%)$ of measurement value
- Battery Life: 6 – 8 hours for fully charged NiMH battery
- Charge Time: 9 hours

Product markings and batteries

Year of Manufacture markings

The year of manufacture is determined by the third character in the instrument's serial number. "A" was manufactured in 2000, "B" in 2001, "C" in 2002, "I" in 2009 and so forth.

Batteries

Only the following battery types may be used:

Non-rechargeable battery

Type	Manufacturer
U9V	Ultralife
MN1604	Duracell
522 or EN22 or 6LR61	Energizer
A1604 or BR232	Rayovac
6LR61 or 6AM6	Panasonic

Rechargeable battery

Integral NiMH battery pack type DC2121

The rechargeable battery may only be recharged with class 2 charger, rated 9 VDC, 1 A max.

Appendix B: Heat Exposure Tables

ACGIH

Screening Criteria for Heat Stress Exposure. WBGT values in °C.

NOTE: According to the ACGIH's guidelines, the temperature values represent a work and rest process which is explained in the standards. Refer to the ACGIH TLVs and BEIs for specific details.

Work and recovery (TLV)	Light	Moderate	Heavy	Very Heavy
75% to 100%	31.0	28.0	26.0*	23.5*
50% to 75%	31.0	29.0	27.5	25.5*
25% to 50%	32.0	30.0	29.0	28.0
0% to 25%	32.5	31.5	30.5	30.0

Work and recovery (Action Limit)	Light	Moderate	Heavy	Very Heavy
75% to 100%	28.0	25.0	22.5*	20.0*
50% to 75%	28.5	26.0	24.0	22.5*
25% to 50%	29.5	27.0	25.5	24.5
0% to 25%	30.0	29.0	28.0	27.0

*Values not specified by ACGIH have been estimated for continuity.

Cited from American Conference of Governmental Industrial Hygienists, *Threshold Limit Values and Biological Exposure Indices for 2008*. Reprinted with permission.

ACGIH Clothing Corrections

The following clothing corrections are in degrees Celsius. When a clothing correction is entered into the setup portion of the QUESTemp^o 36, the value is added to the WBGT only for looking up the stay times. The WBGT value displayed by the unit does not reflect corrections.

Clothing type	Clothing correction (Addition to WBGT (°C))
Work clothes (long sleeve shirt and pants)	0°
Cloth (woven material) coveralls	0°
Double-layer woven clothing	3°
SMS polypropylene coveralls	0.5°
Polyolefin coveralls	1°
Limited-use vapor-barrier coveralls	11°

Cited from American Conference of Governmental Industrial Hygienists, *Threshold Limit Values and Biological Exposure Indices for 2008*. Reprinted with permission.

United States Navy

Physiological Heat Exposure Limits (PHEL) Time Table
(Without the presence of fuel combustion gases/fuel vapors)

The recommended working hours are shown based on a maximum of eight hours. Naval personnel will follow a category, I - VI, based upon their function.

PHEL Curves (Total Exposure Time in Hours: Minutes)

WBGT(F)	I	II	III	IV	V	VI
80.0	>8:00	>8:00	>8:00	8:00	6:35	4:30
81.0	>8:00	>8:00	>8:00	8:00	6:35	4:30
82.0	>8:00	>8:00	8:00	7:05	5:25	3:40
83.0	>8:00	8:00	7:45	6:25	4:55	3:20
84.0	>8:00	8:00	7:05	5:55	4:30	3:05
85.0	8:00	7:45	6:30	5:20	4:05	2:50
86.0	8:00	7:05	5:55	4:55	3:45	2:35
87.0	7:25	6:30	5:25	4:30	3:25	2:20
88.0	6:45	5:55	4:55	4:05	3:10	2:10
89.0	6:10	5:25	4:30	3:45	2:50	2:00
90.0	5:40	5:00	4:10	3:25	2:40	1:50
91.0	5:15	4:35	3:50	3:10	2:25	1:40

WBGT(F)	I	II	III	IV	V	VI
92.0	4:50	4:10	3:30	2:55	2:15	1:30
93.0	4:25	3:50	3:15	2:40	2:00	1:25
94.0	4:05	3:35	3:00	2:25	1:50	1:15
95.0	3:45	3:15	2:45	2:15	1:45	1:10
96.0	3:25	3:00	2:30	2:05	1:35	1:05
97.0	3:10	2:45	2:20	1:55	1:25	1:00
98.0	2:55	2:35	2:10	1:45	1:20	0:55
99.0	2:40	2:20	2:00	1:40	1:15	0:50
100.0	2:30	2:10	1:50	1:30	1:10	0:45
101.0	2:20	2:00	1:40	1:25	1:05	0:45
102.0	2:10	1:50	1:35	1:15	1:00	0:40
103.0	2:00	1:45	1:25	1:10	0:55	0:35
104.0	1:50	1:35	1:20	1:05	0:50	0:35
105.0	1:40	1:30	1:15	1:00	0:45	0:30
106.0	1:35	1:25	1:10	0:55	0:45	0:30
107.0	1:30	1:15	1:05	0:50	0:40	0:25
108.0	1:20	1:10	1:00	0:50	0:35	0:25
109.0	1:15	1:05	0:55	0:45	0:35	0:25
110.0	1:10	1:00	0:50	0:40	0:30	0:20
111.0	1:05	1:00	0:50	0:40	0:30	0:20
112.0	1:00	0:55	0:45	0:35	0:25	0:20
113.0	0:55	0:50	0:40	0:35	0:25	0:15
114.0	0:55	0:45	0:40	0:30	0:25	0:15
115.0	0:50	0:45	0:35	0:30	0:20	0:15
116.0	0:45	0:40	0:35	0:25	0:20	0:15
117.0	0:45	0:40	0:30	0:25	0:20	0:10
118.0	0:40	0:35	0:30	0:25	0:15	0:10
119.0	0:35	0:35	0:25	0:20	0:15	0:10
120.0	0:35	0:30	0:25	0:20	0:15	0:10
121.0	0:35	0:30	0:25	0:20	0:15	0:10
122.0	0:30	0:25	0:20	0:15	0:15	0:10
123.0	0:30	0:25	0:20	0:15	0:10	0:10

WBGT(F)	I	II	III	IV	V	VI
124.0	0:25	0:25	0:20	0:15	0:10	0:05

Electrical power research institute (EPRI)

The recommended working hours are shown based on a maximum of four hours. A time of 4:01 indicates greater than 4 hours.

WBGT°C	Light	Moderate	Heavy
28	4:01	4:01	3:00
29	4:01	4:00	2:00
30	4:01	3:00	1:30
31	4:01	2:00	1:15
32	4:00	1:30	1:00
33	3:30	1:15	0:45
34	3:00	1:00	0:40
35	2:30	0:53	0:35
36	2:00	0:45	0:30
37	1:45	0:40	0:25
38	1:30	0:35	0:20
39	1:15	0:33	0:18
40	1:00	0:30	0:15
41	0:53	0:28	0
42	0:45	0:25	0
43	0:38	0:23	0
44	0:30	0:20	0
45	0:28	0:18	0
46	0:25	0:15	0
47	0:23	0	0
48	0:20	0	0
49	0:18	0	0
50	0:15	0	0

Appendix C: Accessories

Sensor array with 2-inch globe	056-795
Sensor array with 6-inch globe	056-780
6-foot shielded remote sensor cable	053-924
25-foot shielded remote sensor cable	053-925
100-foot shielded remote sensor cable	053-926
200-foot shielded remote sensor cable	053-927
Serial computer cable.....	054-715
Parallel printer cable.....	056-875
120 VAC to 9 VDC adapter.....	015-910
220 VAC to 9 VDC adapter.....	015-680
Verification module	053-923
Tripod	059-045
Replacement wicks.....	056-679
Water bottle 2 oz.....	056-068
User's manual.....	056-663

Air Probe Accessories

NiMH battery	053-039
Dual 120 volt charger	053-037
Dual 220 volt charger	053-038

Appendix D: Detection Management Software DMS

The QUESTemp[®] 34/36 Heat Stress Monitor has the flexibility to communicate, download data, create reports, and save customized setups using the TSI Detection Management Software DMS.

DMS Quick overview

The focus of this section is to briefly explain how to download, create quick reports, and a quick overview of setup parameters. (Refer to the DMS User Manual for further instructions.)

Downloading your sessions in DMS

Once the QUESTemp[®] 34/36 is communicating and run/stops are stored on the instrument, this data may be downloaded into DMS for further analysis and reporting.

➤ Downloading your sessions

1. Download the DMS software. (**NOTE:** You may have purchased this with your instrument.)
2. Using a TSI cable, part number 054-715, plug the cable into the computer and plug the opposite end into the side jack of the QT[®]34/36 data port.

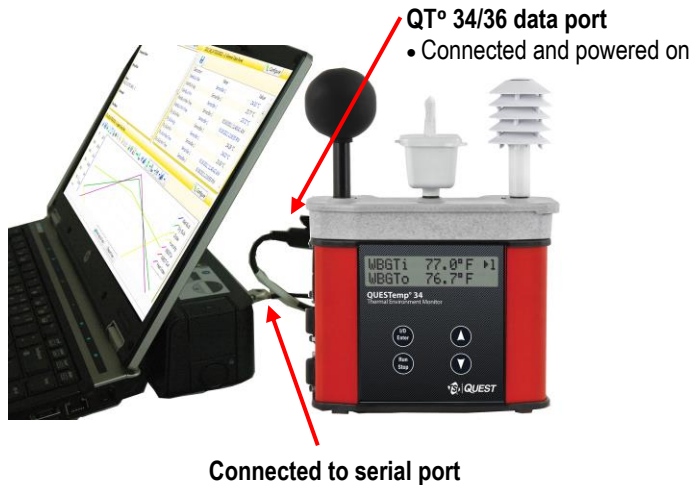

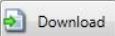

Figure 1-24: Communicating to DMS

2. Power on the QUESTemp^o 36 by pressing and holding the **I/O Enter** key.
3. Open DMS and click on  button.
4. Select **Heat Stress** and then select the **Model Type** by clicking on QT^o34 or QT^o36. (See **1** and **2**). (You are now ready to setup or download your instrument.)
5. Click in the **Data Finder** checkbox (see **3**) and then select  button (see **4**).
 - **NOTE:** When downloading, DMS will state it successfully received the files (at the bottom of the page). It will then open the Data Finder Page.

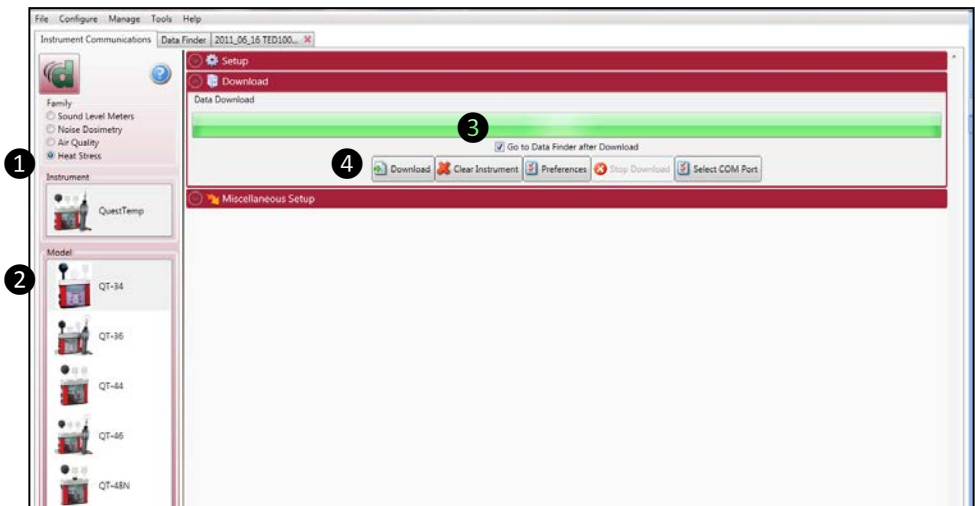

Figure 1-25: Downloading with the QT^o34/36

Viewing/Analyzing and Quick Reporting in DMS

In the **Data Finder** page, your heat stress data is stored by instrument family and then by model. There are two options in the data finder page which include analyzing and printing a quick report. See below for more details.

➤ Analyze data

- In the **Data finder** page, click a heat stress session by expanding the **Family heat stress** and selecting the session.
 - NOTE:** To view the recently downloaded data, click on **Recent** and then select the session by looking at the **Start Time/Date** field.

Double-click to select/view QT[®]34/36 data in charts and graphs

Session/Study Name	Start Time	Stop Time	Run Time	File Name	Humidity Min-1	Humidity Avg-1	Humidity Max-1
2011_06_16 TED100021 - 1	6/16/2011 9:31:45 AM	6/16/2011 9:37:45 AM	00:06:00	2011_06_16 TED100021 - 1.mdx			57 %
2011_06_16 TED100021 - 2	6/16/2011 11:08:55 AM	6/16/2011 2:18:56 PM	03:00:01	2011_06_16 TED100021 - 2.mdx	55 %	56 %	61 %
2011_06_16 TED100021 - 3	6/16/2011 3:09:56 PM	6/16/2011 4:10:56 PM	00:59:01	2011_06_16 TED100021 - 3.mdx	57 %	57 %	61 %
2011_06_20 TED100021 - 4	6/20/2011 9:29:56 AM	6/20/2011 10:29:24 AM	00:59:28	2011_06_20 TED100021 - 4.mdx			61 %
2011_06_22 TED100021 - 5	6/22/2011 3:30:41 PM	6/22/2011 3:30:48 PM	00:00:07	2011_06_22 TED100021 - 5.mdx			57 %
2011_06_06 TED100021 - 22	6/6/2011 5:00:06 AM	6/6/2011 5:00:11 AM	00:00:05	2011_06_06 TED100021 - 22.mdx			53 %

Figure 1-26: Data Finder page (Analyze/Quick Report options)

2. The session page layout will appear.
 - **Work items ①** – select either the session or study (in order to view appropriate data).
 - **Add panel ②** – double-click on a chart/table type and it will appear as a panel on your screen.
 - **Arrange panels ③** – displays the displays the order of the charts/tables which appear in the panel layout. Also, when a chart/table is selected in the arrange panels palette, the associated data panel is selected. The resize handles are applied and the panel is brought into view allowing you to resize/reposition. To delete a panel, right-click on a chart/table and press delete from your keyboard.
 - **Data Panels ④** – used to view your measurement and/or parameters from your study.

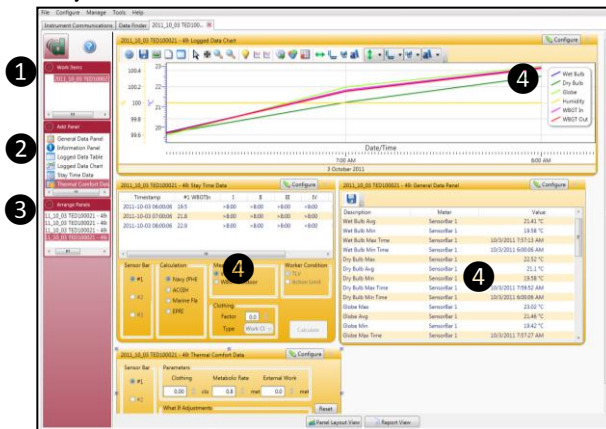





Figure 1-27: Data layout page (displays your data in charts and graphs)

Reporting and Printing

If you are in the Data finder page, you have the option to select  button and this will give you a report instantaneously using a standard template of graphs and charts (also called panels.).

- **Viewing reports:** if you are in the data layout page and you have rearranged the charts/tables, the report will print in the sequence in which they appear on the screen.
- **Printing reports:** while in the report view page you have two options outlined below:
 - Click on the  icon from the title bar.
 - Click on the  icon from the session report title bar.

Customize the report by inserting on-site testing images

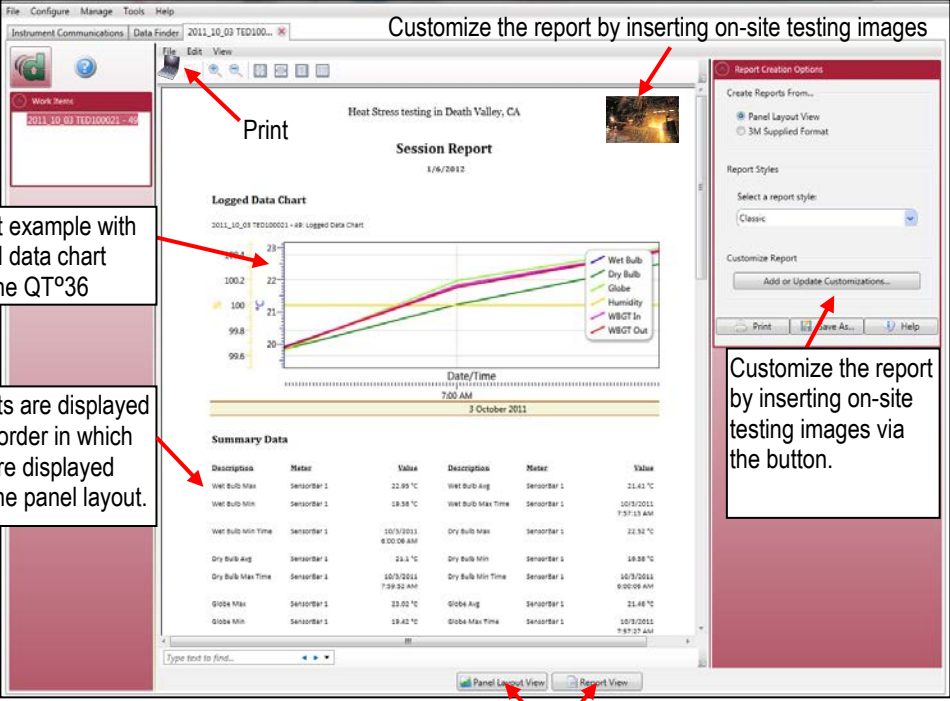

Print

Session Report
1/6/2012

Logged Data Chart
2011_10_03 TED100021 - 48 - Logged Data Chart

Description	Value	Description	Value
Wet Bulb Max	Sensor#1 22.95 °C	Wet Bulb Avg	Sensor#1 21.43 °C
Wet Bulb Min	Sensor#1 18.38 °C	Wet Bulb Max Time	Sensor#1 10/3/2011 9:37:24 AM
Wet Bulb Min Time	Sensor#1 10/3/2011 6:00:06 AM	Dry Bulb Max	Sensor#1 22.51 °C
Dry Bulb Avg	Sensor#1 21.3 °C	Dry Bulb Min	Sensor#1 18.38 °C
Dry Bulb Max Time	Sensor#1 10/3/2011 7:39:32 AM	Dry Bulb Min Time	Sensor#1 10/3/2011 6:00:06 AM
Globe Max	Sensor#1 23.02 °C	Globe Avg	Sensor#1 21.48 °C
Globe Min	Sensor#1 19.42 °C	Globe Max Time	Sensor#1 10/3/2011 7:67:27 AM

Report Creation Options

Create Reports From...

Panel Layout View
 3M Supplied Format

Report Styles

Select a report style:

Classic

Customize Report

Add or Update Customizations...

Print Save As... Help

Panel Layout View Report View

Report example with logged data chart from the QT*36

Reports are displayed in the order in which they are displayed from the panel layout.

Customize the report by inserting on-site testing images via the button.

Quickly switch back to the panel layout view (charts & tables)

Figure 1-28: Reporting and printing

Contact/Service information

This section gives directions for contacting TSI Incorporated for technical information and directions for returning the QUESTemp° 34/36 for service.

Technical Support Contacts

If you have any difficulty setting or operating the instrument, or if you have technical or application questions about this system, contact TSI's Technical Support.

North America and Asia Pacific	Europe, Middle East, and Africa
Telephone: 1-800-680-1220 (USA); +1 651-490-2860 (Outside USA)	Telephone: +49 241-52303-0
Fax: +1 651-490-3824	Fax: +49 241 52303-49
E-mail: technical.services@tsi.com	E-mail: tsigmbh@tsi.com

Service Contact Information

If your instrument does not operate properly, or if you are returning the instrument for service, visit our website at <http://rma.tsi.com> for a Return Material Authorization, or contact Customer Service.

North America and Asia Pacific	Europe, Middle East, and Africa
TSI Incorporated 1060 Corporate Center Drive Oconomowoc, WI 53006-4828	TSI Instruments Ltd. Stirling Road Cressex Business Park High Wycombe, Bucks HP12 3ST United Kingdom
Telephone: 1-800-680-1220 (USA); +1 651-490-2860 (Outside USA)	Telephone: +44 (0) 149 4 459200
E-mail: technical.services@tsi.com	E-mail: tsiuk@tsi.com

Returning for Service

Visit our website at <http://rma.tsi.com> and complete the on-line “Return Merchandise Authorization” form or call TSI at 1-800-680-1220 (USA) or (651) 490-2860, or 001 651 490 2860 (International) for specific return instructions.

Customer Service will need the following information:

- The instrument model number
- The instrument serial number
- A purchase order number (unless under warranty)
- A billing address
- A shipping address

Use the original packing material to return the instrument to TSI. If you no longer have the original packing material, seal off any ports to prevent debris from entering the instrument and ensure that the display and the connectors on the instrument front and back panels are protected. This instrument is very fragile and must be packed in a manner appropriate for a precision instrument.

Calibration

The QUESTemp[®] 34/36 heat stress monitor and TSI field calibrator devices should be examined regularly by the factory. An annual calibration is recommended. (See Service Information above.)

Warranty

(For country-specific terms and conditions outside of the USA, please visit www.tsi.com.)

Seller warrants the goods, excluding software, sold hereunder, under normal use and service as described in the operator's manual, to be free from defects in workmanship and material for **12 months**, or if less, the length of time specified in the operator's manual, from the date of shipment to the customer. This warranty period is inclusive of any statutory warranty. This limited warranty is subject to the following exclusions and exceptions:

- a. Hot-wire or hot-film sensors used with research anemometers, and certain other components when indicated in specifications, are warranted for 90 days from the date of shipment;
- b. Pumps are warranted for hours of operation as set forth in product or operator's manuals;
- c. Parts repaired or replaced as a result of repair services are warranted to be free from defects in workmanship and material, under normal use, for 90 days from the date of shipment;
- d. Seller does not provide any warranty on finished goods manufactured by others or on any fuses, batteries or other consumable materials. Only the original manufacturer's warranty applies;
- e. This warranty does not cover calibration requirements, and seller warrants only that the instrument or product is properly calibrated at the time of its manufacture. Instruments returned for calibration are not covered by this warranty;
- f. This warranty is **VOID** if the instrument is opened by anyone other than a factory authorized service center with the one exception where requirements set forth in the manual allow an operator to replace consumables or perform recommended cleaning;
- g. This warranty is **VOID** if the product has been misused, neglected, subjected to accidental or intentional damage, or is not properly installed, maintained, or cleaned according to the requirements of the manual. Unless specifically authorized in a separate writing by Seller, Seller makes no warranty with respect to, and shall have no liability in connection with, goods which are incorporated into other products or equipment, or which are modified by any person other than Seller.

The foregoing is **IN LIEU OF** all other warranties and is subject to the LIMITATIONS stated herein. **NO OTHER EXPRESS OR IMPLIED WARRANTY OF FITNESS FOR PARTICULAR PURPOSE OR MERCHANTABILITY IS MADE. WITH RESPECT TO SELLER'S BREACH OF THE IMPLIED WARRANTY AGAINST INFRINGEMENT, SAID WARRANTY IS LIMITED TO CLAIMS OF DIRECT INFRINGEMENT AND EXCLUDES CLAIMS OF CONTRIBUTORY OR INDUCED INFRINGEMENTS. BUYER'S EXCLUSIVE REMEDY SHALL BE THE RETURN OF THE PURCHASE PRICE DISCOUNTED FOR REASONABLE WEAR AND TEAR OR AT SELLER'S OPTION REPLACEMENT OF THE GOODS WITH NON-INFRINGEMENTS GOODS.**

TO THE EXTENT PERMITTED BY LAW, THE EXCLUSIVE REMEDY OF THE USER OR BUYER, AND THE LIMIT OF SELLER'S LIABILITY FOR ANY AND ALL LOSSES, INJURIES, OR DAMAGES CONCERNING THE GOODS (INCLUDING CLAIMS BASED ON CONTRACT, NEGLIGENCE, TORT, STRICT LIABILITY OR OTHERWISE) SHALL BE THE RETURN OF GOODS TO SELLER AND THE REFUND OF THE PURCHASE PRICE, OR, AT THE OPTION OF SELLER, THE REPAIR OR REPLACEMENT OF THE GOODS. IN THE CASE OF SOFTWARE, SELLER WILL REPAIR OR REPLACE DEFECTIVE SOFTWARE OR IF UNABLE TO DO SO, WILL REFUND THE PURCHASE PRICE OF THE SOFTWARE. IN NO EVENT SHALL SELLER BE LIABLE FOR LOST PROFITS, BUSINESS INTERRUPTION, OR ANY SPECIAL, INDIRECT, CONSEQUENTIAL OR INCIDENTAL DAMAGES. SELLER SHALL NOT BE RESPONSIBLE FOR INSTALLATION, DISMANTLING OR REINSTALLATION COSTS OR CHARGES. No Action, regardless of form, may be brought against Seller more than 12 months after a cause of action has accrued. The goods returned under warranty to Seller's factory shall be at Buyer's risk of loss, and will be returned, if at all, at Seller's risk of loss.

Buyer and all users are deemed to have accepted this LIMITATION OF WARRANTY AND LIABILITY, which contains the complete and exclusive limited warranty of Seller. This LIMITATION OF WARRANTY AND LIABILITY may not be amended, modified or its terms waived, except by writing signed by an Officer of Seller.

Service Policy

Knowing that inoperative or defective instruments are as detrimental to TSI as they are to our customers, our service policy is designed to give prompt attention to any problems. If any malfunction is discovered, please contact your nearest sales office representative, or call TSI's Customer Service department at 1-800-874-2811 (USA) or +001 (651) 490-2811 (International).



TSI Incorporated – Visit our website www.tsi.com for more information.

USA **Tel:** +1 800 874 2811
UK **Tel:** +44 149 4 459200
France **Tel:** +33 1 41 19 21 99
Germany **Tel:** +49 241 523030

India **Tel:** +91 80 67877200
China **Tel:** +86 10 8219 7688
Singapore **Tel:** +65 6595 6388

