



BCU 460, 465



Burner control units BCU 460, 465

- Replaces the local control cabinet
- For burners in intermittent operation or in continuous operation
- Flame control by UV, ionization or a further option of using the furnace chamber temperature
- Display of the program status, unit parameters and flame signal; manual mode for burner adjustment and for diagnostic purposes
- Visualization and adaptation to the specific application via the PC programming and diagnostic software BCSofT to simplify logistics management.
- Air valve control on BCU..L relieves the furnace control
- Optional PROFIBUS DP interface
- EC type-tested and certified
- Certified for systems up to SIL 3 and compliant with PL e

Application



The BCU unites the functionally interrelated components of automatic burner control unit, ignition transformer, Manual/Automatic mode and display of operating and fault statuses in a compact metal housing.

The burner control units BCU 460 and BCU 465 control, ignite and monitor gas burners for intermittent or continuous operation. As a result of their fully electronic design, they react quickly to various process requirements and are therefore suitable for frequent cycling operation.

They can be used for directly ignited industrial burners of unlimited capacity. The burners may be modulating or stage-controlled. The BCU is installed near the burner to be monitored.

On industrial furnaces, the BCU reduces the load on the central furnace control by taking over tasks that only relate to the burner, for example it ensures that the burner always ignites in a safe condition after it has been restarted.

The optional air valve control on the BCU..L assists the furnace control for cooling, purging and capacity control tasks.

The BCU 465..L is fitted with air flow monitoring and pre- and post-ventilation for use on recuperative burners.

The program status, the unit parameters and the level of the flame signal can be read directly from the unit. The burner can be controlled manually for commissioning and diagnostic purposes.

If the local requirements on the burner control unit change, the PC software BCSoft can be adjusted to the unit parameters of the application by using the optical interface.

The service personnel is supported by a convenient visualization system of the input and output signals and the error history.

The new power management scheme reduces installation and wiring costs. The power for the valves and ignition transformer is supplied via the power supply of the BCU, protected by a replaceable fine-wire fuse.

The conventional wide-spread systems used in industrial furnace and kiln construction require bridging of large distances for signal processing. The optionally available BCU..B1 for connection to the PROFIBUS DP fieldbus is equipped for this purpose.

As a standardized fieldbus system, the PROFIBUS DP considerably reduces development, installation and commissioning costs compared to conventional wiring.

The use of a standard bus system offers massive benefits compared to manufacturer-specific bespoke solutions. Time-tested hardware components, standardized connection methods and a series of tools of bus diagnostics and optimization are available on the market from a whole range of manufacturers. The widespread use of the system ensures that the planning and service personnel are very familiar with how the system operates and how to handle it and can therefore operate the system efficiently.



Roller hearth kiln in the ceramics industry



BCU on radiant tube burner

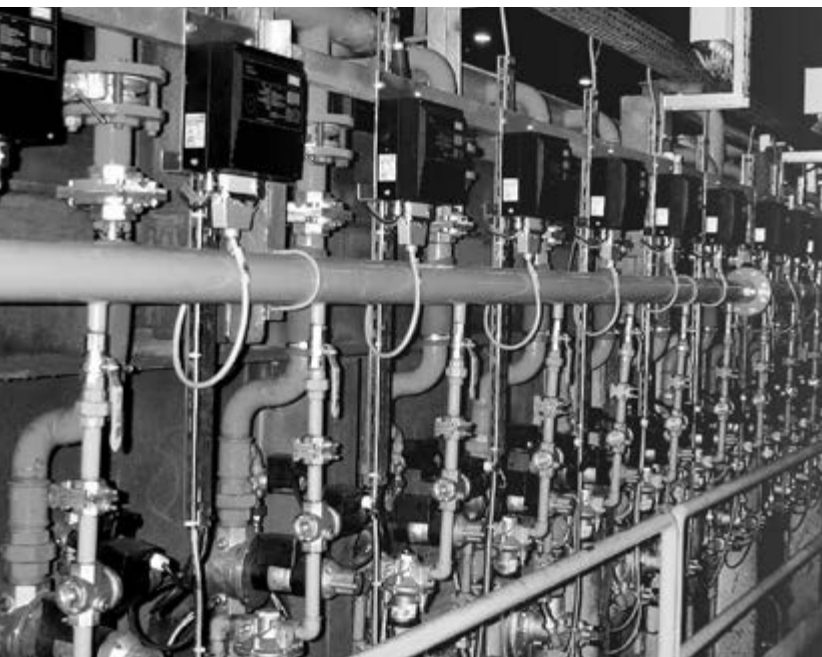

Hardening furnace with lots of industrial burners located side-by-side

Examples of application

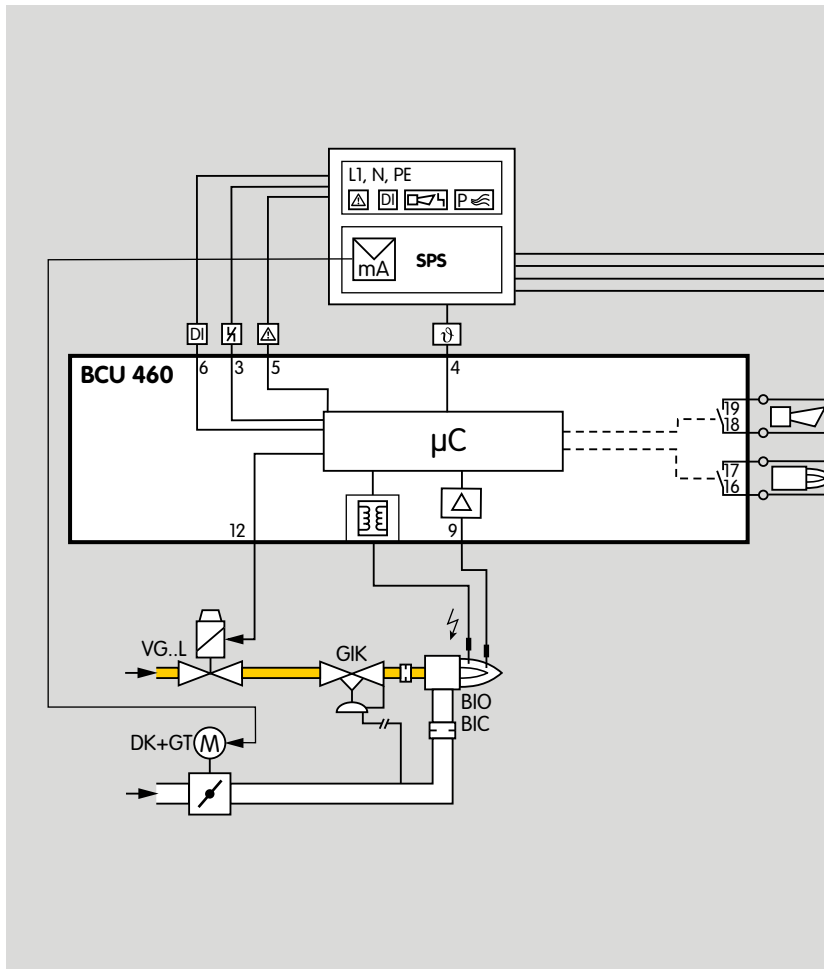

BCU 460: Modulating-controlled burner

Control: continuous.

The external control system moves the butterfly valve for air to ignition position. The burner starts at low-fire rate, and a controller controls the burner capacity via the butterfly valve for air after the operating state has been signalled.

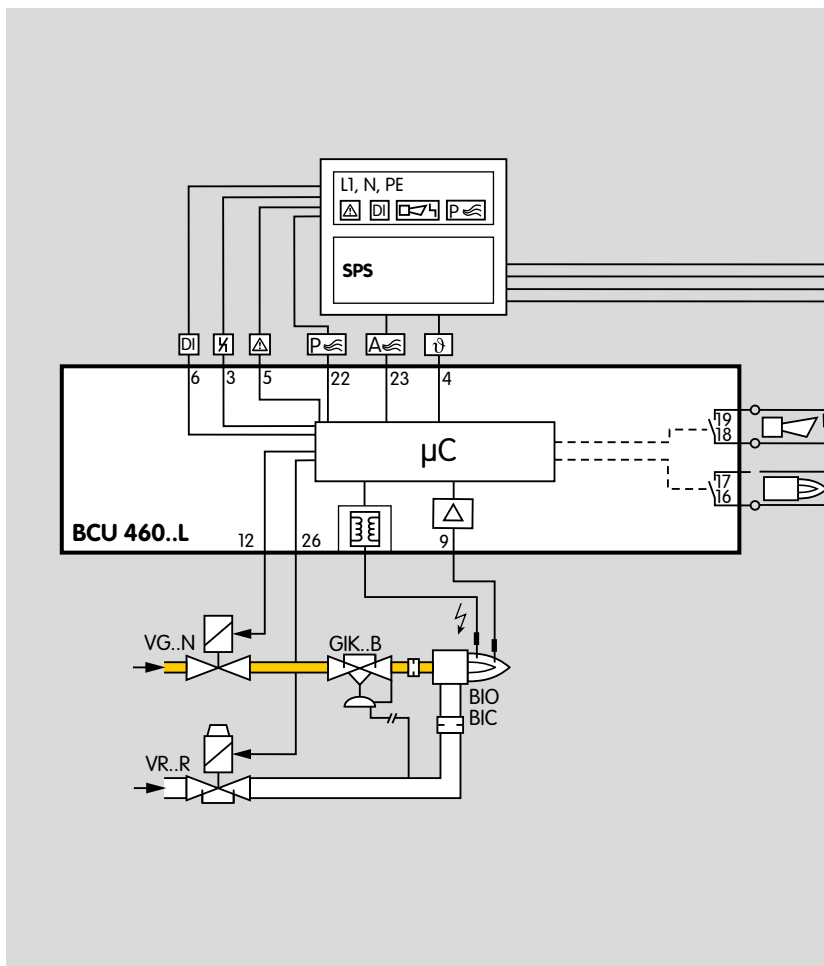

BCU 460..L: Two-stage-controlled burner

Control: ON/OFF or ON/HIGH/LOW/OFF intermittent operation.

The BCU supports the cooling and purging processes. The burner starts at low-fire rate. When the operating state is reached, the BCU advises the control unit. The PLC can now pulse the air valve in order to control the burner capacity.

BCU 465..L: Single-stage-controlled burner

Control: ON/OFF.

The gas/air mixture is adjusted to the requirements of the applications using the differing parameters of pre- and post-ventilation. The pressure switch monitors the air flow in the air supply line or in the flue gas exhaust.

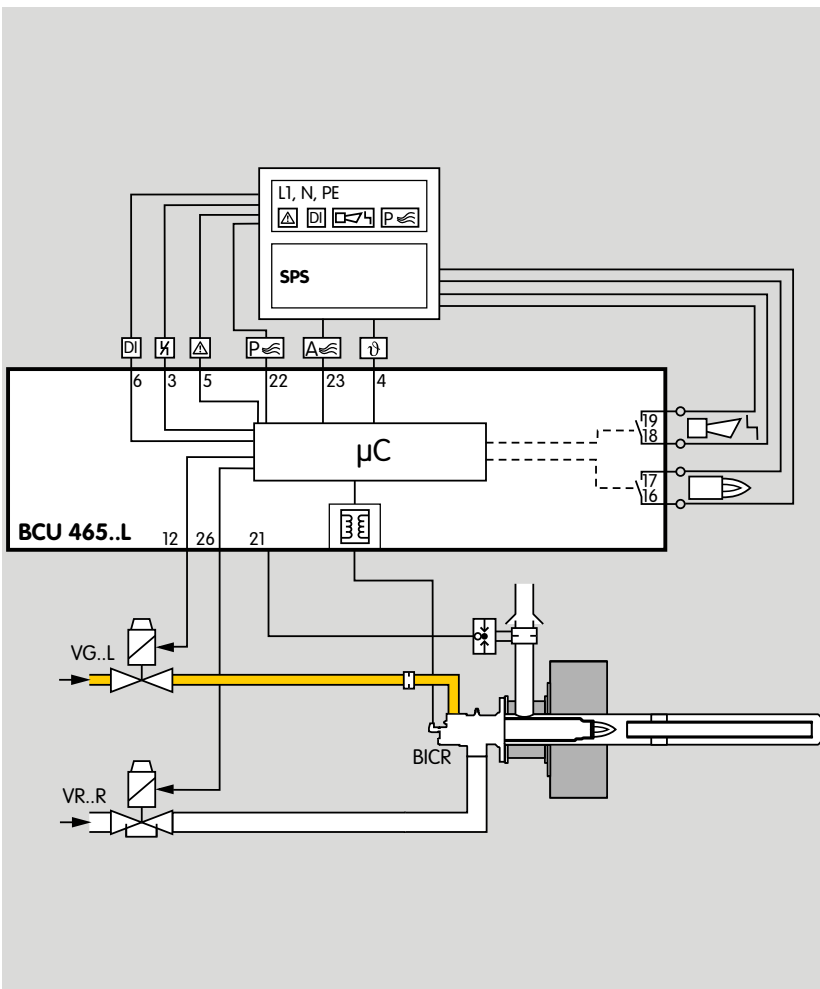
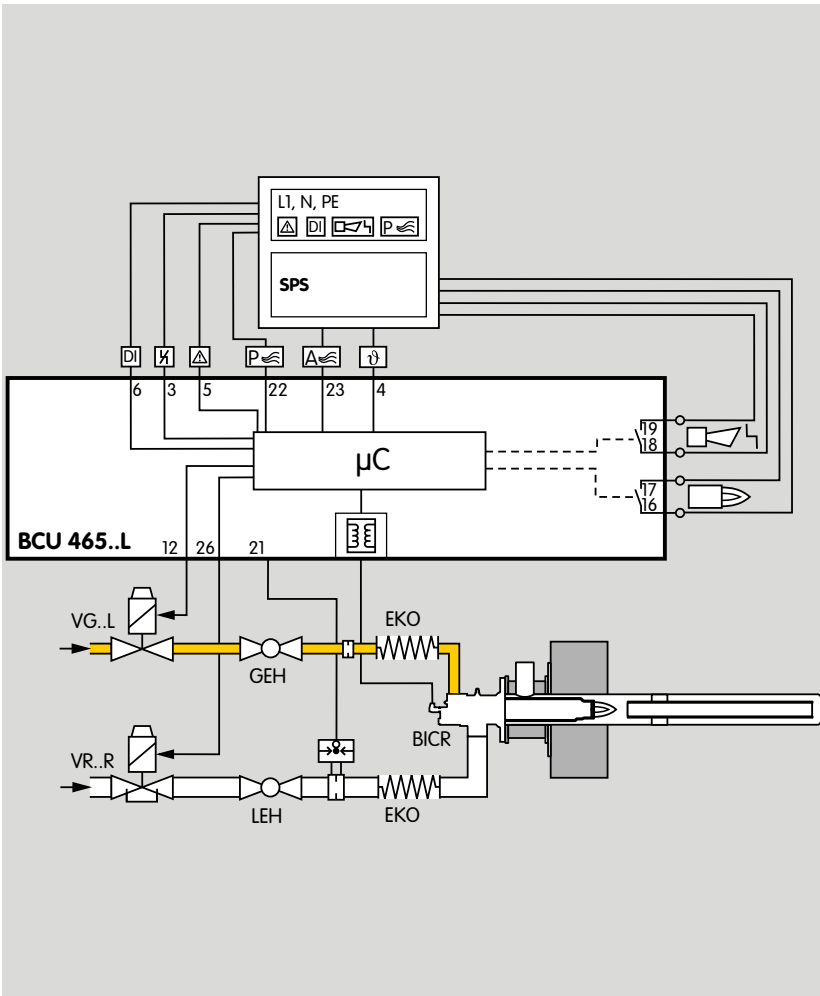

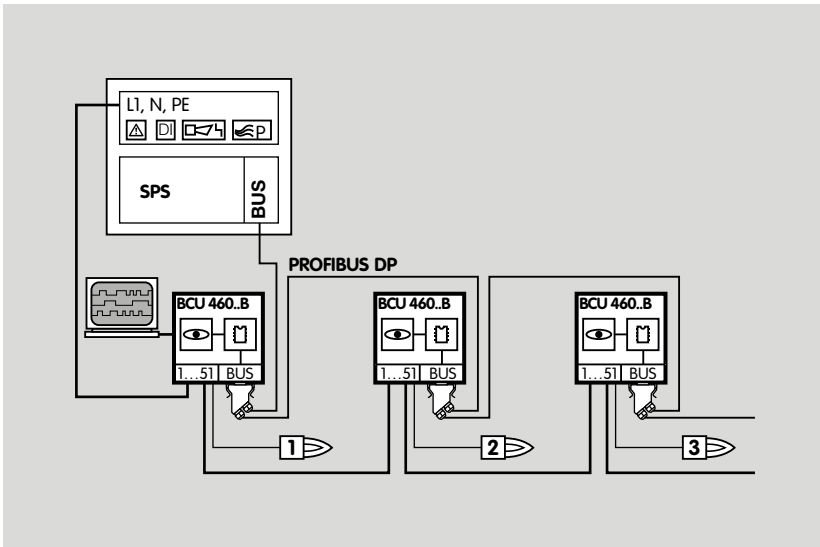

BCU 460..B1 for PROFIBUS DP

The bus system transfers the control signals for starting, resetting and for controlling the air valve from the control system (PLC) to the BCU..B1. In the opposite direction it sends operating status, the level of the flame signal and the current program status.

Control signals that are relevant for safety, such as the safety interlocks and digital input, are transferred independently of the bus communication by separate cables.

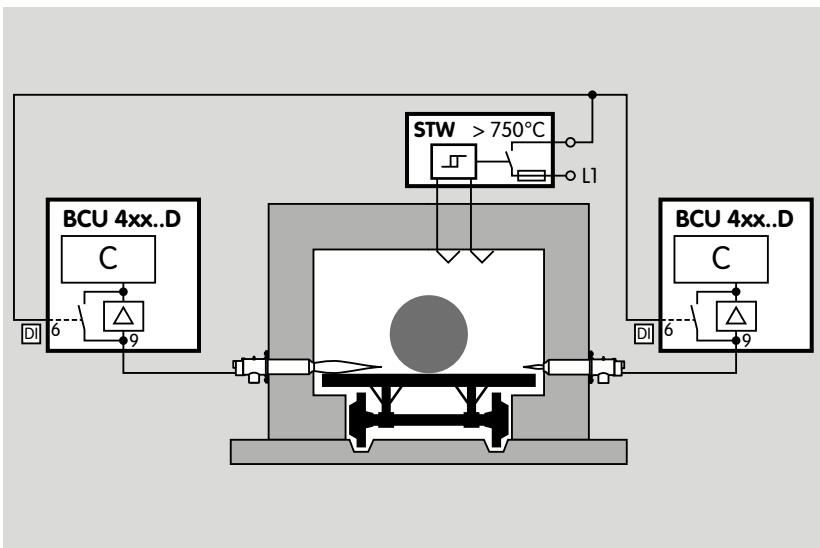

BCU 460..D: High temperature equipment

Indirect flame control using the temperature. During the start-up process, as long as the wall temperature is below auto ignition temperature, the flame must be controlled by conventional methods. When the working temperature has exceeded 750°C, the safety temperature monitor (STM) takes over the indirect flame control.

Type code

Code	Description
BCU	Burner control unit
4	Series 4
60	Standard version
65	Extended air control
3; 5; 10	Safety time on start-up t_{SA} [s]
1; 2	Safety time during operation t_{SB} [s]
L*	Air valve control
5*; 15*; 25*	Low fire over-run time [s]
W	Mains voltage: 230 V AC, -15/+10%, 50/60 Hz
R	115 V AC, -15/+10%, 50/60 Hz
1*	Ignition transformer: TZI 5-15/100
2*	TZI 7-25/20
3*	TZI 7,5-12/100
8*	TZI 7,5-20/33
GB*	Front film in English with additional stickers in D, F, I, NL, E
P*	Industrial plug connector
D2*	High temperature operation in conjunction with: ... UVS
D3*	... ionization sensor or UVD
S2* - 3*	Number of start-up attempts
A*	Air flow monitoring
O*	Position indicator feedback
U*	Preparation for UV sensor for continuous operation UVD 1
C*	Additional signal distribution
B1*	For PROFIBUS DP
/1*	9-pin D-Sub bus plug connector
E1*	Power management via phase (L1)

* If "none", this specification is omitted. Please quote the default parameter settings when ordering.

Technical data

Mains voltage:

230 V AC, -15/+10%, 50/60 Hz,

115 V AC, -15/+10%, 50/60 Hz

For grounded and ungrounded mains.

For intermittent or continuous operation.

Maximum length of ignition cable with integrated electronic ignition: 5 m (16.4 ft).

Maximum length of ionization/UV cable: 50 m (164 ft).

Number of operating cycles:

Relay outputs: 250,000 pursuant to EN 298,

Mains switch: 1,000,

Reset/Information button: 1,000.

Ambient temperature: -20 to +60°C, no condensation permitted.

Enclosure: IP 54 pursuant to IEC 529.

Die-cast aluminium housing with plug-in terminal blocks and plug-in M20 cable glands or (16-pin) plug connector for input signals and optionally pre-assembled cables for output signals.

Technical Information bulletin for this product

www.docuthek.com

Search term:

BCU 460, 465

Contact

www.kromschroeder.com → Process Heat → Sales

Elster GmbH

Strothweg 1 · 49504 Lotte (Büren)

Germany

Tel. +49 541 1214-0

hts.lotte@honeywell.com

www.kromschroeder.com

We reserve the right to make technical modifications in the interests of progress.
Copyright © 2018 Elster GmbH
All rights reserved.

Honeywell
kromschroeder