



DG..C



ERC

PL

SIL

CE



c **RA** US

c **UL** LISTED US

Pressure switch for gas

- Little space required thanks to compact dimensions
- Double pressure switch for minimum and maximum gas pressure monitoring in one unit
- Customized versions with fixed switching points can be supplied by agreement
- Several connection facilities using various lower sections
- Available with sealant-coated external thread
- Certified for systems up to SIL 3 and PL e

Application

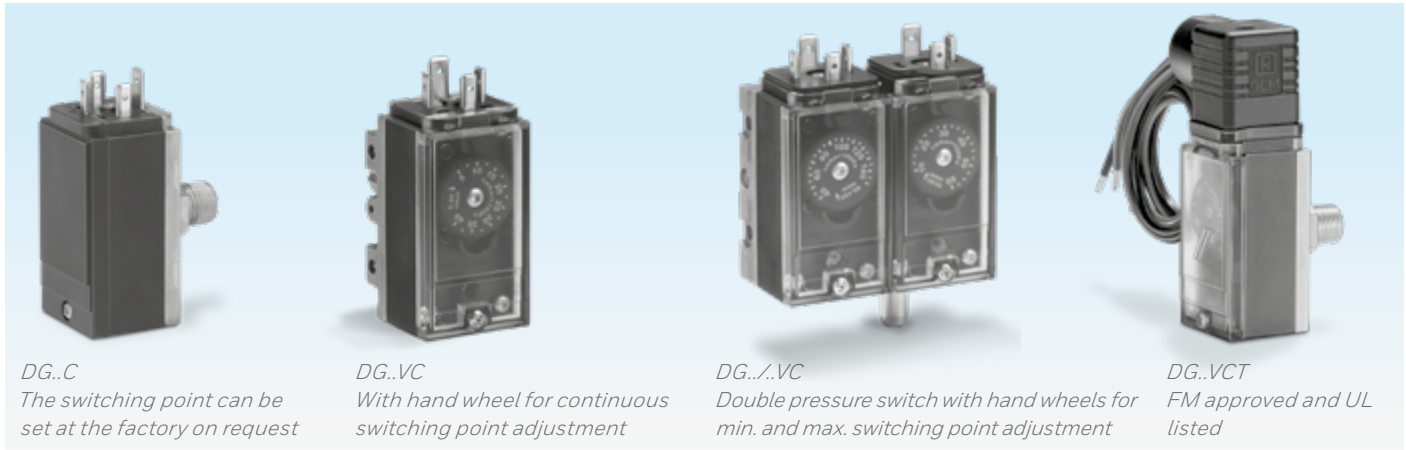

DG..C monitors the increasing or decreasing positive pressure of natural gas, town gas, LPG, flue gas, biologically produced methane and air e.g. on a gas control line.

If the gas pressure either exceeds or falls short of a set switching point, an NO contact or a change-over contact will switch in the pressure switch. With the DG..VC, the switching point may be adjusted using a hand wheel.

The DG..VC is suitable for heating boilers, for example, which are operated with LPG as well as natural gas.

In the case of the double pressure switch DG../.VC, the minimum and maximum switching point can be set on two hand wheels. Using this func-

tion, a system is controlled to prevent gas deficiencies and excess gas pressure. For pressure control it requires only one gas connection. The electrical connections can be fed in from one direction.

For attachment to gas solenoid valves or pressure regulators from the valVario range, or to CG combination controls, the DG..C is attached to the control with the flat sealing lower section.

The pressure switch DG..C is easy to install and is available with an internal or an external thread connection. For the external thread connection, the DG..C can be provided with a sealant. The sealant is approved and non-setting.

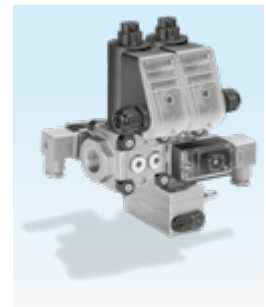

Compact design for space-saving installation, e.g. on valVario controls

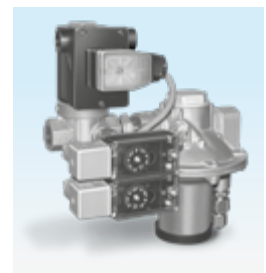

Double pressure switch DG../.VC fitted onto gas solenoid valve VG

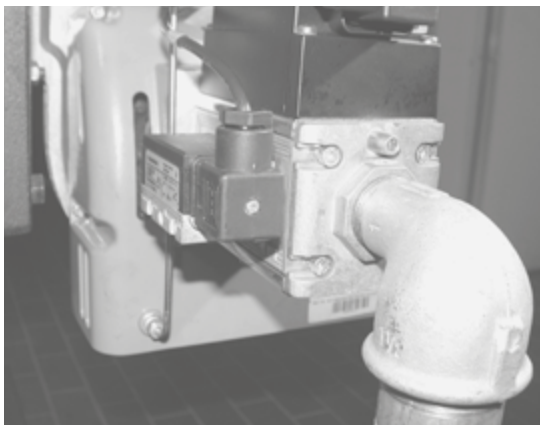

For monitoring the gas inlet pressure on heating burners



Gas inlet pressure monitoring on high-performance boilers



Gas train in a brickworks

Examples of application

Boilers

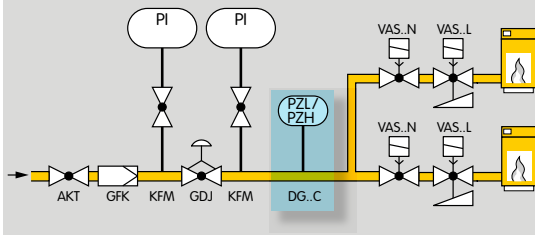

The DG..C controls the minimum or maximum gas inlet pressure on high-performance boilers.

Low-pressure cut-off and high gas pressure protection device

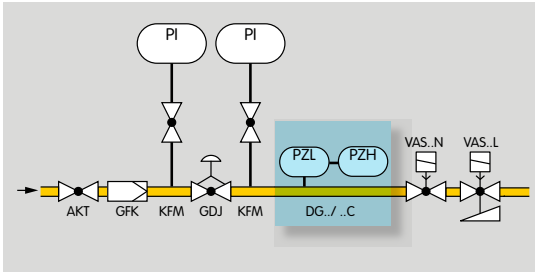

If the pressure is either too high or too low, the double pressure switch DG../.C switches in order to avoid start-up or to initiate a safety shut-down.

Fan monitoring

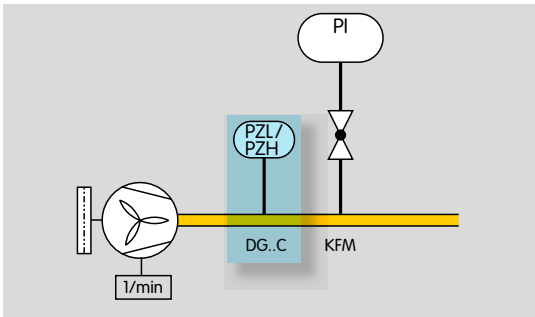

On forced draught burners, the minimum or maximum pressure is retrieved by the burner control unit via the pressure switch DG..C. If the set switching point is exceeded or undershot, the fan will either be switched on or off by the burner control unit.

Type code

Code	Description	
DG	Pressure switch for gas	
15 - 500	Max. setting in mbar	
/15 - /500 ¹⁾	Max. 2nd setting in mbar	
V	Switching point adjustable on hand wheel	
C	Compact design	
T	T-product range	
1	Attachment methods: Connection for valVario Connection at the side for CG 15 - 30 2 x Rp 1/4 internal thread (1/4 NPT), 1 x pressure test point Rp 1/4 internal thread (1/4 NPT) Rp 1/8 external thread (1/8 NPT) Rp 1/4 external thread (1/4 NPT) Optional connection for valVario controls	
3		
4 ²⁾		
5 ²⁾		
6		
8		
9		
D		Sealant (for external thread only)
-5 ²⁾		4-pin plug, without socket
-6 ³⁾	4-pin plug, with socket	
S	NO contact	
W	Change-over contact	
G	With gold-plated contacts	

¹⁾ Double pressure switch only available with 2 x Rp 1/4 internal thread connection, of which 1 has a pressure test point attached.

²⁾ DG..VCT with 4-pin plug, without socket is UR recognized.

³⁾ DG..VCT with 4-pin plug, with socket and connection leads is UL listed.

Attachment methods

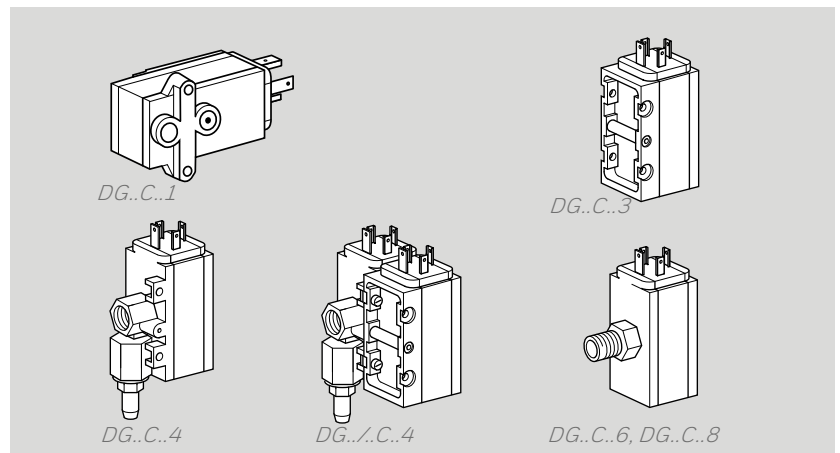

Technical data

Gas type: natural gas, town gas, LPG (gaseous), flue gas, biologically produced methane (max. 0.1 %-byvol. H₂S) and air.

Max. inlet pressure p_{\max} = withstand pressure = 600 mbar (8.5 psig).

Max. test pressure for testing the entire system: temporarily < 15 minutes 2 bar (29 psig).

Switching capacity:

DG..C, 24 – 250 V AC:

I = 0.05 – 5 A at $\cos \varphi = 1$,

I = 0.05 – 1 A at $\cos \varphi = 0.6$.

DG..C..G, 5 – 250 V AC:

I = 0.01 – 5 A at $\cos \varphi = 1$,

I = 0.01 – 1 A at $\cos \varphi = 0.6$.

DG..C..G, 5 – 48 V DC: I = 0.01 – 1 A.

DG..VCT, 30 – 240 V AC:

I = 5 A at $\cos \varphi = 1$,

I = 0.5 A at $\cos \varphi = 0.6$.

DG..VCT..G, < 30 V AC:

I = 0.1 A at $\cos \varphi = 1$,

I = 0.05 A at $\cos \varphi = 0.6$.

If the DG..C..G (DG..VCT..G) has switched a voltage > 24 V (> 30 V) and a current > 0.1 A at $\varphi = 1$ or > 0.05 A at $\varphi = 0.6$ once, the gold plating on the contacts will have been burnt through. It can then only be operated at this power rating or higher power rating.

Maximum medium and ambient temperatures:

DG..C: -20 to +70°C (-4 to +158°F),

DG..CT: -15 to +60°C (5 to 140°F).

Long-term use in the upper ambient temperature range accelerates the ageing of the elastomer materials and reduces the service life (please contact manufacturer).

Storage temperature:

-20 to +40°C (-4 to +104°F).

Diaphragm pressure switch, silicone-free.

Diaphragm: NBR.

Housing: glass fibre reinforced PBT plastic with low gas release.

Lower housing section: AlSi 12.

Enclosure:

IP 54 pursuant to DIN EN 60529 with standard socket to DIN EN 175301-803,

IP 00 with AMP plug.

Safety class: 1.

Weight: 60 g (2.12 oz).

Weight: 270 to 320 g (9.5 to 11.3 oz), depending on equipment.

Maintenance cycles

We recommend a function check once a year.

Technical Information bulletin for this product

www.docuthek.com

Search term: DG..C

Contact

www.kromschroeder.com → Process Heat → Sales

Elster GmbH

Strothweg 1 · 49504 Lotte (Büren)

Germany

Tel. +49 541 1214-0

hts.lotte@honeywell.com

www.kromschroeder.com

We reserve the right to make technical modifications in the interests of progress.
Copyright © 2018 Elster GmbH
All rights reserved.

Honeywell
kromschroeder