

Burner control unit PFU 780

Technical Information · GB
6 Edition 02.12l

- For pilot and main burners of unlimited capacity in thermoprocessing equipment pursuant to EN 746-2
- Separate flame control for pilot burner and main burner by UV, ionisation or a further option of using the furnace chamber temperature
- Display of the program status, unit parameters and flame signal; Manual mode for burner adjustment and for diagnostic purposes



Table of contents

Burner control unit PFU 780	1	4.5.1 Safety time on start-up t_{SA}	31
Table of contents	2	4.5.2 Flame proving period t_{FS}	32
1 Application	4	4.5.3 Minimum combustion time t_B	32
1.1 Examples of application	6	4.5.4 Burner start-up attempts	33
1.1.1 Stage-controlled main burner with alternating pilot burner	6	4.6 Behaviour during operation	35
1.1.2 Stage-controlled main burner with permanent pilot burner	7	4.6.1 Safety time during operation t_{SB} for pilot and main burners	35
1.1.3 Modulating-controlled burner	8	4.6.2 Fault lock-out or restart, pilot burner	35
1.1.4 PFU 780..D: High temperature equipment	9	4.6.3 Fault lock-out or restart, main burner	37
2 Certification	10	4.7 Air valve control PFU..L	39
3 Function	11	4.7.1 Purge	39
3.1 Connection diagram	11	4.7.2 Cooling in start-up position/standby	39
3.1.1 PFU 780	11	4.7.3 Burner start	39
3.1.2 PFU 780..K2	12	4.7.4 Air valve opens in the case of external activation (not during start-up)	40
3.2 PFU 780 program sequence	13	4.7.5 Air valve opens in the case of external activation (even during start-up)	41
3.3 Program status and fault messages	16	4.7.6 Air valve opens with valve V2	42
4 Parameters	18	4.7.7 Air valve opens with operating signal	43
4.1 Scanning the parameters	19	4.7.8 Low fire over run time t_{KN} after a normal shut-down	44
4.2 Flame control	20	4.7.9 Behaviour of the air valve in the event of a fault lock-out	45
4.2.1 Flame signal, pilot burner	20	4.8 Manual operation	46
4.2.2 Flame signal, main burner	20	4.8.1 Manual mode limited to 5 minutes	46
4.2.3 Program status when the most recent fault occurred	20	4.9 Password	47
4.2.4 Switch-off threshold of the flame amplifier	20	5 Selection	48
4.2.5 High temperature operation with PFU..D	21	5.1 Calculating the safety time t_{SA}	48
4.2.6 UVS check	24	5.2 Selection table	49
4.3 Pilot and main burner monitoring	25	5.2.1 Type code	49
4.3.1 Permanent pilot burner	27	6 Project planning information	50
4.3.2 Interrupted pilot burner	28	6.1 Cable selection	50
4.4 Behaviour in start-up position/standby	29	6.1.1 Ignition cable	50
4.4.1 Flame simulation check in start-up position/standby	29	6.1.2 Ionisation cable	50
4.4.2 Minimum burner pause time t_{BP}	30	6.1.3 UV-Leitung	50
4.5 Behaviour during start-up	31	6.2 Ignition electrode	50
		6.2.1 Electrode gap	50

6.2.2 Star electrodes	50	8.6 Socket connectors	57
6.3 Minimum combustion time	51	8.7 Module subrack	57
6.4 Safety interlocks (Limits)	51	8.8 Power supply PFP 700	58
6.5 Emergency stop	52	8.9 Relay module PFR 704	59
6.5.1 In the event of fire or electric shock	52	8.10 Field bus interface PFA 700	60
6.5.2 Via the safety interlocks (limits)	52	8.11 Impulse system MPT 700	61
6.6 Reset	52	9 Technical data	62
6.6.1 Parallel reset	52	9.1 Safety-specific characteristic values	64
6.6.2 Permanent remote reset	52	9.2 Operating controls	65
6.6.3 Automatic remote reset (PLC)	52	10 Maintenance cycles	66
6.6.4 Burner start	52	11 Legend	67
6.6.5 Restart and start-up attempts	52	12 Glossary	68
6.7 Fault message	53	12.1 Waiting time t_W	68
6.8 Protecting the pilot burner from overload	53	12.2 Safety time on start-up t_{SA}	68
6.9 Installation	53	12.3 Ignition time t_Z	68
6.10 Wiring	53	12.4 Flame simulation/Flame simulation delay time t_{LV}	68
6.10.1 UVS sensor wiring	53	12.5 Safety time during operation t_{SB}	69
6.11 PFU switched off	53	12.6 Flame signal	69
6.12 Furnace control	54	12.7 Fault lock-out	69
6.13 Note on EC type-examination	54	12.8 Safety interlocks (Limits)	69
6.14 Mains switch	54	12.9 Pilot gas valve V1	69
6.15 Changing parameters	54	12.10 Main gas valve V2	69
7 Flame control	55	12.11 Continuous operation	70
7.1 With ionisation sensor	55	12.12 Air valve	70
7.2 With UV sensor	55	12.13 Diagnostic coverage DC	70
7.3 Via the temperature in high temperature equipment	55	12.14 Mode of operation	70
8 Accessories	56	12.15 Safe failure fraction SFF	70
8.1 High-voltage cable	56	12.16 Probability of dangerous failure PFH_D	70
8.2 BCSoft	56	12.17 Mean time to dangerous failure $MTTF_d$	70
8.3 Stickers for labelling	56	Feedback	71
8.4 "Changed parameters" stickers	56	Contact	71
8.5 Radio interference suppressed electrode adapters	57		

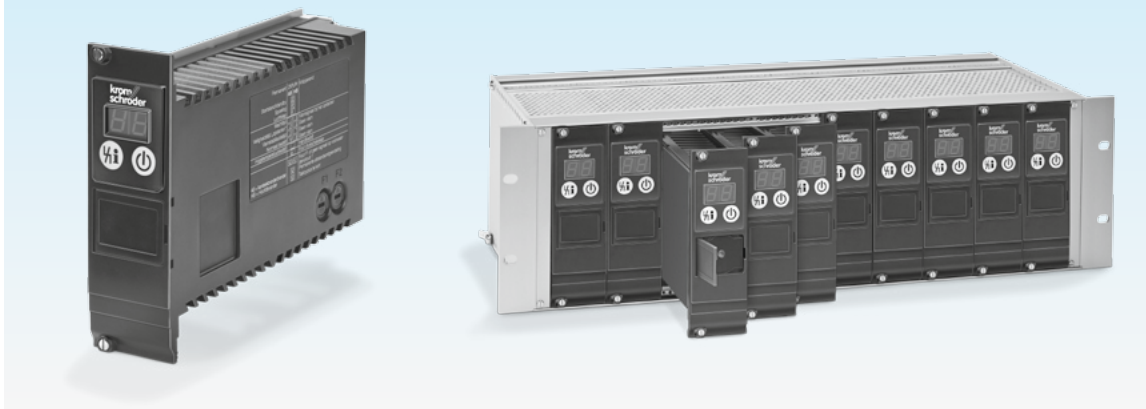

Module subrack BGT for instance serves to accommodate several function units. It is provided with a backplane with screw terminals for simple, reliable wiring.

1 Application

The burner control units PFU 780 control, ignite and monitor gas burners for intermittent or continuous operation. As a result of their fully electronic design they react quickly to various process requirements and are therefore also suitable for frequent cycling operation.

The PFU 780 can be used for industrial burners of unlimited capacity which are ignited by pilot burners. Pilot and main burners are controlled and monitored independently. This reduces the main burner start-up time. The pilot burner can burn permanently or be switched off. The main burners may be modulating or stage-controlled.

On industrial furnaces, the PFU 780 reduces the load on the central furnace control by taking over tasks that only relate to the burner, for example it ensures that

the burner always ignites in a safe condition after it has been restarted.

The burner control unit is used for burners with mechanical combustion air supply where the fan is controlled by a separate logic and for atmospheric burners. The air valve control on the PFU 780L assists the furnace control for cooling, purging and capacity control tasks.

The program status, the unit parameters and the level of the flame signal can be read directly from the unit. Pilot and main burners can be controlled manually for commissioning and diagnostic purposes.



Application

If the local requirements on the burner control units change, the PC software BCSoft can be adjusted to the unit parameters of the application by using the optical interface.

To support service personnel, BCSoft offers a convenient visualisation system of the input and output signals and the error history.



Bogie hearth forging furnace in the metallurgical industry

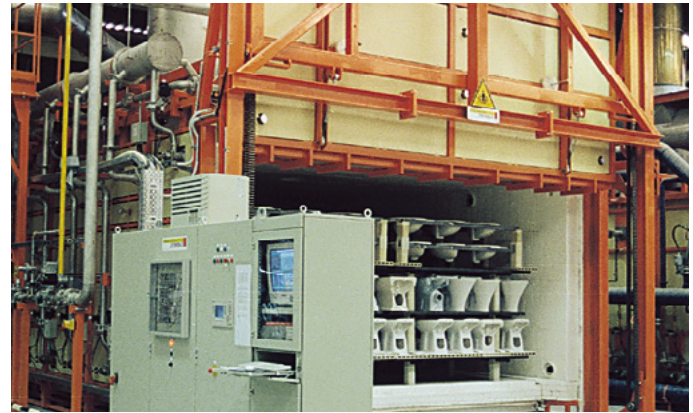

Intermittent shuttle kiln in the ceramics industry



Walking beam furnace with overhead firing

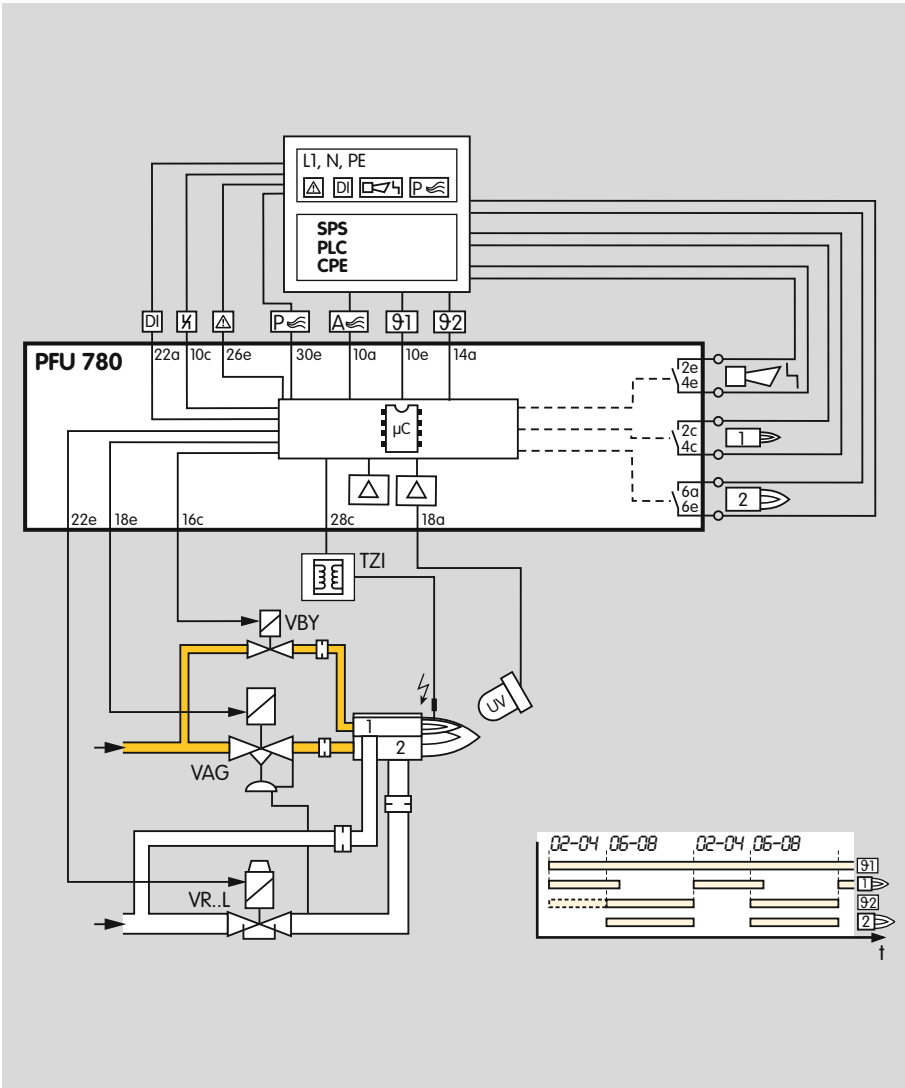

1.1 Examples of application

1.1.1 Stage-controlled main burner with alternating pilot burner

Control: Main burner ON/OFF.

The main burner can be started with reduced capacity after the operating signal from the pilot burner has been detected. The pilot burner is switched off automatically after the main burner has started up. When the main burner is switched off, the pilot burner automatically switches on again.

A UV sensor monitors the flame signal from pilot and main burners. UV sensor UVD 1 is used for continuous operation, UV sensor UVS for intermittent operation.

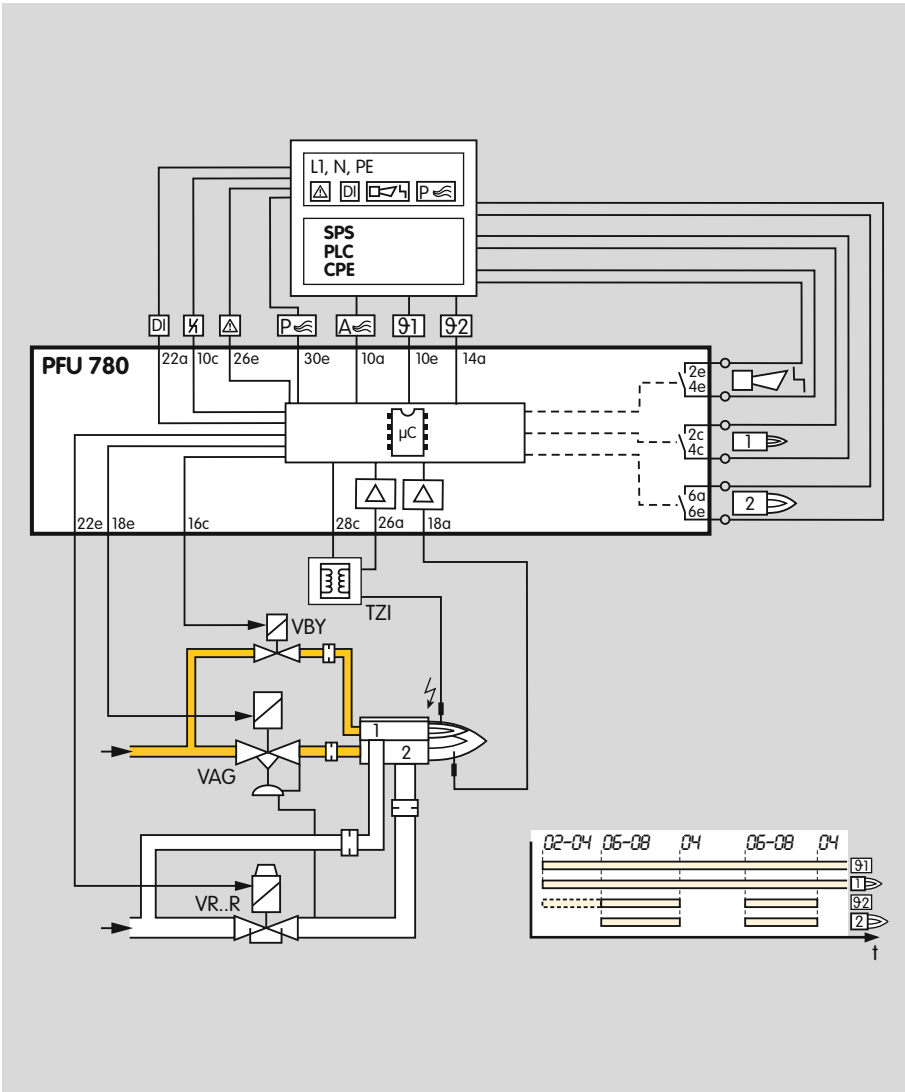

1.1.2 Stage-controlled main burner with permanent pilot burner

Control: Main burner ON/OFF.

The main burner can be started with reduced capacity after the operating signal from the pilot burner has been detected. Pilot and main burners can be operated simultaneously. Both are ionisation-controlled independently.

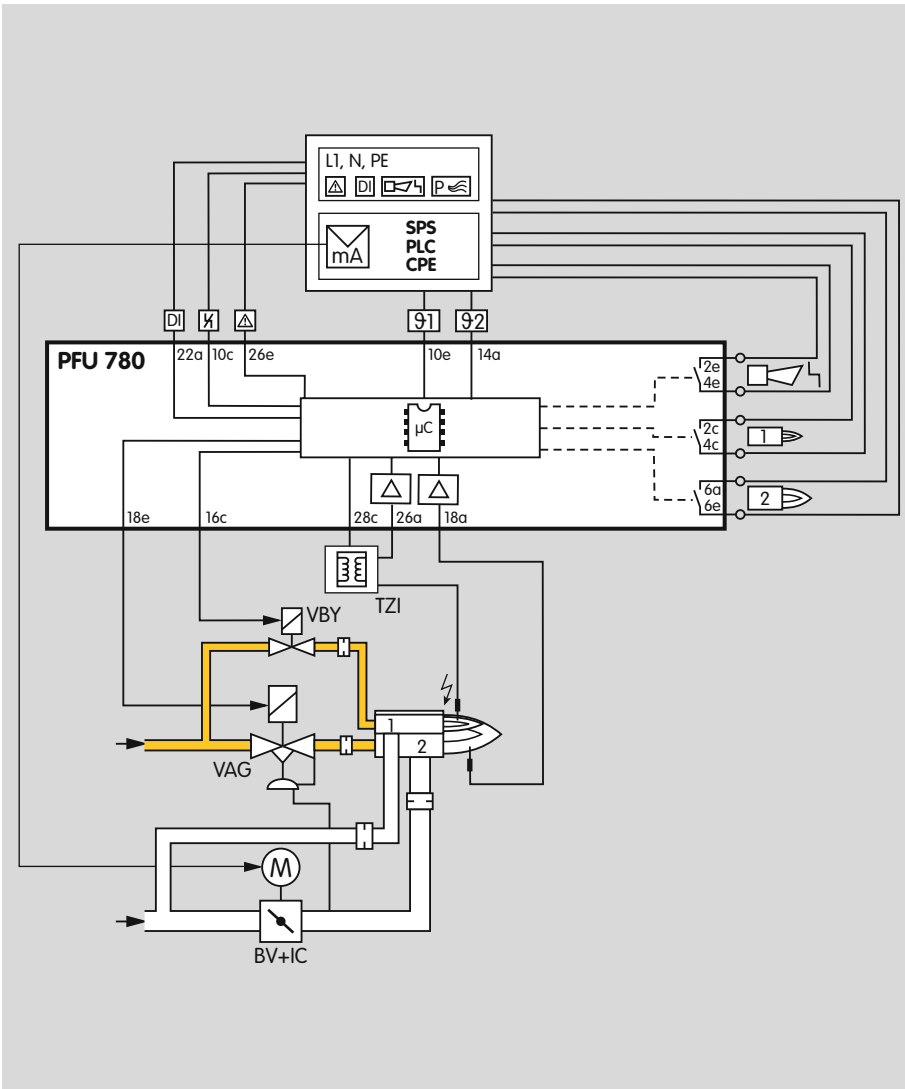

1.1.3 Modulating-controlled burner

Control: Main burner continuous

The butterfly valve for air BV is moved to ignition position in order to start the main burner. The main burner can be started at low-fire rate after the operating signal from the pilot burner has been detected. The control system controls the burner capacity via the butterfly valve for air BV after the operating state has been signalled. Pilot and main burners can be operated simultaneously.

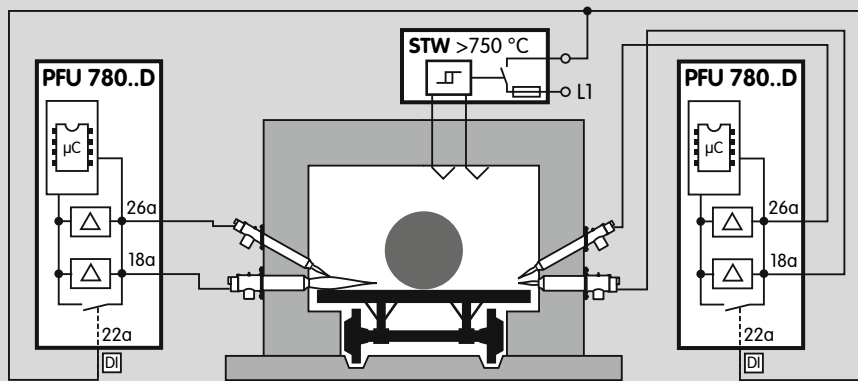

1.1.4 PFU 780..D: High temperature equipment

The flame is controlled indirectly on the basis of the temperature. During the start-up process, as long as the wall temperature is below auto ignition temperature the flame must be controlled by conventional methods. When the working temperature has exceeded $750^{\circ}C$, the safety temperature monitor (STW) takes over the indirect flame control.

2 Certification

Certified pursuant to SIL



For systems up to SIL 3 pursuant to EN 61508

Pursuant to EN ISO 13849-1:2006, Table 4, the PFU can be used up to PL e.

EC type-tested and certified



pursuant to

- Gas Appliances Directive (2009/142/EC) in conjunction with EN 298:2004-01,

Meets the requirements of the

- Low Voltage Directive (2006/95/EC),
- EMC Directive (2004/108/EC).

PFU..T is FM approved



Factory Mutual Research Class: 1997.

Suitable for applications pursuant to NFPA 86.

www.approvalguide.com

AGA approved



Australian Gas Association, Approval No.: 5597
www.aga.asn.au/product_directory

3 Function

3.1 Connection diagram

For cable selection and wiring, see page 50 (Project planning information).

3.1.1 PFU 780

For the explanation of symbols, see page 67 (Legend).

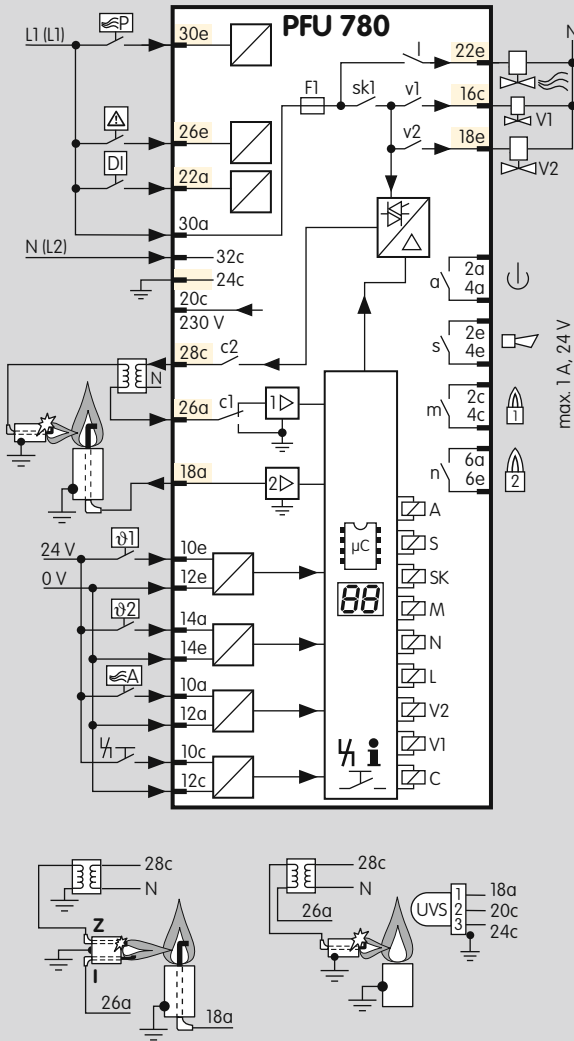

3.1.2 PFU 780..K2

As a replacement unit for burner control unit PFU 798.
For the explanation of symbols, see page 67 (Legend).

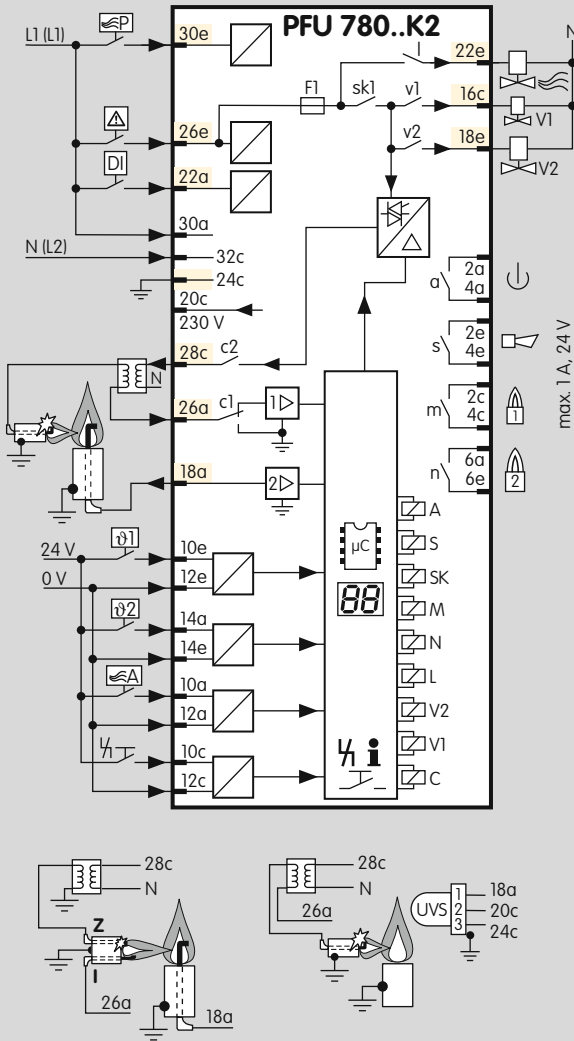

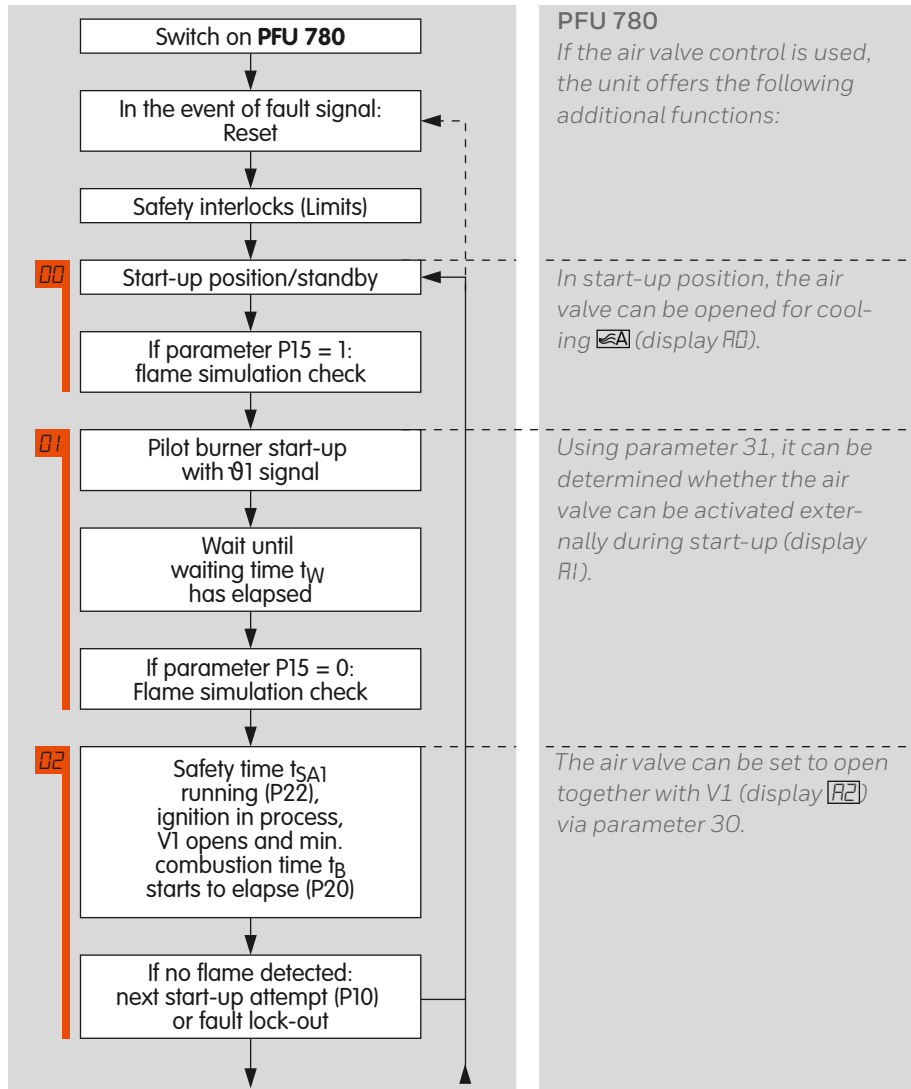

3.2 PFU780programsequence

Normal start-up

If an “old” fault is still being signalled after switching on, it will be necessary to reset this first.

The safety interlocks (terminal 26e) must be closed and the burner control unit must be switched on.

The PFU 780 conducts a self-test when in the start-up position (the burner is switched off). If it does not determine a malfunction of the internal electronic circuitry or of the flame sensors, the burner can be started. The pilot burner start-up is activated via the signal input “Start-up signal 91” (terminal 10e). Once the start-up signal 91 has been applied, the PFU 780 opens valve V1 and ignites the burner. The ignition time t_z is constant. If a flame is detected during the safety time t_{SA1} , the flame proving period t_{FS1} starts after the safety time t_{SA1} has elapsed.

If the pilot burner has been started successfully and its flame has stabilised, the burner control unit issues the Enable signal for main burner operation. The operation signalling contact for the pilot burner (terminals 2c/4c) closes.



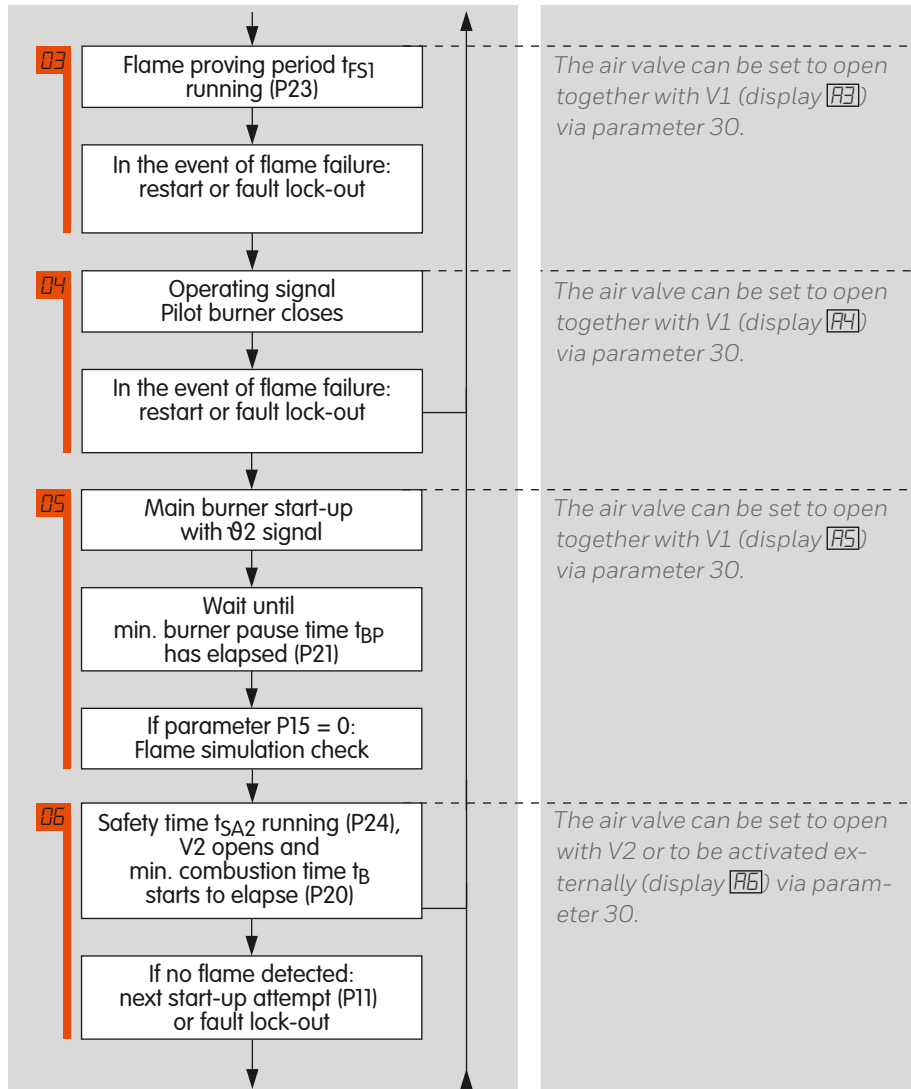

The PFU coordinates the correct program run for the pilot and main burners. The main burner can be started via the signal input “Start-up signal $\theta 2$ ” (terminals 14a/14c) if required.

Once the start-up signal $\theta 2$ has been applied (terminals 14a and 14e), the PFU 780 opens valve V2. The main burner is ignited by the pilot burner.

If a flame is detected during the safety time t_{SA2} , the flame proving period t_{FS2} starts after the safety time t_{SA2} has elapsed. If the main burner has been started successfully and its flame has stabilised, the operation signalling contact (terminals 6a/6e) closes.

Start-up of the pilot burner without flame signal

If no flame is detected during the safety time t_{SA1} , either a fault lock-out occurs or up to three further start-up attempts occur. (Parameter 10, “Pilot burner start-up attempts”).



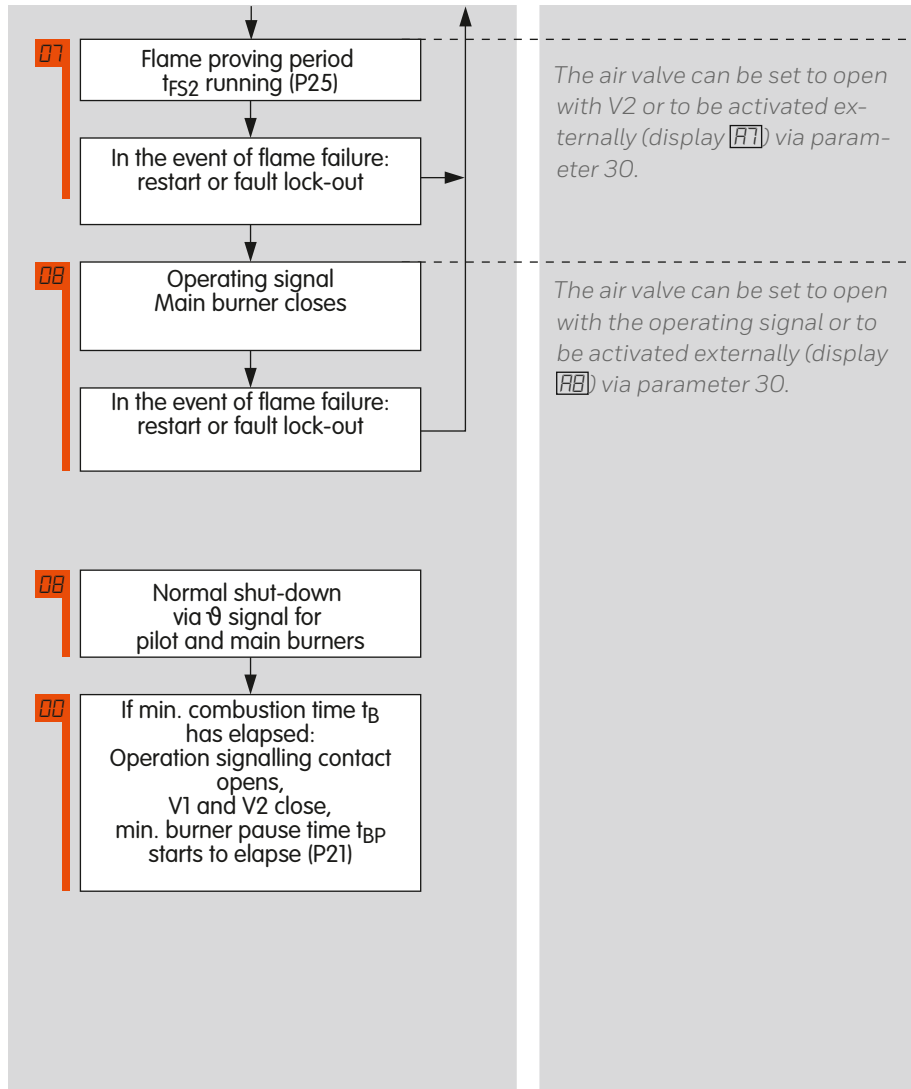

Behaviour of the pilot burner in the event of flame failure during operation

If the flame fails during operation, either an immediate fault lock-out occurs or a restart occurs. This procedure can be set via the optical interface (parameter 12, “Pilot burner restart”).

Behaviour of the main burner in the event of flame failure during start-up

If no flame is detected during the safety time t_{SA2} , either a fault lock-out occurs or up to three further start-up attempts occur. (Parameter 11, “Main burner start-up attempts”).

Behaviour of the main burner in the event of flame failure during operation

If the flame fails during operation, either an immediate fault lock-out occurs or a restart occurs. This procedure can be set via the optical interface (parameter 13, “Main burner restart”).

3.3 Program status and fault messages

During operation, the 7-segment display shows the program status. In the event of a fault, the PFU halts the program run, the display blinks and it then displays the cause of the fault.

The burner control unit can be reset using the Reset button or the remote reset.

Program status	DISPLAY	Fault message (blinking*)
Start-up position/standby	00	
Cooling	RD	
Waiting time/Pause time	1	Flame simulation, pilot burner
Safety time on start-up, pilot burner	2	Start-up without flame signal, pilot burner
Flame proving period, pilot burner	3	Flame failure during flame proving period, pilot burner
Operation, pilot burner	4	Flame failure during operation, pilot burner
Waiting time, main burner	5	Flame simulation, main burner
Safety time on start-up, main burner	6	Start-up without flame signal, main burner
Flame proving period, main burner	7	Flame failure during flame proving period, main burner
Operation, main burner	8	Flame failure during operation, main burner
Purge	PD	
Air valve	R	
High temperature operation**	..	
	10	Faulty remote reset
	32	Supply voltage too low
	33	Faulty parameterisation
	35	Short-circuit on a valve output
	36	Short-circuit on ignition or valve output
	51	Safety interlock failure



Function

Program status	DISPLAY	Fault message (blinking*)
	52	Permanent reset
	53	Time between two start-ups is too short

In Manual mode, two dots will blink on the display in program status 01 – 08.

** *Optionally available.*

4 Parameters

Description	Parameter	Value range	Factory default setting	Adjustable*
Flame signal, pilot burner	01	0 – 30 μ A		
Flame signal, main burner	02	0 – 30 μ A		
Program status when the most recent fault occurred	03	x0 – x8		
Switch-off threshold, pilot burner	04	1 – 20 μ A	1 μ A	●
Switch-off threshold, main burner	05	1 – 20 μ A	1 μ A	●
Start-up attempts, pilot burner	10	1 – 4	1	
Start-up attempts, main burner	11	1 – 4	1	
Restart, pilot burner	12	0; 1	0	●
Restart, main burner	13	0; 1	0	●
Safety time during operation for V1 and V2 t_{SB}	14	1; 2 s	1 s	●
Flame simulation check in start-up position/standby	15	0; 1	1	●
Permanent pilot burner	16	0; 1	1	●
Minimum combustion time t_B	20	25 s	t_{SA}	●
Minimum burner pause time t_{BP}	21	0 – 250 s	0 s	●
Pilot burner safety time on start-up t_{SA1}	22	3; 5; 10 s		●
Pilot burner flame proving period t_{FS1}	23	0 – 25 s	0 s	●
Main burner safety time on start-up t_{SA2}	24	3; 5 s		●
Main burner flame proving period t_{FS2}	25	0 – 25 s	0 s	●
Air valve control	30	0; 2; 3	0	●
Air valve can be activated externally on start-up	31	0; 1	0	●
Air valve closed/can be activated in the event of malfunction	32	0; 1	1	●
High temperature operation**	33	2; 3		



Description	Parameter	Value range	Factory default setting	Adjustable*
Manual mode limited to 5 minutes	34	0; 1	1	●
UVS check (1 x in 24 hours)	35	0; 1	0	●
Low fire over run time	36	0; 5; 15; 25 s	0 s	●
Purge	42	0; 1	1	●
Multi-flame control	45	0; 1	0	●
Password	50	0000 – 9999	1234	●

* Adjustable using BCSoft software and a PC opto-adapter

** Please quote in your order.

0 = Function inactive

1 = Function active

On parameterisation, ensure that the program sequence started matches the application. Select the parameters so that the burner can restart as intended in all operating phases.

4.1 Scanning the parameters

During operation, the 7-segment display shows the program status.

The flame signal and all following parameters of the PFU can be scanned one after the other by repeatedly pressing the Reset/Information button (for 2 s).

In the event of a fault, the PFU halts the program run, the display blinks and it then displays the cause of the fault in coded form.

4.2 Flame control

4.2.1 Flame signal, pilot burner

Parameter 01

Flame signal of the pilot burner, display in μA , measuring range: 0 – 30 μA .

4.2.2 Flame signal, main burner

Parameter 02



Flame signal of the main burner, display in μA , measuring range: 0 – 30 μA .

4.2.3 Program status when the most recent fault occurred

Parameter 03

Program status when the most recent fault occurred

This indicates the program status in which the last burner fault occurred (e.g. the unit indicates that a flame simulation has been detected with a blinking ).

In parameter 03, it is now shown which program position the unit was in when the fault was detected (waiting time  or standby .

Result: A flame simulation was detected during the waiting time or standby.

4.2.4 Switch-off threshold of the flame amplifier

Parameter 04, pilot burner switch-off threshold

Parameter 05, main burner switch-off threshold

The sensitivity at which the burner control unit still detects a flame can be set between 1 and 20 μA .

Example: In the case of UV control with the UV sensor UVS, the signal of the burner to be monitored is influenced by other burners.

The set value can be incremented in parameter 04 so that only the flame of the system's "own" burner is detected.

The measured flame signal of the system's "own" burner should be at least 3 μA (empirical value) higher than the set switch-off threshold.

4.2.5 High temperature operation with PFU..D

Parameter 33

Operation of firing systems at temperatures above 750°C. The PFU features a safety-relevant DI input (Digital Input). This input supports the “High temperature operation” function. If firing systems are operated above 750°C, the system is considered to be a high temperature equipment (see EN 746-2). Flame control must be in operation until the furnace wall temperature has exceeded 750°C. Note the requirements of the Standards!

Flame control can be dispensed with during high temperature operation to improve the system availability. This means that no incorrect flame signals, e.g. signals from a UV sensor which are interpreted as extraneous signals due to reflection of UV radiation, may lead to faults.

When the DI input is activated, the burner control unit reverts to High temperature mode. This means: the PFU operates without evaluation of the flame signal. The safety function of the device-internal flame control system is placed out of operation.

In High temperature mode, the gas valves are opened without flame control.

The precondition for high temperature operation is that an external flame safeguard ensures the presence of the flame in fail-safe manner indirectly via the temperature. For this purpose, we recommend a safety tem-

perature monitor with twin thermocouple (DIN 3440). Sensor discontinuity, sensor short-circuit, failure of a component or mains failure must set the installation to a safe state.

The voltage may be applied to the DI input (terminal 22a) so as to activate High temperature mode only when the temperature at the furnace wall has exceeded 750°C. The PFU starts the burner as usual, without monitoring the presence of the flame.

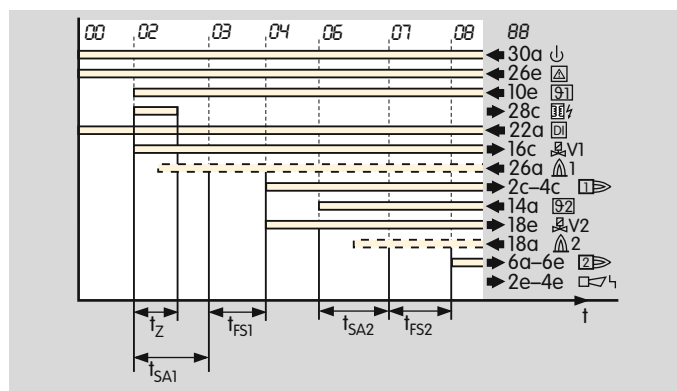

If the temperature in the furnace chamber drops below 750°C, the DI input must be disconnected from the electrical power supply and the furnace must be operated with the internal flame control system.

Parameters

The PFU then responds, depending on setting:

Parameter 33 = 1

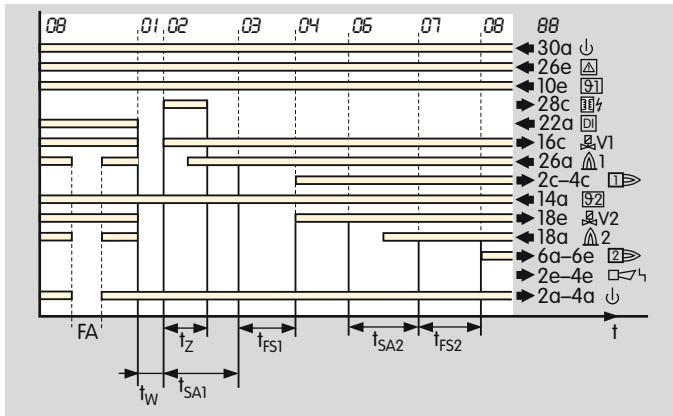

If the flame fails during high temperature operation, the ready contact opens for the duration of the flame failure (FA).

When High temperature mode is ended, the PFU switches off the burner and restarts with flame simulation check (recommended in the case of UV control with UVS).

Parameter 33 = 2

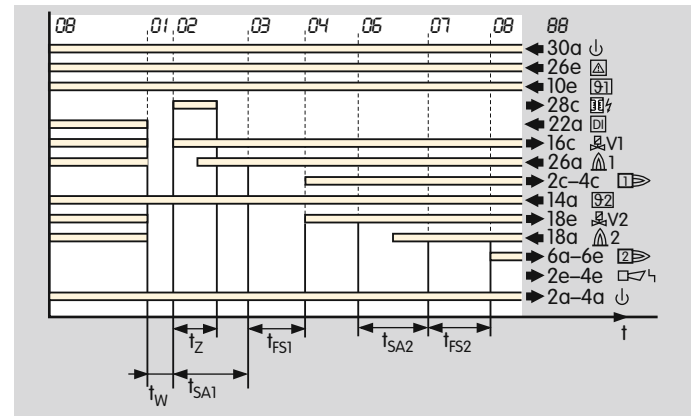

When High temperature mode is ended, the PFU switches off the burner and restarts with flame simulation check (recommended in the case of UV control with UVS).

Parameters

Parameter 33 = 3

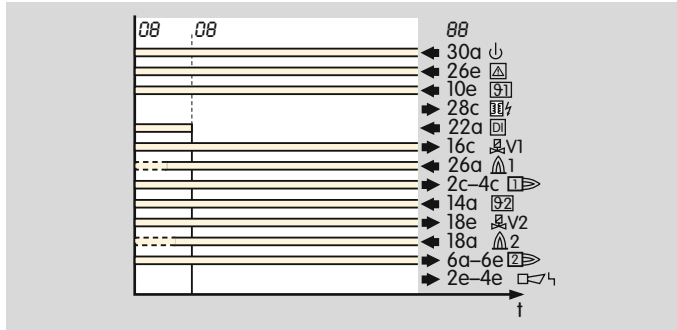

When High temperature mode is ended, the burner remains in operation and the PFU performs flame control again (recommended in the case of ionisation control or UV control with UVD).

If no flame signal is present when High temperature mode is ended, the burner control unit performs a fault lock-out, regardless of parameter 33.

Fault, pilot burner

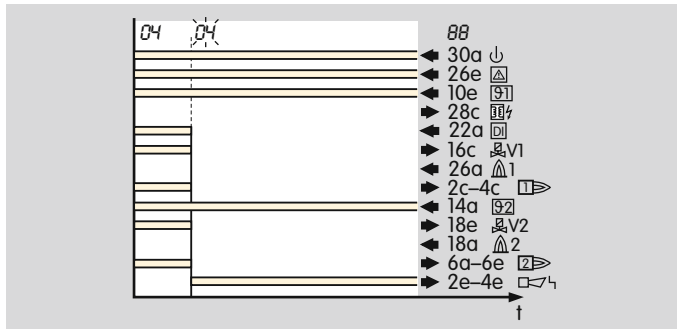

Fault, main burner

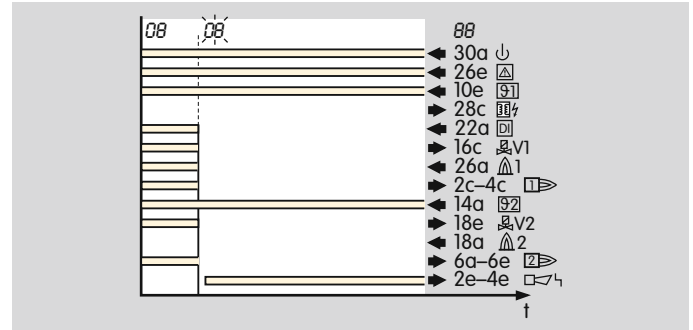

Parameter 33 = 4

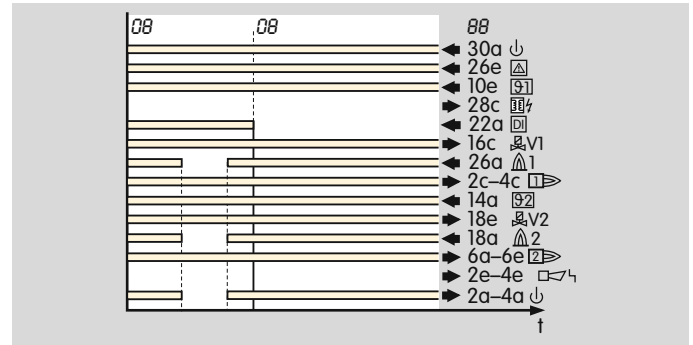

If the flame fails during high temperature operation, the ready contact is opened for the duration of the flame failure.

When High temperature mode is ended, the burner remains in operation and the PFU performs flame control again (recommended in the case of ionisation control or UV control with UVD).

4.2.6 UVS check

Parameter 35

An automatic restart of the burner control unit can be activated every 24 hours via this parameter. The time starts each time the start-up signal (9) is applied.

Parameter 35 = 0: Unlimited burner operation.

Parameter 35 = 1: An automatic restart is activated once every 24 hours.

It must be ensured in this case that the program sequence started matches the application. This parameter may be set in this way only if the burner can restart as intended in all operating phases.

4.3 Pilot and main burner monitoring

Burner control unit PFU 780 for pilot and main burner combination of unlimited capacity.

Pilot burner: single-stage-controlled.

Main burner: modulating or stage-controlled.

The burner control unit PFU 780 has separate start-up signal inputs for the pilot burner (terminal 10e) and the main burner (terminal 14a). The burner control unit coordinates the program run (the interplay) of both burners. If required, the main burner can be started once the pilot burner has reached its operating position. Benefit: The time for starting up the main burner can be reduced as low as its safety time. By using two flame amplifiers, the pilot and main burners can be monitored separately. The PFU 780 can also be used on indirectly ignited surface burners with end point monitoring.

Three different operating modes are possible:

Permanent pilot burner

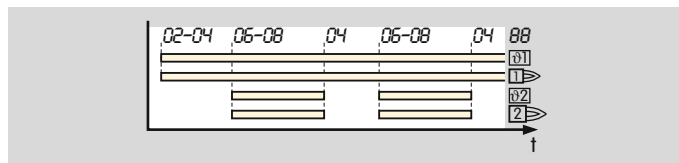

For applications which require a high system availability or where a continuously burning flame is necessary. The pilot burner is ignited once and remains constantly in operation. The main burner is controlled separately.

Intermittent pilot burner

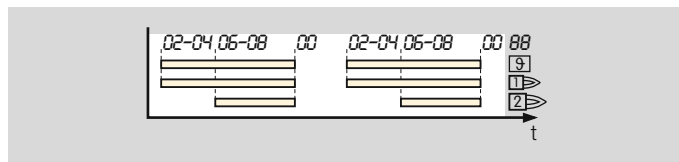

Pilot and main burners are controlled with one start-up signal (terminals 10e and 14a in parallel). The main burner starts automatically after the operating signal from the pilot burner has been detected. Operation is terminated simultaneously for both burners.

Interrupted pilot burner

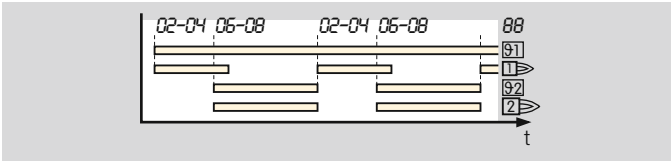

The pilot burner is switched off during the main burner safety time t_{SA2} . This type of flame control is required if no distinction can be made between the flame signals of the pilot and main burners (e.g. if both burners can be monitored with a single UV sensor). If the start-up signal for the pilot burner is applied continually, the pilot burner restarts immediately after the main burner has been switched off.

4.3.1 Permanent pilot burner

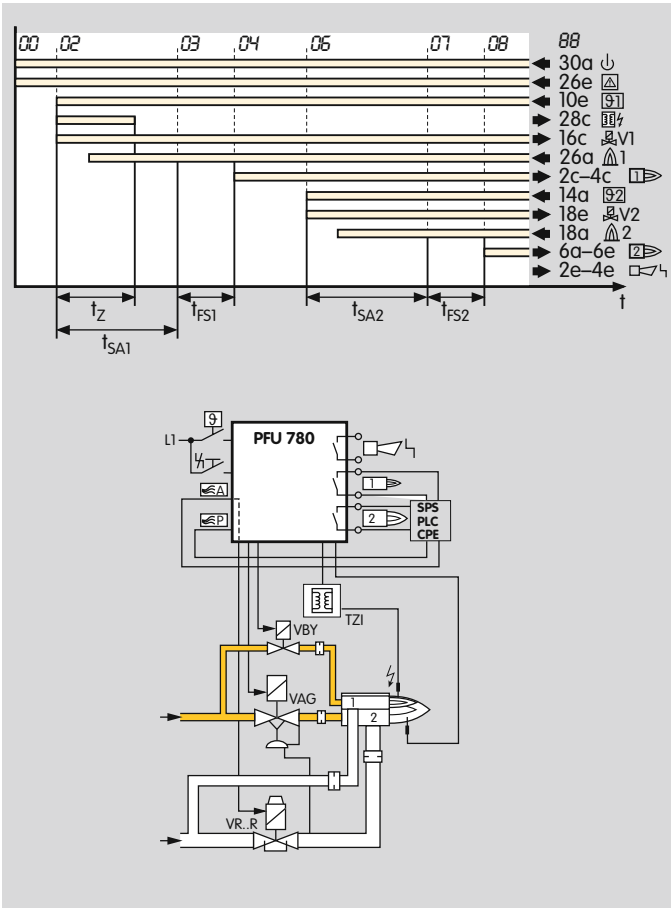

Parameter 16 = 1

Operating mode: Permanent pilot burner

In the “Permanent pilot burner” operating mode, the pilot burner remains in operation until its start-up signal drops.

If this parameter is activated (P16 = 1), both flames are controlled independently in the case of pilot and main burner monitoring.

Operating mode: Intermittent pilot burner

Start-up as in the illustration “Permanent pilot burner” with the difference being that the start-up signal for pilot and main burners is applied synchronously and that immediately after the flame proving period t_{FS1} , the main burner is started.

4.3.2 Interrupted pilot burner

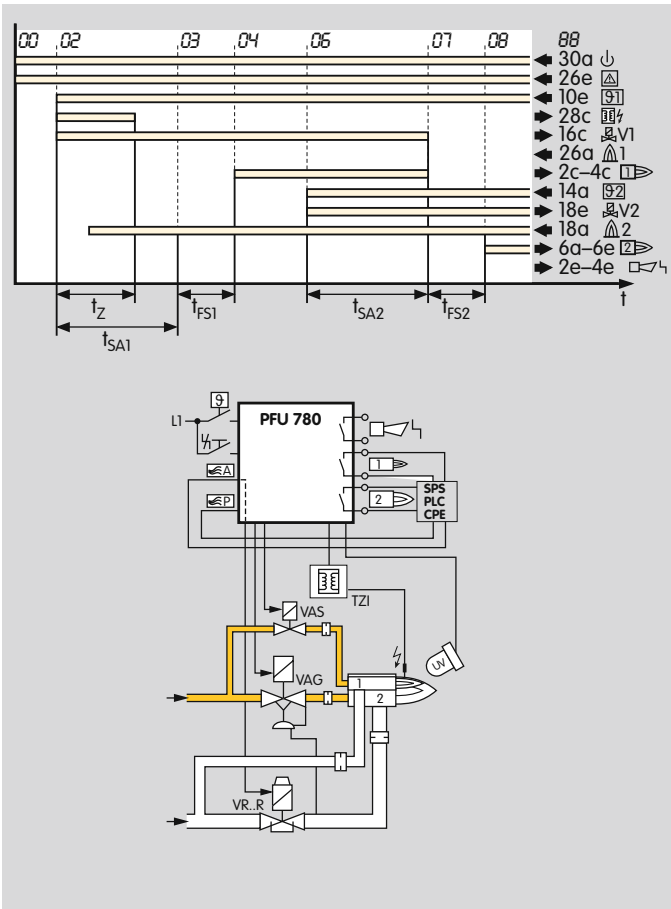

Parameter 16 = 0

Operating mode: Interrupted pilot burner

If parameter 16 = 0, the pilot burner is switched off once the safety time t_{SA2} has elapsed. In this setting, the flame signal can be connected to terminals 18a or 26a.

The pilot burner is switched off after the main burner safety time t_{SA2} has elapsed.

4.4 Behaviour in start-up position/standby

4.4.1 Flame simulation check in start-up position/standby

Parameter 15

This defines the instant for the flame simulation check.

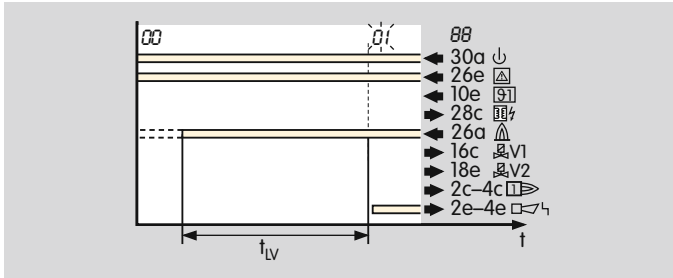

If the PFU notices an extraneous signal during the flame simulation check, it starts the flame simulation delay time t_{LV} (25 s). If the extraneous signal is discontinued during this period, the burner can start up. Otherwise, a fault lock-out occurs. $\square 1$ blinks on the display if an extraneous signal is detected by the pilot burner and $\square 5$ blinks if an extraneous signal is detected by the main burner.

Parameter 15 = 0: The flame simulation check is conducted after applying the start-up signal (9) during the waiting time t_W .

Parameter 15 = 1: The flame simulation check is conducted provided no start-up signal (9) is applied (during the so-called start-up position/standby). This allows fast start-up of the burner since there is no waiting time t_W .

The burner must have been switched off for at least 4 s before start-up in order for the flame simulation check to be conducted correctly.

Flame simulation check depending on parameter 16 (Pilot burner operating mode):

Parameter 15 = 1, Parameter 16 = 1

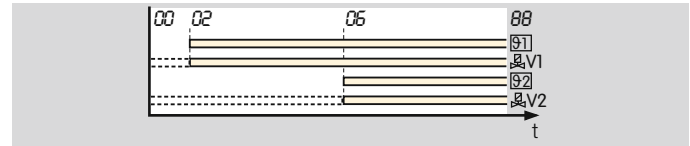

Parameter 15 = 0, Parameter 16 = 1

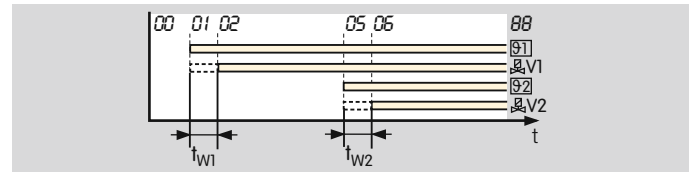

Parameter 15 = 1, Parameter 16 = 0

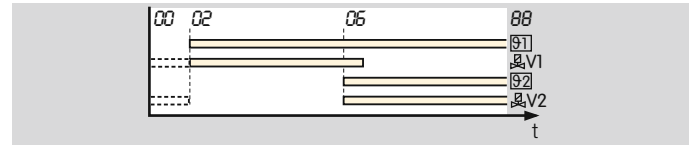

Parameter 15 = 0, Parameter 16 = 0

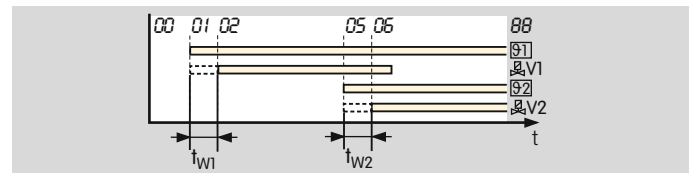

4.4.2 Minimum burner pause time t_{BP}

Parameter 21

Programmable time between 0 and 250 s.

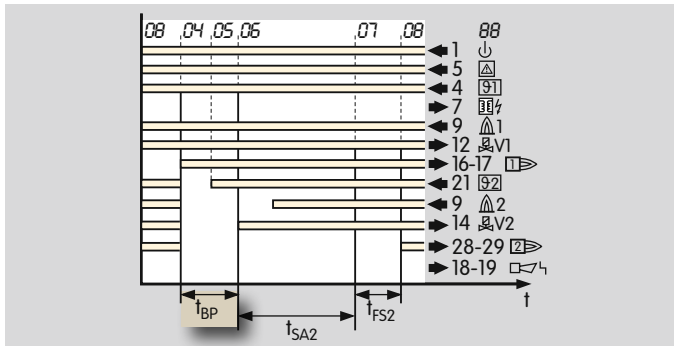

An immediate restart of the main burner after a normal shut-down, a start-up attempt, restart, cooling or purging is prevented by the pause time. The pause time starts when the air valve is switched off. If a start-up signal (92) is applied before expiry of this time, the start-up is delayed until the end of the pause time.

After the pause time, the burner is started if the start-up signal (9) is applied.

The minimum burner pause time t_{BP} serves to adapt the program sequence to the requirements of the application.

The time should be set such that the system can be moved to ignition position, i.e. butterfly valves can be closed and, possibly, gas can be flared off, before a re-start occurs.

See examples of application Stage-controlled main burner with alternating pilot burner and Stage-controlled main burner with permanent pilot burner.

The pause time has an effect on the behaviour of the main burner only. Background: The pilot burner is only used in single-stage operation.

4.5 Behaviour during start-up

4.5.1 Safety time on start-up t_{SA}

Pilot burner

Parameter 22

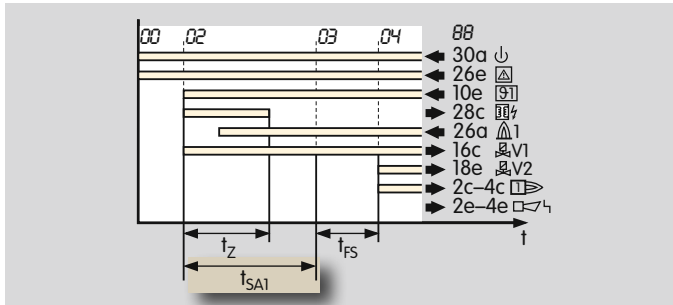

Safety time on start-up t_{SA1} for the pilot burner.

Main burner

Parameter 24

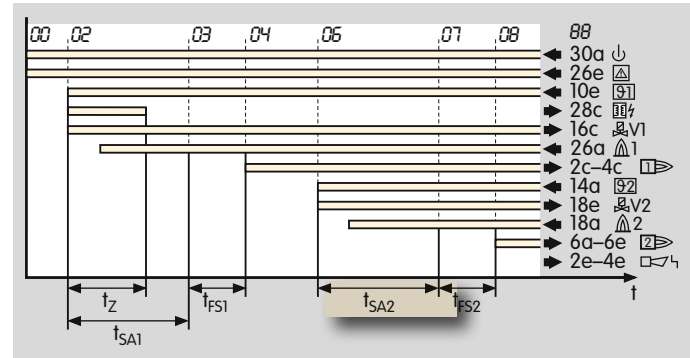

Safety time on start-up t_{SA2} for the main burner.

4.5.2 Flame proving period t_{FS}

Pilot burner

Parameter 23

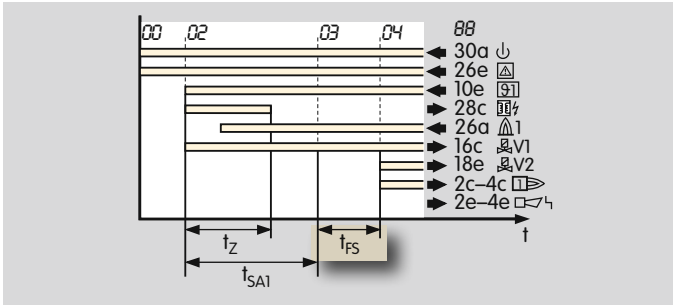

Main burner

Parameter 25

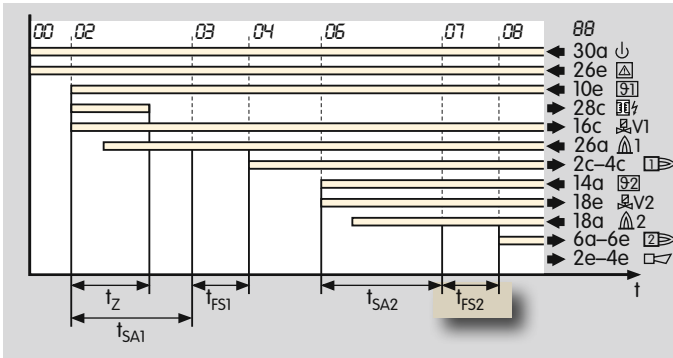

Programmable time between 0 and 25 s.

This time elapses before the PFU starts the next program step so as to give the flame time to stabilise.

4.5.3 Minimum combustion time t_B

Parameter 20

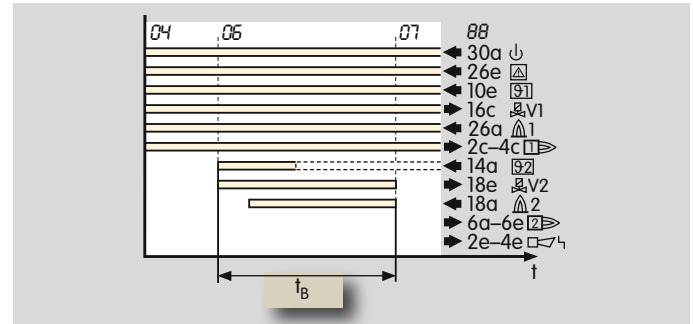

Programmable time to maximum 25 s during which the main burner remains in operation. In the case of brief activation of the start-up signal input (92) (e.g. with a pulse), the combustion time t_B is started, and the main burner remains in operation for at least this period.

4.5.4 Burner start-up attempts

Pilot burner

Parameter 10

This indicates the number of possible start-up attempts of the burner.

In accordance with EN 746-2, three start-ups are permitted in specific cases in the event of flame failure during start-up, if the safety of the installation is not impaired. Note the requirements of the Standards!

If no flame is detected during start-up, either a fault lock-out is performed or further start-up attempts in accordance with EN 746-2 occur.

Pursuant to NFPA 86, only one start-up attempt is permitted in the event of flame failure during start-up. For units approved by FM Approval (see type label), it is only possible to select one start-up attempt.

1 start-up attempt

Parameter 10 = 1

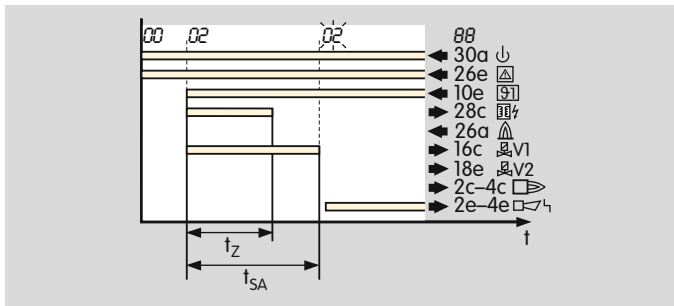

If no flame forms during start-up, a fault lock-out is performed after expiry of time t_{SA} . The display blinks and shows the cause of the fault.

2 or 3 start-up attempts

Parameter 10 = 2, 3

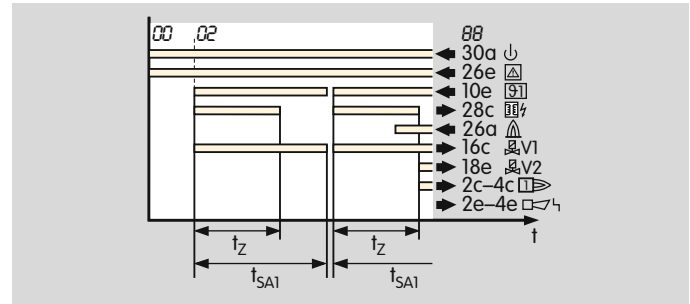

If several start-up attempts are set and if the PFU detects a flame failure during start-up, it closes valve V1 after the safety time t_{SA} has expired and attempts to start up again. After the last programmed start-up attempt has been completed, the burner control unit conducts a fault lock-out. The display blinks and shows the cause of the fault.

Main burner

Parameter 11

This indicates the number of possible start-up attempts of the main burner.

In accordance with EN 746-2, three start-ups are permitted in specific cases in the event of flame failure during start-up, if the safety of the installation is not impaired. Note the requirements of the Standards! If no flame is detected during start-up, either a fault lock-out is performed or further start-up attempts in accordance with EN 746-2 occur.

Pursuant to NFPA 86, only one start-up attempt is permitted in the event of flame failure during start-up. For units approved by FM Approval (see type label), it is only possible to select one start-up attempt.

1 start-up attempt

Parameter 11 = 1

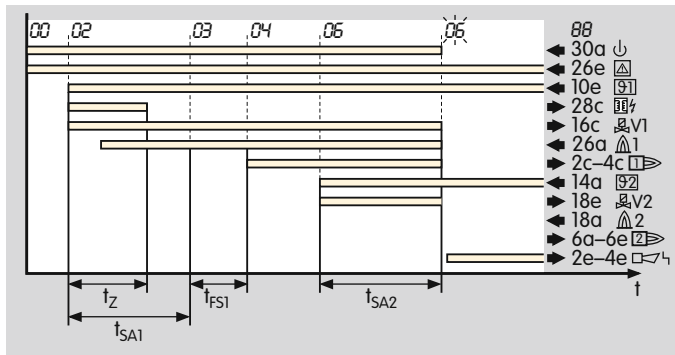

If no flame forms during the start-up of the main burner, a fault lock-out is performed after expiry of time t_{SA2} . The display blinks and shows the cause of the fault.

2 or 3 start-up attempts

Parameter 11 = 2, 3

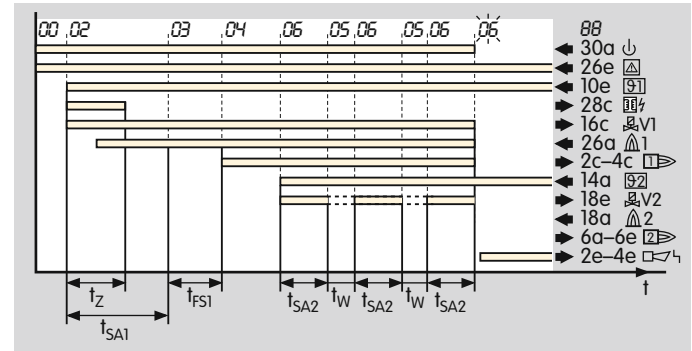

If several start-up attempts are set and if the PFU does not detect a flame signal during start-up, it closes valve V2 after the safety time t_{SA2} has expired and attempts to start up again. After the last programmed start-up attempt has been completed, the burner control unit conducts a fault lock-out. The display blinks and shows the cause of the fault.

4.6 Behaviour during operation

4.6.1 Safety time during operation t_{SB} for pilot and main burners

Parameter 14

This indicates the safety time during operation t_{SB} for valves V1 and V2. The default in accordance with EN 298 is 1 s. The PFU has also the available option of a safety time during operation t_{SB} of 2 s. Prolonging the time increases the installation availability in the case of brief-duration signal fades (e.g. fades of the flame signal). In accordance with EN 746-2, the safety time of the installation during operation (including closing time of the valves) may not exceed 3 seconds (note the requirements of the Standards).

4.6.2 Fault lock-out or restart, pilot burner

Parameter 12

This parameter determines whether the PFU starts a one-off restart or performs an immediate fault lock-out for the burner after an installation fault such as a flame failure or failure of air flow (see also Project planning information).

Immediate fault lock-out following flame failure

Parameter 12 = 0:

Pilot burner fault lock-out.

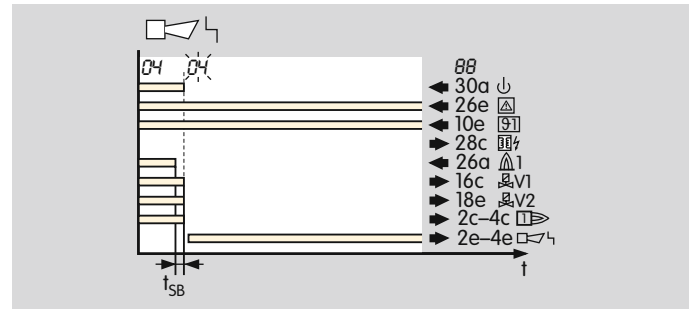

After a fault lock-out, the burner control unit can be reset, either with the button on the front panel or using an external button. Several burner control units can be reset in parallel using the external button.

The PFU cannot be reset by mains failure. The fault signalling contact does, however, open as soon as the mains voltage fails.

See also parameter 32, Behaviour of the air valve in the event of a fault lock-out.

Restart following flame failure

Parameter 12 = 1:

Restart following flame failure.

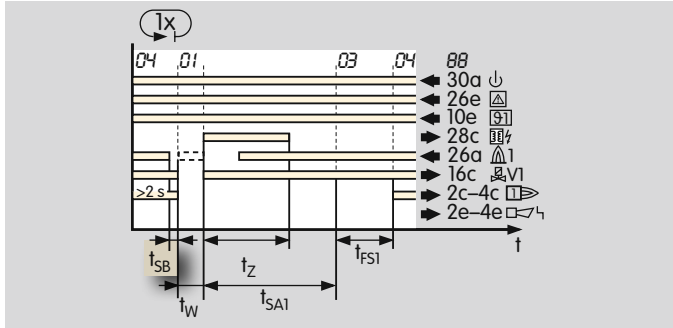

If the PFU detects a flame failure after a minimum operating time of 2 s, the valves are closed and the operation signalling contact is opened within time t_{SB} .

The burner control unit now attempts to restart the burner once. If the burner does not function, a fault lock-out occurs. The display blinks and shows the cause of the fault.

In accordance with EN 746-2, a restart may be conducted only if the safety of the installation is not impaired. Restart is recommended for burners which occasionally display unstable behaviour during operation.

The precondition for a restart is that activation of the restart allows the burner to restart as intended (in all operating phases). In this case, it must be ensured that the program sequence started by the PFU matches the application.

4.6.3 Fault lock-out or restart, main burner

This parameter determines whether the PFU starts a one-off restart or performs an immediate fault lock-out for the main burner after a flame failure (see also Project planning information).

Immediate fault lock-out following flame failure

Parameter 13 = 0:

Main burner fault lock-out

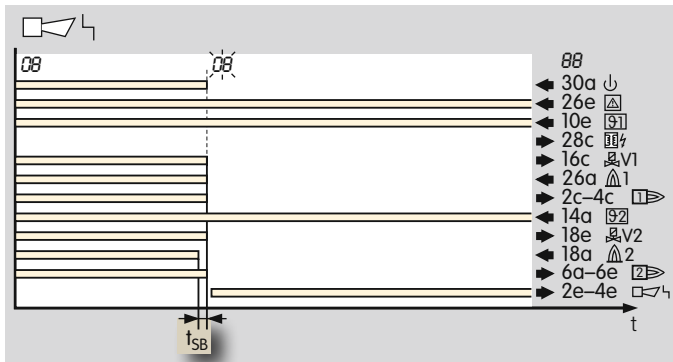

After a flame failure, the burner control unit performs a fault lock-out within the safety time during operation t_{SB} . This involves disconnecting the power from the gas valves and the ignition transformer. The fault signalling contact closes, the display blinks and shows the current program status (see table “Program status and fault messages”).

After a fault lock-out, the burner control unit can be reset, either with the button on the front panel or using an external button. Several burner control units can be reset in parallel using the external button.

The PFU cannot be reset by mains failure. The fault signalling contact does, however, open as soon as the mains voltage fails.

See also “Behaviour of the air valve in the event of a fault lock-out”.

Restart following flame failure

Parameter 13 = 1:

Restart following flame failure.

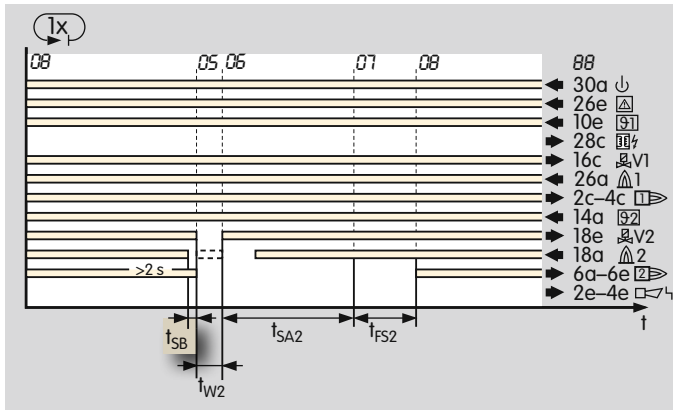

If the PFU detects a flame failure after a minimum operating time of 2 s, valve V2 is closed and the operation signalling contact is opened within time t_{SB} .

The burner control unit now attempts to restart the main burner once. If the burner does not function, a fault lock-out occurs. The display blinks and shows the cause of the fault.

In accordance with EN 746-2, a restart may be conducted only if the safety of the installation is not impaired. Restart is recommended for burners which occasionally display unstable behaviour during operation.

The precondition for a restart is that activation of the restart allows the burner to restart as intended (in all operating phases). In this case, it must be ensured that the program sequence started by the PFU matches the application.

4.7 Air valve control PFU..L

Parameter 30, Behaviour of the air valve during operation

Parameter 31, Behaviour of the air valve during start-up

Parameter 32, Behaviour of the air valve in the event of a fault lock-out

The PFU..L features an adjustable air valve control. The display shows that purging is currently being carried out with **PD**. **A** indicates that the air valve is being activated for cooling or heating.

The PFU..L supports the following functions:

- Purge
- Cooling in start-up position/standby
- Switching of the burner between low and high burner output during operation via the air valve
- To start up the burner as intended, external activation of the air valve can be blocked during start-up (prevents synchronisation problems between the PFU and the central control system)
- Controlling the air valve so that it
- opens with valve V2,
- opens once the main burner has reached its operating position
- Low fire over run time t_{KN} after a normal shut-down

4.7.1 Purge

Parameter 42 = 0: The air valve is closed when voltage is applied to terminal 30e.

Parameter 42 = 1: The air valve is opened when voltage is applied to terminal 30e.

In the case of multiple burner applications, burners with mechanical combustion air supply are used. The air for combustion and pre-purge is supplied by a central fan controlled by a separate logic. This logic determines the purging time.

The PFU..L supports centrally-controlled pre-purge or post-purge. The PFU..L is informed that purging is currently being performed by input 30e. It then opens the air valve, regardless of the status of the other inputs (purging has priority). The display indicates **PD**.

PFU 780..K2: For purging, the safety interlock (limits) must activate input 26e and input 30e of the PFU.

4.7.2 Cooling in start-up position/standby

The air valve can be activated externally via input 10a for cooling in the start-up position. During activation of the air valve the display shows **AD**, indicating that cooling is currently being carried out.

4.7.3 Burner start

Parameters 30 and 31 determine the behaviour of the air valve during burner start.

4.7.4 Airvalve opens in the case of external activation(not during start-up)

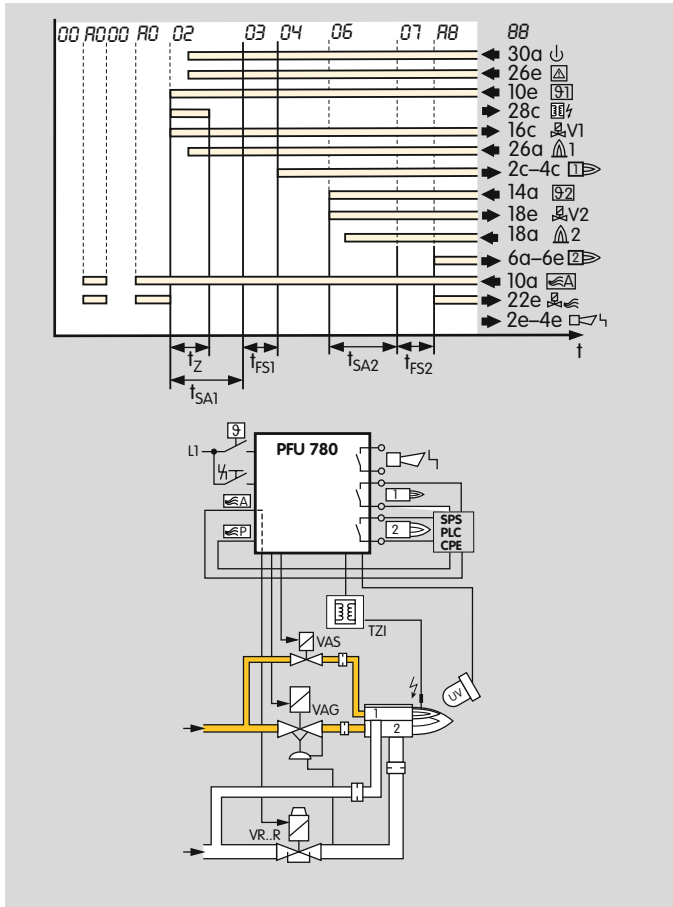

Parameter 30 = 0:

The air valve opens if it is activated externally by input 30e.

Parameter 31 = 0:

The air valve remains closed during start-up even if it is activated externally.

These settings are required on burners on which the gas/air ratio is controlled via a pneumatic link and which also need to be started at low fire, e.g. on two-stage-controlled burners. In this case, activation of the air valve during burner start via input 10a must be prevented.

External control allows switchover between low fire and high fire during operation.

The air valve can be activated externally via input 10a for cooling the burner in the start-up position/standby.

4.7.5 Air valve opens in the case of external activation (even during start-up)

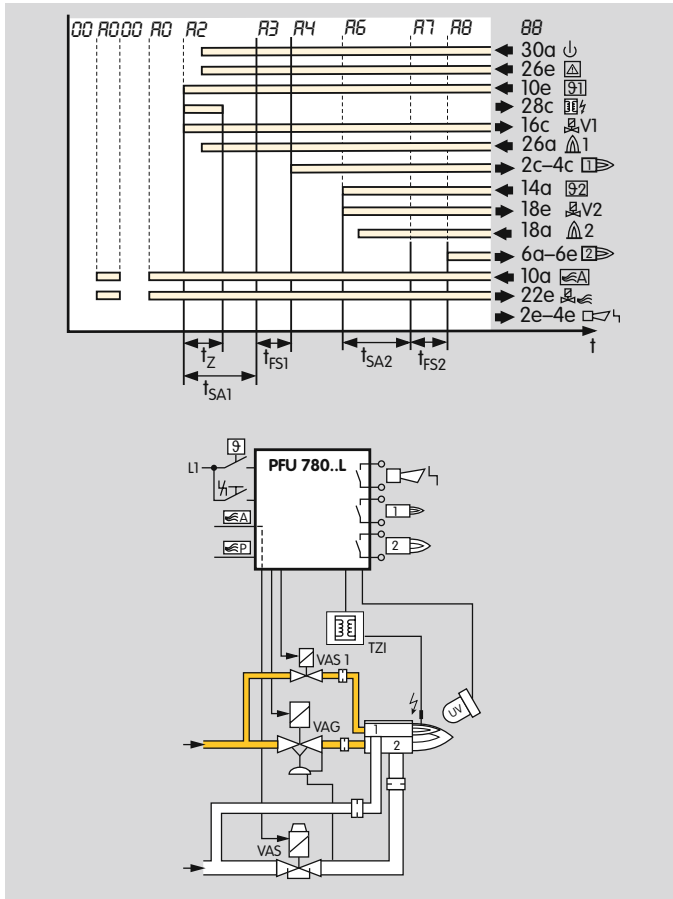

Parameter 30 = 0:

The air valve opens if it is activated externally via input 10a.

Parameter 31 = 1:

The air valve can be activated even during start-up.

These settings may be selected only if the burner can start with full air capacity.

The air valve can be activated externally via input 10a for cooling the burner in the start-up position/standby.

4.7.6 Air valve opens with valve V2

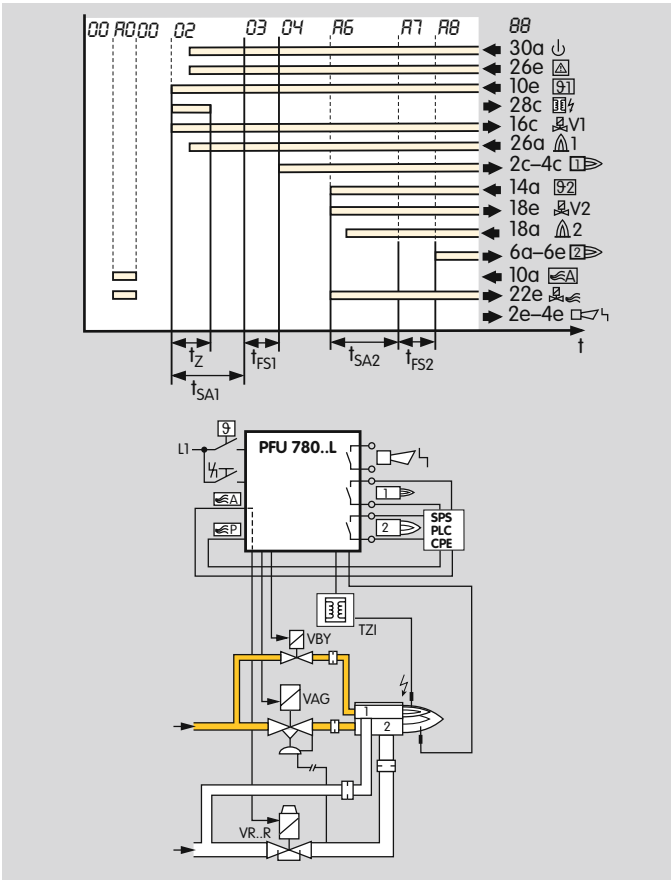

Parameter 30 = 2:

The air valve opens simultaneously with valve V2.

Application:

Single-stage-controlled main burner is switched ON/OFF via the 9 input.

The air valve can be activated externally via input 10a for cooling the burner in the start-up position/standby.

4.7.7 Air valve opens with operating signal

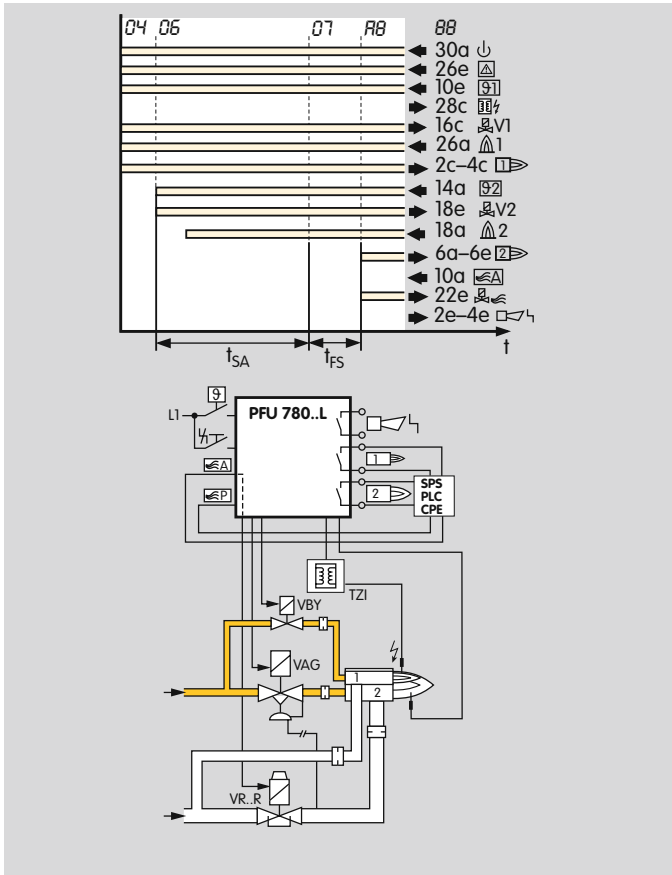

Parameter 30 = 3:

The air valve opens simultaneously with the operating signal.

Application:

Two-stage-controlled main burner is switched ON/OFF via the 9 input.

The air valve can be activated externally via input 10a for cooling the burner in the start-up position/standby.

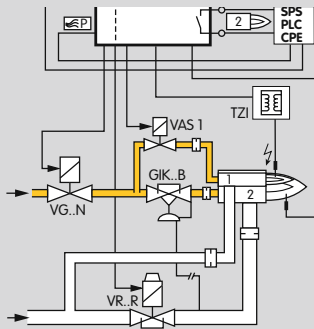
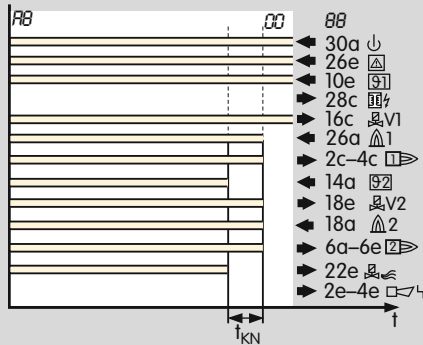
4.7.8 Low fire over run time t_{KN} after a normal shut-down

Parameter 36

Settings: 0; 3; 5; 10; 15; 25 or 60 (low fire over run time in seconds)

This parameter is applicable to systems with a pneumatic link between gas and air and On/Off control.

Parameter 36 = 0 (low fire over run time $t_{KN} = 0$ s):
Without low fire over run, the gas side is closed immediately owing to the quick-closing gas valve in the case of On/Off control. The air side closes more slowly. The air flowing in during the closing time increases the O_2 content in the combustion chamber.

Parameter 36 = 3; 5; 10; 15; 25 or 60 (low fire over run time $t_{KN} = 3, 5, 10, 15, 25$ or 60 s):

The air valve closes slowly after the activation signal has been switched off. The gas valve remains open for t_{KN} . This means that the burner, after deactivation of the main burner start-up signal ($\text{Ø}2$), is initially adjusted down to low fire and then switched off completely.

Using the low fire over run function reduces the O_2 content in the furnace atmosphere.

Flame control is still operational. Can be used only in the case of pneumatic link and On/Off control. It must be ensured that no excess gas occurs.

The low fire over run time has an effect on the behaviour of the main burner only.

Background: The pilot burner is only used in single-stage operation.

4.7.9 Behaviour of the air valve in the event of a fault lock-out

Parameter 32:

This determines whether the air valve can be activated in the case of a fault lock-out.

Parameter 32 = 0:

The air valve is closed in the event of a fault. It cannot be activated externally via terminal 10a.

Parameter 32 = 1:

The air valve can be activated externally via input 10a even during a fault, e.g. for cooling.

4.8 Manual operation

For convenient setting of the burner or analysing faults.

The parameter display is not available in Manual mode. Manual mode can be accessed only if the unit was not in Fault state before switching off. The following times/functions are not active in Manual mode: start-up attempts, restart, minimum combustion time and cycle lock.

If the Reset/Information button is pressed for 2 s during switch-on, the PFU reverts to Manual mode. Two dots blink on the display.

In this operating mode, the burner control unit operates independently of the status of the inputs (apart from the pre-purge input and the safety interlocks. These are of higher priority and will be processed first).

Each time after the button is pressed again, the PFU moves to the next section of the program sequence and stops there. After approx. 3 s, the flame signal will be displayed instead of the program parameter. Briefly pressing the Reset/Information button (< 1 s) displays the relevant Manual mode step. If there is flame simulation during the start-up, the flame signal is displayed immediately.

On units with air valve control, the air valve can be opened and closed repeatedly by pressing the button during operation.

Manual mode can be terminated by switching off the PFU (On/Off button).

4.8.1 Manual mode limited to 5 minutes

Parameter 34:

Parameter 34 determines when Manual mode is terminated.

Parameter 34 = 0:

Manual mode is not limited in time. If this function has been selected, operation of the furnace may be continued manually in the event of failure of the central control system.

Parameter 34 = 1:

Manual mode ends automatically five minutes after the last time the button was pressed. The PFU then moves abruptly back to start-up position/standby.

4.9 Password

Parameter 50:

(Four-digit) password saved to protect parameter settings. To prevent unauthorised changes to parameter settings, a password is stored in parameter 50. Changes to parameter settings can only be made once this number has been entered. The password can be changed using BCSoft.

Note the effect of parameter settings on the safe functioning of your system.

The password set at the factory can be found in the delivery note supplied.

5 Selection

5.1 Calculating the safety time t_{SA}

Sicherheitszeit im Anlauf
 t_{SA} nach EN 746-2



D ▼

Brennerart
Brenner mit Zwangsluft, direkt gezündet ▼

Hauptbrennerleistung PN kW

Hauptbrenner Sicherheitszeit s

 Edition 02.12 

5.2 Selection table

Type	L	T	N	D*	U*	K2*
PFU 780	●	●	●	○	○	○

* If "none", this specification is omitted.

● = standard, ○ = available

Order example

PFU 780LT

5.2.1 Type code

Code	Description
L	Air valve control
T	Mains voltage
N	220 – 240 V~, -15/+10 %, 50/60 Hz 110 – 120 V~, -15/+10 %, 50/60 Hz
D*	Digital input to interrupt flame control
U*	Preparation for UV sensor for continuous operation UVD 1
K2*	Compatible with PFU 798

* If "none", this specification is omitted.

6 Project planning information

6.1 Cable selection

Use mains cable suitable for the type of operation and complying with local regulations. Do not route PFU cables in the same cable duct as frequency converter cables or cables emitting strong fields.

6.1.1 Ignition cable

Use unscreened high-voltage cable, see page 56 (Accessories). Cable length: max. 5 m, recommended < 1 m. Screw the ignition cable securely into the ignition transformer and run to the burner by the shortest possible route.

The longer the ignition cable, the lower the ignition capacity. Only use radio interference suppressed electrode adapters (with 1 k Ω resistor) for ignition electrodes, see see page 56 (Accessories) . Do not lay UV/ionisation cable and ignition cables together and lay them as far apart as possible.

6.1.2 Ionisation cable

Use unscreened high-voltage cable, see page 56 (Accessories) . Cable length: max. 100 m. Avoid external electrical interference. Install as far as possible from mains and ignition cables and interference from electro-magnetic sources. If possible, do not lay in a metal conduit. Several ionisation cables can be routed together.

6.1.3 UV-Leitung

Cable length: max. 100 m. Avoid external electrical interference. Install as far as possible from mains and ignition cables and interference from electro-magnetic sources. If possible, do not lay in a metal conduit. Several UV cables can be routed together.

6.2 Ignition electrode

6.2.1 Electrode gap

Gap between electrode and burner earth:
2 mm \pm 0.5 mm.

6.2.2 Star electrodes

We recommend using 7.5 kV ignition transformers on burners with star electrodes.

6.3 Minimum combustion time

Even if the start-up signal (ϑ) is applied only briefly, the time set under parameter 20 elapses before the burner control unit shuts down the burner or signals a fault. To stabilise the burner operation, a minimum combustion time can be set independently of the central control system. If the start-up signal (ϑ) drops once the second safety time t_{SA2} has started to elapse, the burner remains in operation for at least time t_B . The minimum combustion time t_B starts to elapse following controller enable. If the start-up signal drops before the second safety time t_{SA2} , e.g. during pre-purge, the control unit reverts directly to standby and the burner is not ignited. The signal inputs for the pilot/main burner start-up signal cannot be used for a safety shut-down because the unit controls the valves until the minimum combustion time has elapsed.

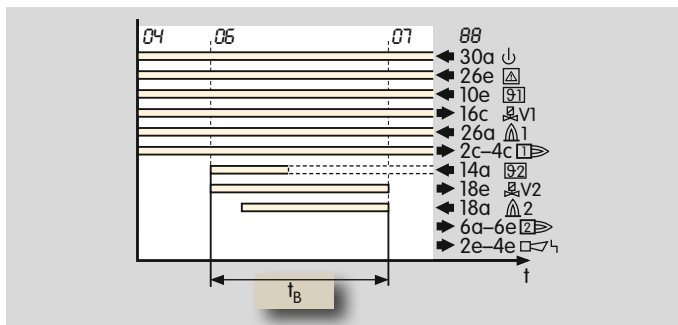

In the case of pilot/main burner monitoring, the minimum combustion time only has an effect on the be-

haviour of the main burner. The minimum combustion time for the pilot burner is limited to the safety time on start-up (t_{SA1}).

Background: The pilot burner is only used in single-stage operation.

6.4 Safety interlocks (Limits)

The limiters in the safety interlock (linking of all the relevant safety control and switching equipment for the use of the application, e.g. safety temperature limiter, minimum and maximum gas pressure, tightness control) must isolate terminal 26e from the voltage supply. If the safety interlock is interrupted, this is indicated by a blinking **[5]** on the display.

If the safety interlocks fail, an immediate program abort with switch-off of all outputs occurs (even during the safety time). If the safety interlocks are operational again or the unit is switched back on, the program run is restarted in standby.

6.5 Emergency stop

6.5.1 In the event of fire or electric shock

If there is a risk of fire, electric shock or similar, inputs L1, N and 26e (safety interlocks) of the PFU should be disconnected from the electrical power supply – this should be reflected in the wiring on site.

6.5.2 Via the safety interlocks (limits)

The safety interlock turns off the power to input 26e, such as in the event of air deficiency or similar.

6.6 Reset

6.6.1 Parallel reset

Several burner control units can be reset in parallel using the external button. The PFU cannot be reset by mains failure.

6.6.2 Permanent remote reset

Permanent remote reset gives rise to a malfunction. If a remote reset signal is permanently applied to terminals 10c/12c,  flashes on the display to indicate a fault.

Reset with a pulse < 1 s.

6.6.3 Automatic remote reset (PLC)

In the case of automatic remote reset (PLC), the reset pulse duration should not exceed 1 second. Check compliance with standards.

If a fault is acknowledged by remote reset too often, error  (Too many remote resets) is displayed. The error

can only be acknowledged with the Reset/Information button on the unit.

The burner malfunction must be remedied. The malfunction can not be remedied by changing the method of activation.

6.6.4 Burner start

A furnace start may only be initiated, if it has been ensured using an appropriate procedure that there is no combustible mixture in the combustion/processing chamber, in the connected areas or in the exhaust gas system (heat exchanger, dust collector). This can be achieved by pre-purge, which occurs immediately before ignition or within the period specified in the operating instructions.

In the case of multiple burner applications, pre-purge is not necessary after a normal burner shut-down.

Note the requirements of the Standards. For exceptions, see Standards.

6.6.5 Restart and start-up attempts

The precondition for a restart/start-up attempt is that activation of the restart allows the burner to restart as intended (in all operating phases). In this case, it must be ensured that the program sequence started by the PFU matches the application.

Note the requirements of the Standards. For exceptions, see Standards.

6.7 Fault message

The fault signalling contact opens, as soon as the mains voltage fails.

6.8 Protecting the pilot burner from overload

To protect the unit against overload by frequent cycling, the maximum number of start-ups per minute is limited for the PFU. Excessive cycling triggers a fault message (blinking ). The max. number of start-ups per minute depends on the safety time t_{SA} :

t_{SA} [s]	Ignition transformer TZI	Max. start-ups/min.
3	5-15/100	6
5	5-15/100	5
10	5-15/100	4

6.9 Installation

Installation position: any.

Installation in 19" module subracks only, see page 57 (Socket connectors)

Install in clean environment ensuring enclosure IP 54 or higher, whereby no condensation is permitted.

Cable length between PFU and burner: max. 100 m.

6.10 Wiring

The PFU is suitable for hard wiring only. Do not reverse phase and neutral conductor. Different phases of a three-phase current system must not be installed at the PFU. No voltage may be connected to the valve and ignition outputs.

6.10.1 UVS sensor wiring

Connect the UVS sensor directly to the PFU. Operating the sensor with incorrect polarity or voltage can lead to destruction of the sensor.

6.11 PFU switched off

The PFU cannot be activated when no mains voltage is applied or when it is switched off. The fault signalling contact is only closed when the unit is supplied with voltage and switched on.

If the unit is switched off, an immediate program abort with switch-off of all outputs occurs (even during the safety time). When the unit is switched on, the program run is restarted in standby.

6.12 Furnace control

Switch on the system to start up the furnace, then release the burner start via the safety interlocks and afterwards start the burner control so that the burner control unit may monitor the burners as intended. To shut down the furnace, first disconnect the burner control unit from the temperature control (burner ON signal), then disconnect the safety interlocks and finally switch off the system.

6.13 Note on EC type-examination

Since EN 298 (1993) does not describe all functions of the PFU, the operator is responsible for ensuring that all parameters and functions are matched to the respective application.

6.14 Mains switch

The mains switch in the unit isolates the PFU on two poles from the mains. It does not meet the requirements of EN 50156-1:2004 (5.2.2 Switch disconnectors) set out in chapter 5 for a device to disconnect the power supply. Although the mains switch cannot be used for disconnecting from the electrical power supply in accordance with EN 50156, it does allow the burner to be isolated functionally from the central control system. This function is required for manual operation and, in the case of PROFIBUS units, to switch off the unit without causing BUS errors. Disconnection for electrical maintenance work is to be implemented with an ex-

ternal switch per unit or group only, in accordance with Standard “EN 50156”.

6.15 Changing parameters

In certain cases, it may be necessary to change the default settings. Using a separate software package and a PC opto-adapter, it is possible to modify certain parameters on the PFU, such as the switch-off threshold of the flame amplifier, the behaviour in the event of a flame failure or if the pilot burner is to burn permanently in the case of pilot and main burner monitoring.

The software package with PC opto-adapter, as well as “Changed parameters” stickers, are available as accessories – see section entitled page 56 (Accessories).

The unit parameters set at the factory are specified in the delivery note.

Document changed parameters in BCSoft using the protocol function and enclose the protocol with the plant documentation.

If a replacement is ordered for a PFU with changed parameters, refer to the protocol for details.

7 Flame control

7.1 With ionisation sensor

The PFU generates an alternating voltage (230 V AC) between the sensing electrode and burner earth. The flame rectifies this voltage. Only the DC signal (depending on the switch-off threshold for the pilot and main burners) is recognised by the burner control unit as a flame signal.

A flame cannot be simulated. Ignition and monitoring with a single electrode is possible.

7.2 With UV sensor

A UV tube inside the UV sensor detects the ultraviolet light of a flame. It does not respond to sunlight, incandescent bulb light or infrared radiation emitted by hot workpieces or red-hot furnace walls.

In the event of incident UV radiation the UV sensor rectifies the supplied alternating voltage. As with ionisation control, the burner control unit only detects this DC signal.

When using UV sensors of Type UVS, the burner control unit may be used for intermittent operation only. This means that operation must be interrupted at least once every 24 hours. This can be programmed using parameter 35.

For further information, see brochure UVS.

The burner control unit PFU..U is prepared for UV sensor UVD 1. This enables continuous operation. For further information, see Technical Information Bulletin UVD.

7.3 Via the temperature in high temperature equipment

High temperature equipment is defined as a thermo-processing installation, in which the wall temperature of the combustion chamber and/or the processing chamber exceeds 750°C. Burner control unit PFU..D features a special “High temperature operation” function. During heating up, standard monitoring methods (ionisation or UV) must be used for flame control. When the working temperature has exceeded 750°C, indirect flame control can be taken over by a central monitoring device. When the DI input (terminal 22a) is activated, the burner control unit reverts to this operating mode.

Important: In “High temperature operation”, i.e. with the DI input being activated, burner control unit PFU..D does not evaluate the flame signal. The safety function of the burner control unit’s flame control is deactivated during this operating phase.

8 Accessories

8.1 High-voltage cable

FZLSi 1/7 up to 180°C, Order No.: 04250410.

FZLK 1/7 up to 80°C, Order No.: 04250409.

8.2 BCSoft

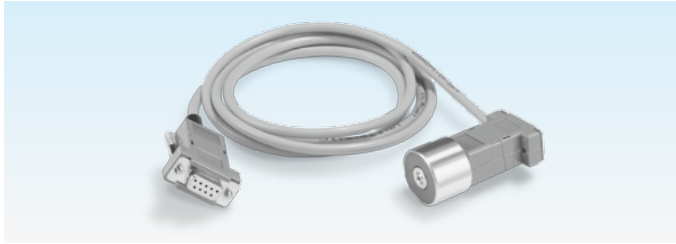

Opto-adaptor including BCSoft CD-ROM,
Order No.: 74960437.

The current software can be downloaded from our Internet site at <http://www.docuthek.com>. To do so, you need to register in the DOCUTHEK.

8.3 Stickers for labelling



For printing with laser printers, plotters or engraving machines, 27 × 18 mm or 28 × 17.5 mm.

Colour: silver

8.4 “Changed parameters” stickers

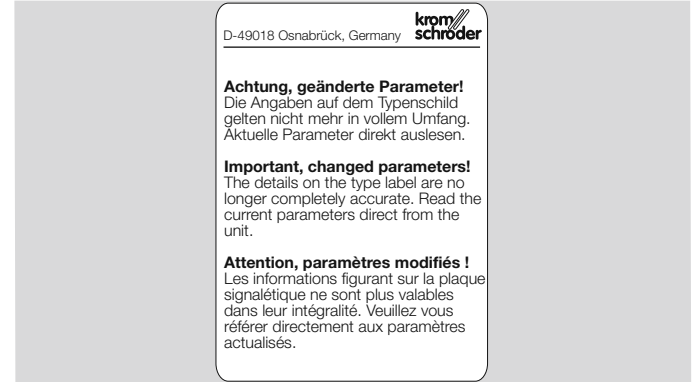

Affix on the connection diagram of the PFU following changes to unit parameters set at the factory.
100 pcs, Order No.: 74921492.

8.5 Radio interference suppressed electrode adapters

Plug cap, 4 mm, interference-suppressed,
Order No. 04115308.

Straight adapter, 6 mm, interference-suppressed,
Order No. 04115306.

8.6 Socket connectors

Type	Order No.
Socket connector E, 48-pin solder tag connection	04120148
Socket connector E, 48-pin wire-wrap connection	04120158

8.7 Module subrack

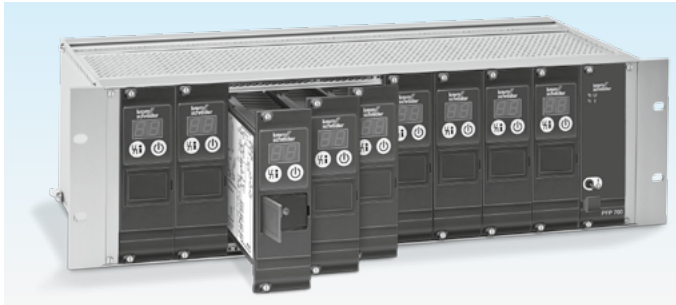

Module subrack BGT S-9U/1 for PFP 700, PFU 780

comprising:

module subrack, printed-circuit board with rear terminal strip, function-tested, standard documentation, guide rails, without partial front plates, screw terminals at the rear.

Slots 1 – 9 for PFU 760/780, slot 10 for PFP 700,
Order No. 84402281

Module subrack BGT SM-8/1/1 for MPT 700, PFU 780

comprising:

module subrack, printed-circuit board with rear terminal strip, function-tested, standard documentation, guide rails, without partial front plates, screw terminals at the rear, single-zone operation for MPT 700 operating modes 1 – 4, two-zone operation for MPT 700 operating modes 1 – 4, but max. 4 burners per zone.

Slot 1 for MPT 700, slots 2 – 9 for PFU 760/780, slot 10 for PFP 700

Order No. 84402282 (no illustration provided)

Module subrack BGT SA for PFA 700/PFU 760 and PFA 710/PFU 780

consisting of:

odule subrack, printed-circuit board with rear terminal strip, function-tested, standard documentation, guide rails, without partial front plates, screw terminals at the rear, relays and screw terminals for four free inputs and four free outputs, connection to PROFIBUS DP with D-Sub socket.

BGT SA-9: slot 1 for PFA 700, slots 2-10 for PFU 760,
BGT SA-8: slot 1 for PFA 710, slots 2-9 for PFU 780

Order no.

BGT SA-9U/1 DP700: 84402291

BGT SA-8U/1 DP710: 84402292 (no illustration provided)

8.8 Power supply PFP 700

For supplying the control inputs of burner control unit PFU or for supplying the auxiliary voltage to relay module PFR 704. Operating status display on the front plate. PFP switches off in the event of an output overload. Output voltage 24 V, output rating 14 VA.

Order No. 84366510

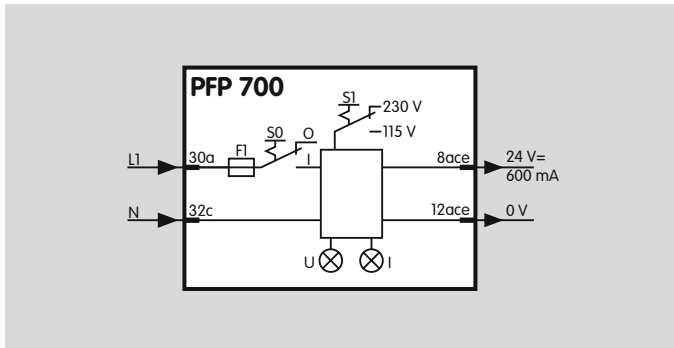



8.9 Relay module PFR 704

For contact multiplication, e.g. if several air valves are activated via a single control signal for pre-purge, or for heating/cooling switchover when using an MPT. Switching status display on the front plate.

Input voltage:

110/120 V AC, -15/+10%, 50/60 Hz,
 220/240 V AC, -15/+10%, 50/60 Hz,
 24 V AC/DC, ± 10%.

Current per relay: 25 mA.

Contact rating of floating outputs: max. 2 A, 264 V (not fused internally).

Order No. 84373510

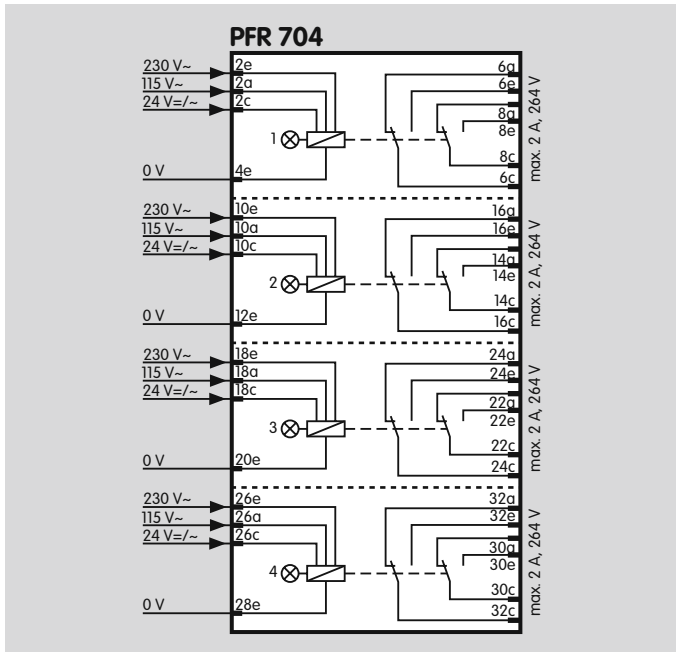



8.10 Field bus interface PFA 700

For connection of up to nine automatic burner control units PFU 760 to industrial communication networks using PROFIBUS-DP, in order to transfer measuring, control and regulation signals as a bundle.

4 digital inputs: 24 V DC, $\pm 10\%$, < 10 mA,

4 digital outputs: relay contact, max. 1 A, 264 V (not fused internally).

Mains voltage: 110 – 240 V AC, $-15/+10\%$, 50/60 Hz.

Further information can be found in Technical information PFA.

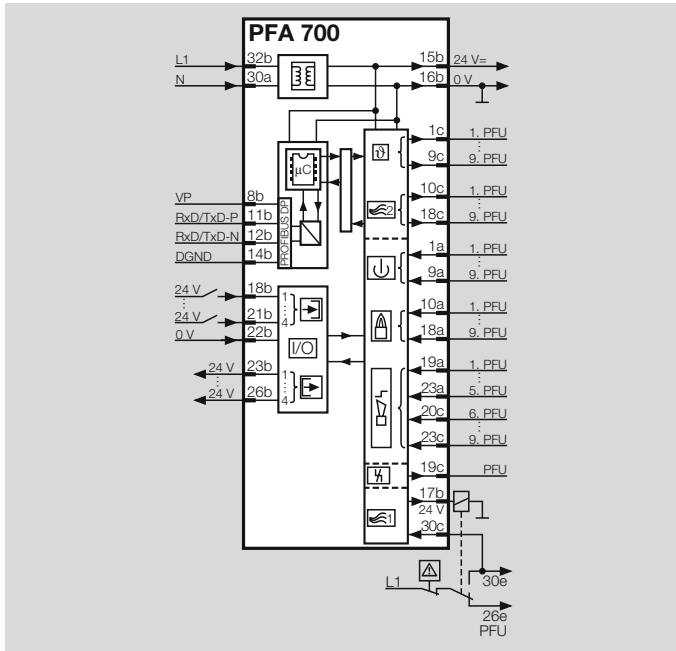

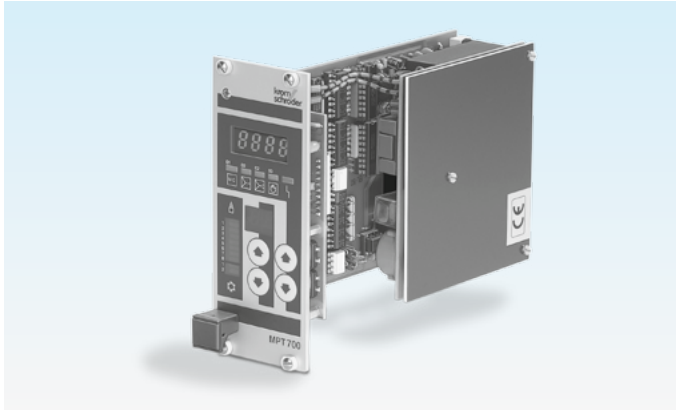

8.11 Impulse system MPT 700

With 11 outputs for activation of burner control units PFU 780. The furnace atmosphere is circulated thanks to intermittent operation, and thereby constant temperature distribution and shorter heating-up periods for all gas-fired heat treatment furnaces are ensured.

Mains voltage: 95–240 V AC, $\pm 10\%$, 50/60 Hz.

Power consumption: 10 VA.

Additional auxiliary voltage:

12–24 V DC, $\pm 10\%$, max. 1.1 A.

Controller inputs: 2 x 0(4)–20 mA with common earth, floating, load impedance approx. 225 Ω .

Three-point step input: floating, 12–24 V DC, load impedance approx. 2.7 k Ω .

Digital inputs E1–E3: with common earth, floating, 12–24 V DC, load impedance approx. 2.7 k Ω .

Order No. 84395050

Further information can be found in brochure MPT.

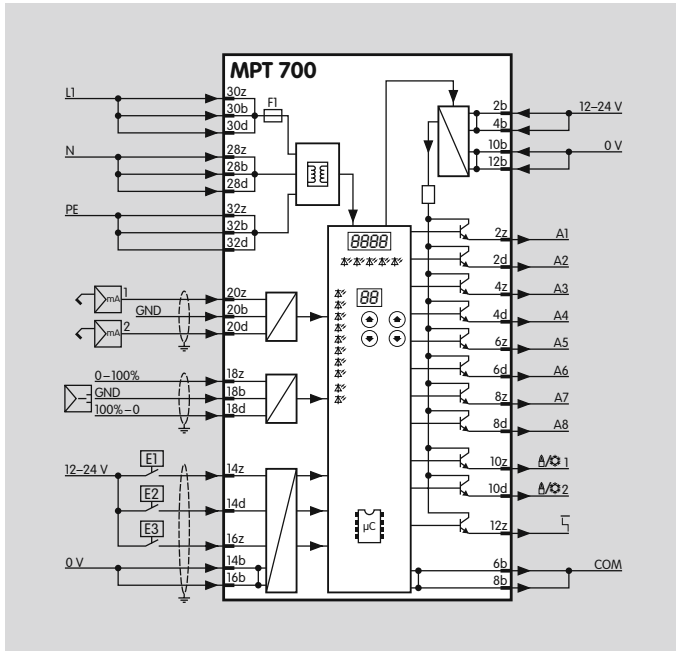

9 Technical data

Mains voltage:

220/240 V AC, -15/+10%, 50/60 Hz or

110/120 V AC, -15/+10%, 50/60 Hz,

for grounded and ungrounded mains.

Power consumption: < 8 VA.

Control inputs:

Input voltage/current:

Pilot burner, main burner, air valve, multi-flame control and remote reset:

24 V DC, $\pm 10\%$, < 7 mA per input.

Input voltage for safety interlocks, digital input DI and purge = mains voltage.

Input voltage of signal inputs:

Rated value	110/120 V AC	220/240 V AC
Signal "1"	80 – 132 V	160 – 264 V
Signal "0"	0 – 20 V	0 – 40 V
Frequenz	50/60 Hz	50/60 Hz

Rated value	24 V DC
Signal "1"	24 V, $\pm 10\%$
Signal "0"	< 1 V

Inherent current:

Signal "1"	typ. 5 mA
------------	-----------

Output voltage for voltage-related outputs = mains voltage.

Contact rating		
Gas valve V1, V2	Max. 1 A resistive	Max. 1 A $\cos \varphi$ 0.3
Air valve	Max. 1 A resistive	Max. 1 A $\cos \varphi$ 0.3
Ignition	Max. 1 A resistive	Max. 1 A $\cos \varphi$ 0.3
Number of operating cycles	Max. 1,000,000, typically 400,000	Max. 250,000, typically 100,000

Output current: max. 2 A per output, but total current for valves and ignition transformer max. 2.5 A.

Operation and fault signalling contacts:

dry contact (floating), max. 1 A, 24 V, not fused internally.

Number of operating cycles:

Mains switch: 1000,

Reset/Information button: 1000.

Technical data

Flame control:

Sensor voltage: approx. 230 V AC.

Sensor current: > 1 μ A,

Length of sensor cable: max. 100 m.

Fuse in unit:

F1: 3.15 A, slow-acting, H pursuant to IEC 127-2/5,

F2: 3.15 A, slow-acting, H pursuant to IEC 127-2/5.

Ambient temperature:

-20 to +60 °C (-4 to +60.00 °C),

Climate: no condensation permitted.

Enclosure: IP 00 pursuant to IEC 529,

after installing in a 19" module subrack according to the instructions, e.g. type BGT, the front corresponds to IP 20.

Input/Output safety circuit:

All the inputs and outputs marked "■" (see connection diagrams) may be used for safety tasks.

Weight: approx. 650 g (23 oz.).

9.1 Safety-specific characteristic values

In the case of ionization control, suitable for Safety Integrity Level	SIL 3
Diagnostic coverage DC	97.9%
Type of subsystem	Type B to EN 61508-2, 7.4.3.1.4
Mode of operation	High demand mode pursuant to EN 61508-4, 3.5.12
Mean probability of dangerous failure PFH_D	1.34×10^{-8} l/h
Mean time to dangerous failure $MTTF_d$	$MTTF_d = 1 / PFH_D$
Safe failure fraction SFF	99.2%

The specified values apply for the combination with ionization electrode (sensor) and PFU 780 (logic).

Relationship between the Performance Level (PL) and the Safety Integrity Level (SIL)

PL	SIL
a	–
b	1
c	1
d	2
e	3

Pursuant to EN ISO 13849-1:2006, Table 4, the PFU can be used up to PL e.

Max. service life under operating conditions:

20 years after date of production, plus max. 1/2 year in storage prior to first use.

For a glossary of terms, see page 68 (Glossary).

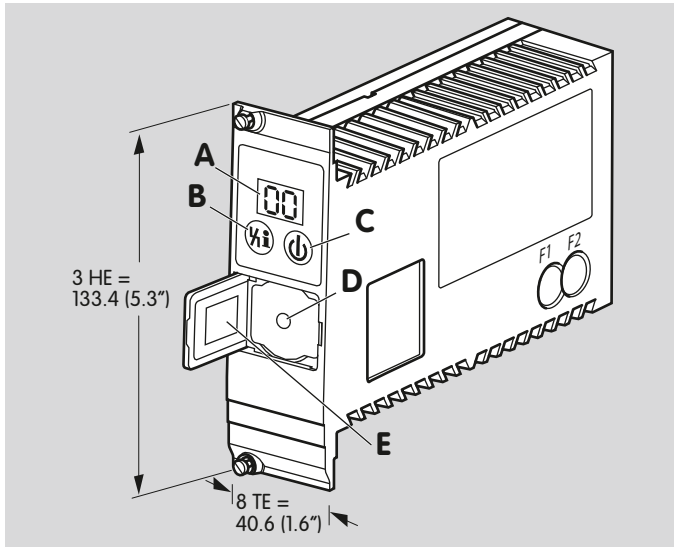

9.2 Operating controls

A: 2-digit 7-segment display

B: Reset/Information button to reset the system after a fault or to scan parameters on the display

C: Mains switch





















D: Optical interface

E: Type label

10 Maintenance cycles

Burner control unit PFU requires little servicing.

11 Legend

	Display
	Blinking display
	Ready
	Safety interlocks (Limits)
	Start-up signal, pilot burner
	Start-up signal, main burner
	Digital input
	Ignition transformer
	Gas valve
	Air valve
	Purge
	Ext. air valve control
	Flame signal
	Operating signal, pilot burner
	Operating signal, main burner
	Fault signal
	Reset
	Input signal
	Output signal
	Flame simulation check
t_W	Waiting time ≥ 2 s
t_{SA}	Safety time on start-up 3 s, 5 s or 10 s
t_{SB}	Safety time during operation < 1 s or < 2 s
t_Z	Ignition time 2 s, 3 s or 6 s
t_{LV}	Flame simulation delay time 25 s
t_{FS}	Flame proving period 0 – 25 s
t_B	Minimum combustion time t_{SA} up to max. 25 s
t_{BP}	Minimum burner pause time 0 – 250 s
t_{KN}	Low fire over run time 0 s, 5 s, 15 s or 25 s
	Input/Output safety circuit

12 Glossary

12.1 Waiting time t_W

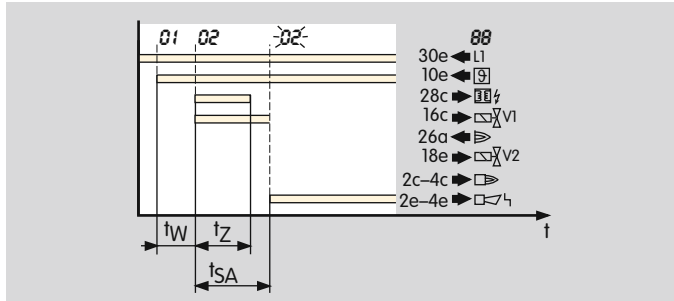

Once the start-up signal \ominus has been applied, the waiting time t_W starts to elapse. During this time, a self-test is conducted to detect errors in internal and external circuit components. If no malfunction is detected, the burner will start up.

12.2 Safety time on start-up t_{SA}

This refers to the period of time between switching on and switching off of the gas valve, when no flame signal is detected. The safety time on start-up t_{SA} (3, 5 or 10 s) is the minimum operating time of the burner and burner control unit.

12.3 Ignition time t_Z

If no malfunction is detected during the waiting time t_W , the ignition time t_Z then starts to elapse. Voltage is supplied to the pilot gas valve V1 and the ignition transformer and the burner is ignited. The duration of the ignition time is either 2, 3 or 7 seconds (depending on safety time t_{SA} selected).

12.4 Flame simulation/Flame simulation delay time t_{LV}

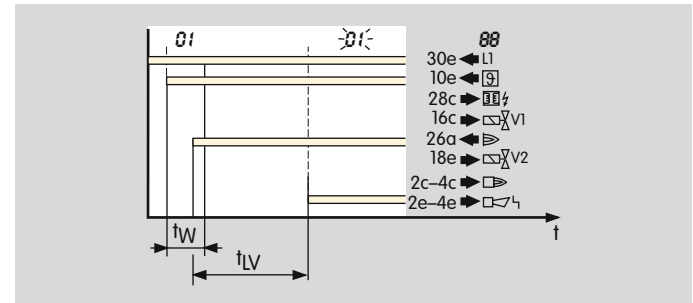

An extraneous signal (flame simulation) is a flame signal that is detected, although there should be no flame according to the program sequence. If such an extraneous signal is detected, the flame simulation delay time t_{LV} starts to elapse. If the flame simulation is discontinued during the flame simulation delay time t_{LV} , start-up can be initiated or operation continued. Otherwise, a fault lock-out occurs.

12.5 Safety time during operation t_{SB}

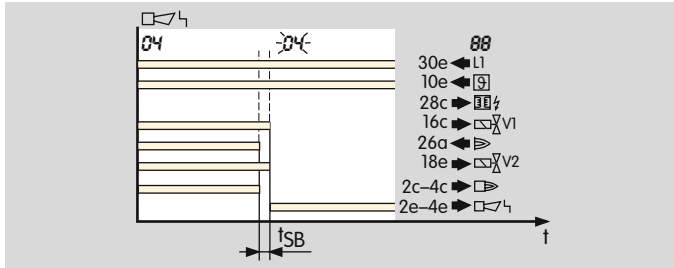

If the flame fails during operation, the valve outputs are disconnected within the safety time t_{SB} . The default safety time during operation t_{SB} in accordance with EN 298 is 1 second. In accordance with EN 746-2, the safety time of the installation during operation (including closing time of the valves) may not exceed 3 seconds (see “Project planning information”). Note the requirements of the Standards!

12.6 Flame signal

If a flame is detected, the flame detector will supply a flame signal.

12.7 Fault lock-out

In the event of a fault lock-out, all valves and the ignition transformer are disconnected from the electrical power supply, and a fault is signalled. Resetting must take place manually following a fault lock-out.

12.8 Safety interlocks (Limits)

The limiters in the safety interlock (linking of all the relevant safety control and switching equipment for the use of the application, e.g. safety temperature limiter, minimum/maximum gas pressure) must isolate input (△) from the voltage supply.

12.9 Pilot gas valve V1

The start fuel flow rate for the pilot burner is released by pilot gas valve V1. It opens when the safety time on start-up t_{SA1} starts to elapse. It remains open until the burner is switched off again by a normal shut-down or fault lock-out.

12.10 Main gas valve V2

The start fuel flow rate for the main burner is released by main gas valve V2. It opens when the safety time on start-up t_{SA2} starts to elapse. It remains open until the burner is switched off again by a normal shut-down or fault lock-out.

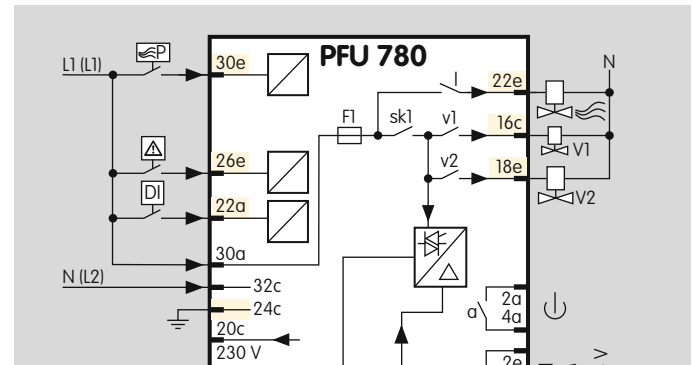

12.11 Continuous operation

The gas burner runs continuously for more than 24 hours.

12.12 Air valve

The air valve can be used

- for cooling,
- for purging,
- to control the burner capacity in ON/OFF mode and in High/Low mode when using a pneumatic air/gas ratio control system.

12.13 Diagnostic coverage DC

Measure of the effectiveness of diagnostics, which may be determined as the ratio between the failure rate of detected dangerous failures and the failure rate of total dangerous failures

NOTE: Diagnostic coverage can exist for the whole or parts of a safety-related system. For example, diagnostic coverage could exist for sensors and/or logic system and/or final elements. Unit: %.

from EN ISO 13849-1:2008

12.14 Mode of operation

High demand mode or continuous mode

Operating mode, where the frequency of demands for operation made on a safety-related system is greater than one per year or greater than twice the proof-test frequency

from EN 61508-4:2001

12.15 Safe failure fraction SFF

Fraction of safe failures related to all failures, which are assumed to appear

from EN 13611/A2:2011

12.16 Probability of dangerous failure PFH_D

Value describing the likelihood of dangerous failure per hour of a component for high demand mode or continuous mode. Unit: 1/h

from EN 13611/A2:2011

12.17 Mean time to dangerous failure MTTF_d

Expectation of the mean time to dangerous failure

from EN ISO 13849-1:2008

Feedback

Finally, we are offering you the opportunity to assess this “Technical Information (TI)” and to give us your opinion, so that we can improve our documents further and suit them to your needs.

Clarity

- Found information quickly
- Searched for a long time
- Didn't find information
- What is missing?
- No answer

Comprehension

- Coherent
- Too complicated
- No answer

Scope

- Too little
- Sufficient
- Too wide
- No answer



Use

- To get to know the product
- To choose a product
- Planning
- To look for information

Navigation

- I can find my way around
- I got “lost”
- No answer

My scope of functions

- Technical department
- Sales
- No answer

Remarks

Contact

Elster GmbH
Postfach 2809 · 49018 Osnabrück
Strothweg 1 · 49504 Lotte (Büren)
Germany

Tel +49 541 1214-0
Fax +49 541 1214-370
info@kromschroeder.com
www.kromschroeder.com

The current addresses of our international agents are available on the Internet:
www.kromschroeder.de/Weltweit.20.0.html?&L=1

We reserve the right to make technical modifications in the interests of progress.
Copyright © 2016 Elster GmbH
All rights reserved.

