

# 1/8 & 1/16 DIN Controllers and Indicators

## Product Manual



Manual Part Number: 51-52-25-122



This manual supplements the Concise Product manual supplied with each instrument at the time of shipment. Information in this installation, wiring and operation manual is subject to change without notice.

Copyright © June 2006, Honeywell Inc, all rights reserved. No part of this publication may be reproduced, transmitted, transcribed or stored in a retrieval system, or translated into any language in any form by any means without the written permission of Honeywell.

Copies of this manual are available in electronic format on the Honeywell web site (www.honeywell.com) Printed versions are available from Honeywell or its agents.

**Note:**

*It is strongly recommended that applications incorporate a high or low limit protective device, which will shut down the equipment at a preset process condition in order to prevent possible damage to property or products.*



**WARNING:**

**THE INTERNATIONAL HAZARD SYMBOL IS INSCRIBED ADJACENT TO THE REAR CONNECTION TERMINALS. IT IS IMPORTANT TO READ THIS MANUAL BEFORE INSTALLING OR COMMISSIONING THE UNIT.**

Products covered by this manual are suitable for Indoor use, Installation Category II, Pollution category 2 environments.

Products covered in this issue of the manual:

DC1200 & DC1700 Process Controllers  
DC120T & DC170T Valve Controllers  
DC120L Limit Controller  
DI1700 Indicator

## Warranty and Returns Statement

These products are sold by Honeywell under the warranties set forth in the following paragraphs. Such warranties are extended only with respect to a purchase of these products, as new merchandise, directly from Honeywell or from a Honeywell distributor, representative or reseller and are extended only to the first buyer thereof who purchases them other than for the purpose of resale.

### Warranty

These products are warranted to be free from functional defects in material and workmanship at the time the products leave Honeywell factory and to conform at that time to the specifications set forth in the relevant Honeywell instruction manuals sheet or sheets, for such products for a period of 18 Months.

**THERE ARE NO EXPRESSED OR IMPLIED WARRANTIES, WHICH EXTEND BEYOND THE WARRANTIES HEREIN AND ABOVE SET FORTH. HONEYWELL MAKES NO WARRANTY OF MERCHANTABILITY OR FITNESS FOR A PARTICULAR PURPOSE WITH RESPECT TO THE PRODUCTS.**

### Limitations

Honeywell shall not be liable for any incidental damages, consequential damages, special damages, or any other damages, costs or expenses excepting only the cost or expense of repair or replacement as described above. Products must be installed and maintained in accordance with Honeywell instructions. There is no warranty against damage to the product resulting from corrosion. Users are responsible for the suitability of the products to their application.

For a valid warranty claim, the product must be returned carriage paid to the supplier within the warranty period. The product must be properly packaged to avoid damage from Electrostatic Discharge or other forms of harm during transit.

# Contents

Page Number:

<b>Warranty and Returns Statement</b> .....	<b>iv</b>
<b>1 Introduction</b> .....	<b>10</b>
<b>2 Installation</b> .....	<b>11</b>
Unpacking .....	11
Installation.....	11
Panel Cut-outs .....	12
Panel-Mounting.....	12
<b>3 Plug-in Options</b> .....	<b>14</b>
Options Modules and Functions .....	14
Auto Detection of Option Modules .....	14
Preparing to Install or Remove Options Modules .....	16
Removing/Replacing Option Modules .....	16
Replacing the Instrument in its Housing .....	19
<b>4 Wiring Instructions</b> .....	<b>20</b>
Installation Considerations.....	20
AC Power Wiring - Neutral (for 100 to 240V AC versions).....	20
Wire Isolation .....	20
Use of Shielded Cable .....	21
Noise Suppression at Source .....	21
Sensor Placement (Thermocouple or RTD) .....	22
Thermocouple Wire Identification Chart .....	22
Connections and Wiring.....	23
Power Connections - Mains Powered Instruments .....	25
Power Connections - 24/48V AC/DC Powered Instruments .....	25
Universal Input Connections - Thermocouple (T/C).....	26
Universal Input Connections – PT100 (RTD) input.....	26
Universal Input Connections - Linear Volt, mV or mA input .....	27
Option Slot 1 – Relay Output Module.....	27
Option Slot 1 - SSR Driver Output Module.....	28
Option Slot 1 - Triac Output Module.....	28
Option Slot 1 - Linear Voltage or mADC Output module.....	28
Option Slot 2 - Relay Output Module.....	29
Option Slot 2 - SSR Driver Output Module.....	29
Option Slot 2 - Triac Output Module.....	29
Option Slot 2 - Dual Relay Output Module .....	30
Option Slot 2 - Linear Voltage or mADC Output module.....	30
Option Slot 3 - Relay Output Module.....	31
Option Slot 3 - SSR Driver Output Module.....	31

	Option Slot 3 - Linear Voltage or mADC Output module.....	31
	Option Slot 3 - Dual Relay Output Module .....	32
	Option Slot 3 - Transmitter Power Supply Module .....	32
	Option Slot A Connections - RS485 Serial Communications Module .....	33
	Option Slot A Connections - Digital Input Module .....	33
	Option Slot A Connections – Basic Auxiliary Input Module .....	33
	Option Slot B Connections – Digital Input 2 (Full Auxiliary Module) .....	34
	Option Slot B Connections – 1/8 DIN Full Auxiliary Input Module .....	34
<b>5</b>	<b>Powering Up .....</b>	<b>35</b>
	Powering Up Procedure .....	35
	Overview Of Front Panel.....	35
	Displays.....	36
	Keypad .....	36
	LED Functions.....	36
<b>6</b>	<b>Messages and Error Indications .....</b>	<b>37</b>
<b>7</b>	<b>Instrument Operation Modes .....</b>	<b>38</b>
	Select Mode .....	38
	Entry into the Select Mode .....	38
	Navigating in Select Mode .....	38
	Unlock Codes.....	39
	Automatic Tune Mode.....	39
	Navigating in Automatic Tune Mode.....	39
	Product Information Mode.....	40
	Navigating in the Product Information Mode .....	40
	Lock Code View .....	42
	Entry and Navigating in Lock Code View Mode .....	42
<b>8</b>	<b>DC1200 &amp; DC1700 Controller – Model Group.....</b>	<b>43</b>
	DC1200 & DC1700 Controllers - Configuration Mode .....	43
	Entry into the Configuration Mode .....	43
	Scrolling through Parameters and Values .....	43
	Changing Parameter Values .....	44
	DC1200 & DC1700 – Setup Mode.....	50
	Entry into the Setup Mode .....	50
	Scrolling through Parameters & Values.....	50
	Changing Parameter Values .....	50
	DC1200 & DC1700 Controllers - Operator Mode .....	54
	DC1200 & DC1700 Controllers – Extended Operator Mode.....	54
	Navigating in Operator Mode.....	54
	Adjusting the Local Setpoint(s) .....	56
	Adjusting the Setpoint Ramp Rate.....	56

Manual Control Mode.....	57
Selecting/deselecting Manual Control Mode .....	57
DC1200 & DC1700 Controllers –Communications Parameters .....	58
Bit Parameters .....	58
Word Parameters .....	58
<b>9 DC120T &amp; DC170T VMD Controller – Model Group.....</b>	<b>63</b>
Special Wiring Considerations for Valve Motor Control.....	63
DC120T & DC170T VMD Controllers - Configuration Mode .....	64
Entry into the Configuration Mode.....	64
Scrolling through Parameters and Values.....	64
Changing Parameter Values .....	64
DC120T & DC170T – Setup Mode .....	72
Entry into the Setup Mode .....	72
Scrolling through Parameters & Values .....	72
Changing Parameter Values .....	72
Adjusting the Valve Parameters.....	72
Set Valve Opened Position & Set Valve Closed Position .....	73
Valve Position Clamping.....	73
DC120T & DC170T Controllers - Operator Mode.....	76
DC120T & DC170T Controllers – Extended Operator Mode .....	76
Navigating in Operator Mode.....	76
Adjusting the Local Setpoint(s) .....	78
Adjusting the Setpoint Ramp Rate.....	78
Manual Control Mode.....	79
Selecting/deselecting Manual Control Mode .....	79
DC120T & DC170T Controllers – Serial Communications Parameters .....	80
Bit Parameters .....	80
Word Parameters .....	80
<b>10 Model DC120L Limit Controller .....</b>	<b>83</b>
DC120L Limit Controller - Configuration Mode.....	83
Entry into the Configuration Mode.....	83
Scrolling through Parameters and Values.....	83
Changing Parameter Values .....	84
DC120L Limit Controller – Setup Mode .....	89
Entry into the Setup Mode .....	89
Scrolling through Parameters & Values .....	89
Changing Parameter Values .....	89
DC120L Limit Controller - Operator Mode .....	91
Navigating in Operator Mode.....	91
Limit Setpoint Adjustment .....	92

Exceed Condition .....	92
Limit Output Function .....	92
Limit Annunciator Outputs.....	92
Resetting Limit Outputs & Annunciators .....	92
Using The Reset Key To Reset Limit Outputs & Annunciators .....	92
Resetting Limit Hold and Exceed Time.....	93
To reset the stored Limit Hold and Exceed Time values.....	93
DC120L Controller – Serial Communications Parameters .....	94
Bit Parameters .....	94
Word Parameters.....	94
<b>11 DI1700 Indicator .....</b>	<b>98</b>
DI1700 Indicator - Configuration Mode .....	98
Entry into the Configuration Mode .....	98
Scrolling through Parameters and Values .....	99
Changing Parameter Values .....	99
DI1700 Indicator - Setup Mode .....	106
Entry into the Setup Mode .....	106
Scrolling through Parameters and Values .....	106
Changing Parameter Values .....	106
DI1700 Indicator - Operator Mode .....	110
Entry into Operator Mode .....	110
Scrolling through Parameters and Values .....	110
Changing Parameter Values .....	110
Indicator Units Display .....	112
Alarm Indications.....	112
Resetting Latched Alarm Outputs .....	112
Resetting Alarm 1 Active Time, Minimum PV or Maximum PV .....	112
Multi-Point Scaling .....	113
Tare Feature .....	113
DI1700 Indicator – Serial Communications Parameters.....	114
Bit Parameters .....	114
Word Parameters.....	115
<b>12 Manually Tuning Controllers.....</b>	<b>118</b>
Single Control Tuning (PID with Primary Output only).....	118
Dual Control Tuning (PID with Primary and Secondary Outputs).....	119
Valve Control Tuning (PI with VMD or Linear Outputs) .....	119
Manually Fine Tuning.....	121
<b>13 Modbus Serial Communications .....</b>	<b>122</b>
Physical Layer .....	122
Link Layer.....	123



Device Addressing .....	124
Supported Modbus Functions .....	124
Function Descriptions .....	124
Read Coil/Input Status (Function 01 / 02) .....	125
Read Holding/Input Registers (Function 03 / 04) .....	125
Force Single Coil (Function 05) .....	126
Pre-Set Single Register (Function 06) .....	126
Loopback Diagnostic Test (Function 08) .....	126
Pre-Set Multiple Registers (Function 10 Hex) .....	127
Exception Responses .....	127
<b>14 ASCII Communications .....</b>	<b>128</b>
Physical Layer .....	128
Device Addressing .....	128
Session Layer .....	128
Type 1 Message .....	129
Type 2 Message .....	130
Type 3 Message .....	130
Type 4 Message .....	131
Error Response .....	131
<b>15 Calibration Mode .....</b>	<b>132</b>
Equipment Required For Checking or Calibrating the Universal Input .....	132
Calibration Check .....	132
Recalibration Procedure .....	133
<b>16 Appendix 1 – Glossary .....</b>	<b>134</b>
Active Setpoint   Type: <i>Controller Definition</i> .....	134
Actual Setpoint   Type: <i>Controller Definition</i> .....	134
Alarm Hysteresis   Type: <i>General Parameter</i> .....	135
Alarm Operation   Type: <i>General Definition</i> .....	136
Alarm Inhibit   Type: <i>General Parameter</i> .....	137
Annunciator   Type: <i>Limit Controller Definition</i> .....	137
Automatic Reset (Integral)   Type: <i>Controller Tuning Parameter</i> .....	137
Auto Pre-Tune   Type: <i>Controller Tuning Parameter</i> .....	137
Auxiliary Input   Type: <i>General Definition</i> .....	137
Band Alarm 1 Value   Type: <i>General Parameter</i> .....	137
Band Alarm 2 Value   Type: <i>General Parameter</i> .....	137
Bias (Manual Reset)   Type: <i>Controller Tuning Parameter</i> .....	138
Bumpless Transfer   Type: <i>Controller Definition</i> .....	138
Boundless VMD Control   Type: <i>VMD Controller Definition</i> .....	138
Cascade Control   Type: <i>Controller Definition</i> .....	138
Communications Write Enable   Type: <i>General Definition</i> .....	139

Control Type	Type: <i>Controller Parameter</i>	139
Controller	Type: <i>Controller Definition</i>	139
CPU	Type: <i>General Definition</i>	139
Current Proportioning Control	Type: <i>Controller Definition</i>	139
Cycle Time	Type: <i>Controller Definition</i>	139
Deadband	Type: <i>Controller Parameter</i>	140
Derivative	Type: <i>Controller Parameter</i>	140
Deviation Alarm 1 Value	Type: <i>General Parameter</i>	140
Deviation Alarm 2 Value	Type: <i>General Parameter</i>	140
Differential (On-Off Hysteresis)	Type: <i>Controller Parameter</i>	140
Direct/Reverse Action of Control Outputs	Type: <i>Controller Definition</i>	140
Display Strategy	Type: <i>General Parameter</i>	140
Elapsed Time	Type: <i>Indicator Definition</i>	141
Exceed Condition	Type: <i>Limit Controller Definition</i>	141
Exceed Time	Type: <i>Limit Controller Definition</i>	141
Indicator	Type: <i>Indicator Definition</i>	141
Input Filter Time Constant	Type: <i>General Parameter</i>	141
Input Range	Type: <i>General Definition</i>	141
Input Span	Type: <i>General Definition</i>	141
Integral	Type: <i>Controller Tuning Parameter</i>	141
Latching Relay	Type: <i>General Definition</i>	142
LED	Type: <i>General Definition</i>	142
Limit Controller	Type: <i>Limit Controller Definition</i>	142
Limit Hysteresis	Type: <i>Limit Controller Definition</i>	142
Limit Setpoint	Type: <i>Limit Controller Definition</i>	142
Lock Codes	Type: <i>General Parameter</i>	142
Logical Combination of Alarms	Type: <i>General Definition</i>	143
Loop Alarm Enable	Type: <i>Controller Parameter</i>	143
Loop Alarm Time	Type: <i>Controller Parameter</i>	144
mADC	Type: <i>General Definition</i>	144
Manual Mode	Type: <i>Controller Definition</i>	144
Manual Mode Enable	Type: <i>Controller Parameter</i>	145
Master & Slave	Type: <i>Controller Definition</i>	145
Minimum Motor On Time	Type: <i>VMD Controller Parameter</i>	145
Modulating Valve	Type: <i>VMD Controller Definition</i>	145
Motor Travel Time	Type: <i>VMD Controller Parameter</i>	146
Multi-Point Scaling Enable	Type: <i>Indicator Parameter</i>	146
Multi-Point Scaling Set Up	Type: <i>Indicator Parameter</i>	146
Offset	Type: <i>Controller Parameter</i>	147
On-Off Control	Type: <i>Controller Definition</i>	147
On-Off Differential (Hysteresis)	Type: <i>Controller Parameter</i>	147

Open Loop VMD	Type: <i>VMD Controller Definition</i>	147
Overlap/Deadband	Type: <i>Controller Parameter</i>	147
PI Control	Type: <i>Controller Definition</i>	148
PID Control	Type: <i>Controller Definition</i>	148
PLC	Type: <i>General Definition</i>	149
Pre-Tune	Type: <i>Controller Definition</i>	149
Primary Output Power Limit	Type: <i>Controller Parameter</i>	150
Primary Proportional Band	Type: <i>Controller Tuning Parameter</i>	150
Process High Alarm 1 Value	Type: <i>General Parameter</i>	150
Process High Alarm 2 Value	Type: <i>General Parameter</i>	150
Process Low Alarm 1 Value	Type: <i>General Parameter</i>	150
Process Low Alarm 2 Value	Type: <i>General Parameter</i>	150
Process Variable (PV)	Type: <i>General Definition</i>	151
Process Variable Offset	Type: <i>General Parameter</i>	151
Rate (Derivative)	Type: <i>Controller Tuning Parameter</i>	151
Remote Setpoint (RSP)	Type: <i>Controller Definition</i>	151
Remote Auxiliary Input Range	Type: <i>Controller Parameter</i>	151
Remote Setpoint Lower Limit	Type: <i>Controller Parameter</i>	151
Remote Setpoint Upper Limit	Type: <i>Controller Parameter</i>	152
Remote Setpoint Offset	Type: <i>Controller Parameter</i>	152
Retransmit Output	Type: <i>General Definition</i>	152
Retransmit Output 1 Scale Maximum	Type: <i>General Parameter</i>	152
Retransmit Output 1 Scale Minimum	Type: <i>General Parameter</i>	152
Retransmit Output 2 Scale Maximum	Type: <i>General Parameter</i>	153
Retransmit Output 2 Scale Minimum	Type: <i>General Parameter</i>	153
Retransmit Output 3 Scale Maximum	Type: <i>General Parameter</i>	153
Retransmit Output 3 Scale Minimum	Type: <i>General Parameter</i>	153
Reset	Type: <i>Controller Tuning Parameter</i>	153
Reverse Acting	Type: <i>Controller Definition</i>	153
Scale Range Upper Limit	Type: <i>General Parameter</i>	153
Scale Range Lower Limit	Type: <i>General Parameter</i>	154
Secondary Proportional Band	Type: <i>Controller Tuning Parameter</i>	154
Self-Tune	Type: <i>Controller Tuning Definition</i>	154
Serial Communications Option	Type: <i>General Definition</i>	155
Set Valve Closed Position	Type: <i>VMD Controller Parameter</i>	155
Set Valve Opened Position	Type: <i>VMD Controller Parameter</i>	155
Setpoint	Type: <i>Controller Definition</i>	155
Setpoint Upper Limit	Type: <i>Controller Parameter</i>	156
Setpoint Lower Limit	Type: <i>Controller Parameter</i>	156
Setpoint Ramping Enable	Type: <i>Controller Parameter</i>	156
Setpoint Ramp Rate	Type: <i>Controller Parameter</i>	156

	Setpoint Select    Type: <i>Controller Parameter</i> .....	157
	Setpoint Select Enable    Type: <i>Controller Parameter</i> .....	157
	Solid State Relay (SSR)    Type: <i>General Definition</i> .....	157
	Solenoid Valve    Type: <i>General Definition</i> .....	157
	Tare    Type: <i>Indicator Parameter</i> .....	158
	Three Point Stepping Control    Type: <i>VMD Controller Definition</i> .....	158
	Time Proportioning Control    Type: <i>Controller Definition</i> .....	158
	Tuning    Type: <i>Controller Definition</i> .....	158
	Triac    Type: <i>General Definition</i> .....	158
	Valve Close Limit    Type: <i>VMD Controller Parameter</i> .....	159
	Valve Motor Drive Control    Type: <i>VMD Controller Definition</i> .....	159
	Valve Position or Flow Indication    Type: <i>VMD Controller Definition</i> .....	159
	Valve Open Limit    Type: <i>VMD Controller Parameter</i> .....	159
	VMD    Type: <i>VMD Controller Parameter</i> .....	160
<b>17</b>	<b>Appendix 2 - Specification .....</b>	<b>161</b>
	Universal Input .....	161
	General Input Specifications.....	161
	Thermocouple.....	161
	Thermocouple Ranges Available.....	161
	Thermocouple Performance .....	162
	Resistance Temperature Detector (RTD).....	162
	RTD Ranges Available.....	162
	RTD Performance .....	163
	DC Linear.....	163
	DC Linear Ranges Available.....	163
	DC Linear Performance .....	163
	Auxiliary Inputs.....	164
	Digital Inputs .....	164
	Output Specifications .....	165
	Output Module Types .....	165
	Specifications of Output Types.....	165
	Control Specifications .....	167
	Process Alarms .....	167
	Digital Communications .....	167
	Reference Conditions.....	168
	Operating Conditions .....	168
	Standards.....	168
	Physical Specifications.....	168
<b>18</b>	<b>Appendix 3 - Product Coding.....</b>	<b>169</b>

## How to use this manual

This manual is structured to give easy access to the information required for all aspects of the installation and use and of the products:

- Section 1: **Introduction** - A brief description of the product range.
- Section 2: **Installation** - Unpacking, installing and panel mounting instructions.
- Section 3: **Plug-in Options** - Installation of the plug-in option modules.
- Section 4: **Wiring Guidelines** - Guidance on good wiring practice, noise avoidance, wiring diagrams and input/output connections.
- Section 5: **Powering Up** - Powering up procedure and descriptions of displays & switches.
- Section 6: **Messages & Error Indications** - Display Messages and fault indications.
- Section 7: **Operation Modes** - Describes operating modes common across the range. These include Select Mode for gaining access to the Setup and Configuration menus, Automatic tuning on controllers and the Product information menus.
- Section 8: **DC1200 & DC1700 Model Group** - Describes unique operating features of these process controllers. It covers the Configuration, Setup & Operator menus, Communications parameters, adjusting Setpoint, use of Manual Control and PID auto-tuning.
- Section 9: **DC120T & DC170T Model Group** - Describes unique operating features of these valve motor controllers. It covers the Configuration, Setup & Operator menus, Communications parameters, adjusting Setpoint, use of Manual Control and PID auto-tuning.
- Section 10: **Model DC120L** - Describes unique operating features of these limit controllers. It covers the Configuration, Setup & Operator menus, Communications parameters, adjusting the Limit Setpoint and resetting the Limit Output.
- Section 11: **Model DI1700** - Describes unique operating features of these indicators. It covers the Configuration, Setup & Operator menus, Communications parameters, using the Tare and Multi-Point Scaling Functions.
- Section 12: **Manually Tuning Controllers** - Advice on manually adjusting the Process and Valve Controllers tuning parameters.
- Section 13: **Modbus Serial Communications** - Details the physical layer and message formats used for the Modbus communications protocol common to all products in the range.
- Section 14: **ASCII Serial Communications** - Details the physical layer and message formats used for the ASCII serial communications protocol available on some products.
- Section 15: **Calibration Mode** - Step-by-step instructions to calibrate the instrument. This section is intended for use by suitably qualified personnel.
- Appendix 1: **Glossary** - Explanations of the terms used and product features.
- Appendix 2: **Specification** - Technical specifications for all products in the range.
- Appendix 3: **Product Coding** - Product model/ordering codes.

## 1 Introduction

These instruments are microprocessor based indicators, process and valve controllers, and indicators. They can measure, display or control process variables such as temperature, pressure, flow and level from a variety of inputs. Models are available in two sizes.  $\frac{1}{16}$  DIN (48 x 48mm front) and  $\frac{1}{8}$  DIN (48 x 96mm front).

The operating voltage is either 100-240V at 50/60 Hz or 24V-48V AC/DC depending on the model purchased. EEPROM technology protects against data or configuration loss during power outages.

Inputs are user configurable for connection to thermocouple and RTD probes, as well as linear process signal types such as mVDC, VDC or mADC. Output options include relays, SSR drivers, triacs or linear mV/voltage modules. These can be used for process control, valve control, alarms or retransmission of the process variable or setpoint to external devices such as data recorders or PLC's. A Transmitter Power Supply option module can provide an unregulated 24V DC (22mA) auxiliary output voltage for external signal transmitters.

Alarm indication is standard on all instruments; up to five alarms are possible on the indicators. Alarms may be set as process high or low, deviation (active above or below controller setpoint), band (active both above and below setpoint), or control loop types. Models with a heater current input also have high, low or short circuit heater break alarms based on control load current. These alarms can be linked to any suitable output. Alarm status is indicated by LED's or the alarm status screen.

Controllers can be programmed for on-off, time proportioning, or current proportioning control implementations, depending on the output modules fitted, and feature manual or automatic tuning of the PID parameters. A secondary control output is available when additional output modules are fitted. Valve Motor Drive (Three Point Stepping Control) is possible on some models. Optional analogue controller Remote Setpoint inputs included in the range. Control functions, alarm settings and other parameters are easily adjusted from the front keypad or via PC based configuration software.

Limit Controllers shut down a process in order to prevent possible damage to equipment or products. They have latching relay, which cannot be reset until the process is in a safe condition. Limit controllers work independently of the normal process controller and have approvals for safety critical applications.

Indicator models can display a process value and provide multiple stage alarm outputs. Additional features include Multipoint scaling to compensate for non-linear signals and a Tare function to auto-zero the current reading.



## 2 Installation

### Unpacking

1. Remove the product from its packing. Retain the packing for future use, in case it is necessary to transport the instrument to a different site or to return it to the supplier for repair/testing.
2. The instrument is supplied with a panel gasket and push fit fixing strap. A single sheet concise manual is also supplied in one or more languages. Examine the delivered items for damage or defects. If any are found, contact your supplier immediately.

### Installation

**CAUTION:**

Installation and configuration should be performed only by personnel who are technically competent and authorised to do so. Local regulations regarding electrical installation and safety must be observed.

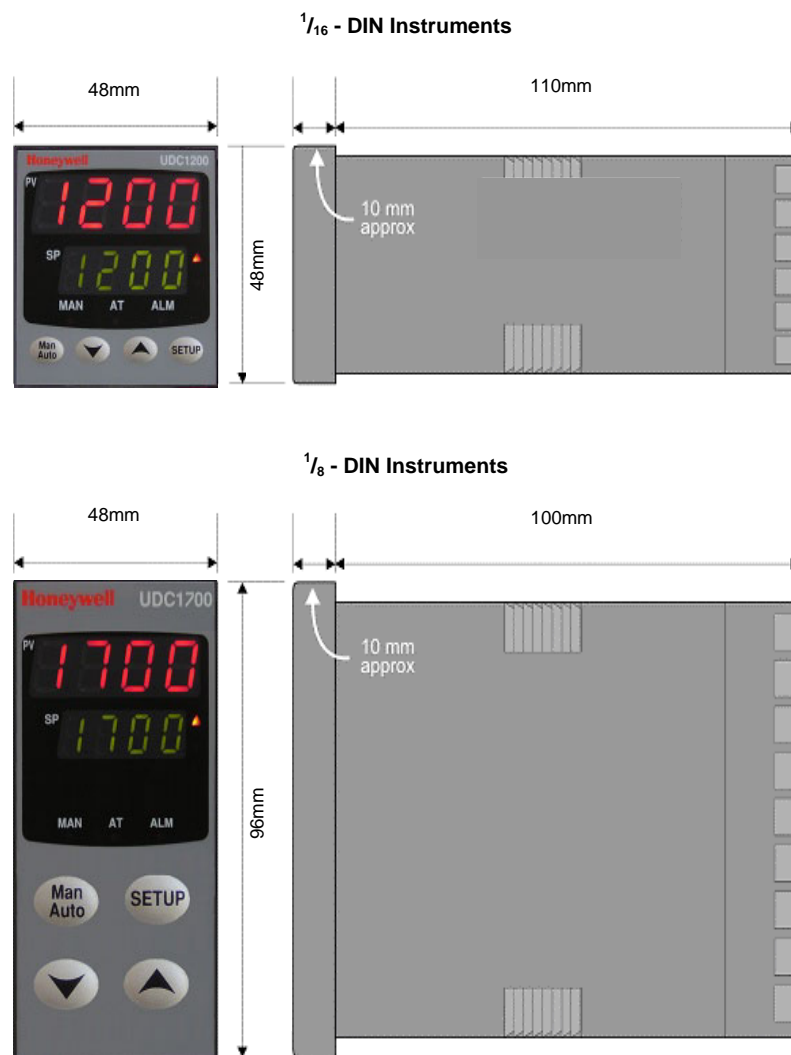

Figure 1. Main dimensions

### Panel Cut-outs

The mounting panel must be rigid and may be up to 6.0mm (0.25 inches) thick. The cut-outs required for the instruments are shown below.

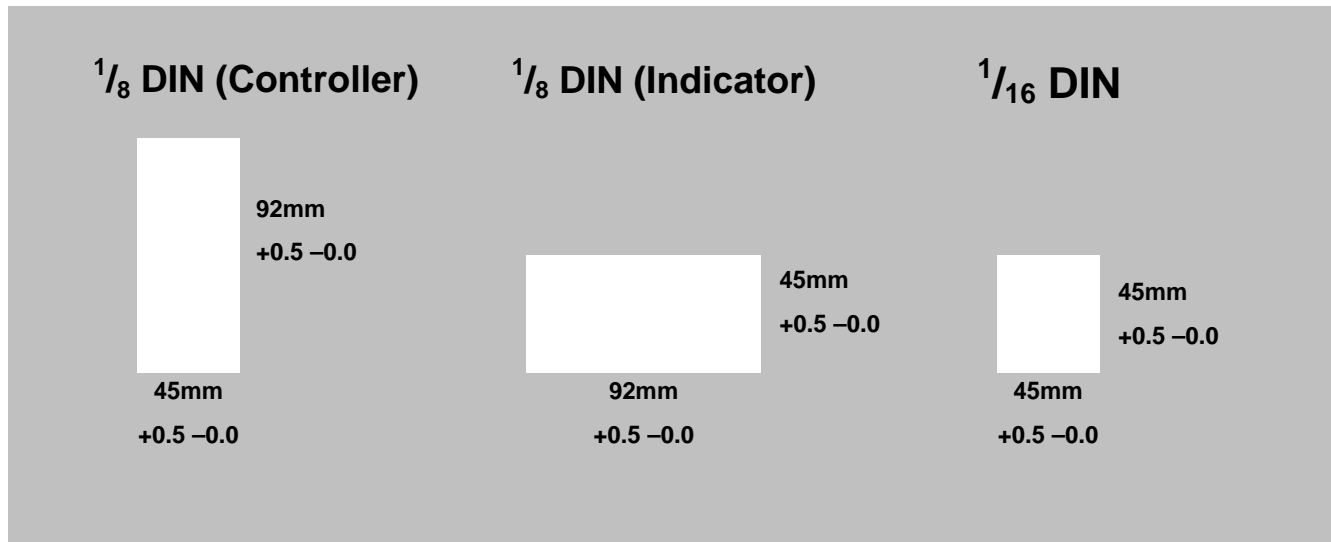

Figure 2. Panel cut-out sizes

### Panel-Mounting

#### CAUTION:

Ensure the inside of the panel is with the instruments operating temperature and that there is adequate air flow to prevent overheating.

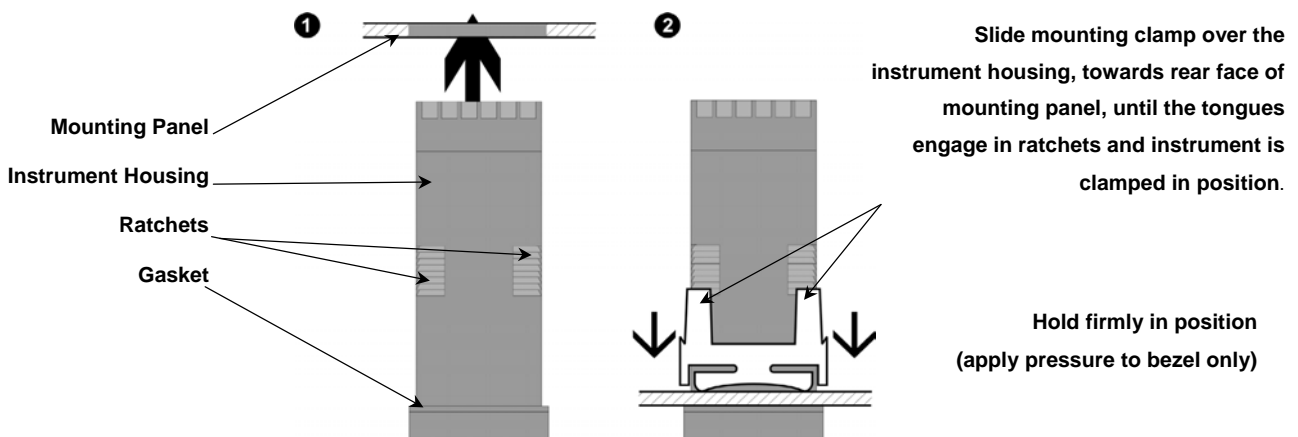

Figure 3. Panel-Mounting the instrument

#### CAUTION:

Do not remove the panel gasket, as this may result in inadequate clamping and sealing of the instrument to the panel.



Once the instrument is installed in its mounting panel, it may be subsequently removed from its housing, if necessary, as described in the Fitting and Removing Option Modules section.

Instruments may be mounted side-by-side in a multiple installation, but instrument to panel moisture and dust sealing will be compromised. The cut-out width (for n instruments) is shown below.

$\frac{1}{8}$  - &  $\frac{1}{16}$  - DIN Instruments (excluding DI1700 Indicators):

(48n - 4) mm or (1.89n - 0.16) inches.

DI1700 Indicators:

(96n - 4) mm or (3.78n - 0.16) inches

If panel sealing must be maintained, mount each instrument into an individual cut-out with 6mm or more clearance between the edges of the holes.

**Note:**

*The mounting clamp tongues may engage the ratchets either on the sides or the top/bottom faces of the Instrument housing. When installing several Instruments side-by-side in one cut-out, use the ratchets on the top/bottom faces.*

### 3 Plug-in Options

#### Options Modules and Functions

A range of plug-in option modules is available to add additional input, output and communication functions to the instruments in the range. These modules can be either pre-installed at the time of manufacture, or retrofitted in the field.

The modules are installed between the instruments main circuit boards into the four option slots. These are designated as Slots 1, 2, 3, A & B. Installation is detailed below.

**Note:**

*Slot 1 modules cannot be fitted into Slot 2 or 3. Slot 2 & 3 modules cannot be fitted into Slot 1. Some Slot 2 & 3 modules should only be fitted into one of the two slots. This is detailed in the - Option Module vs. Model Matrix below.*

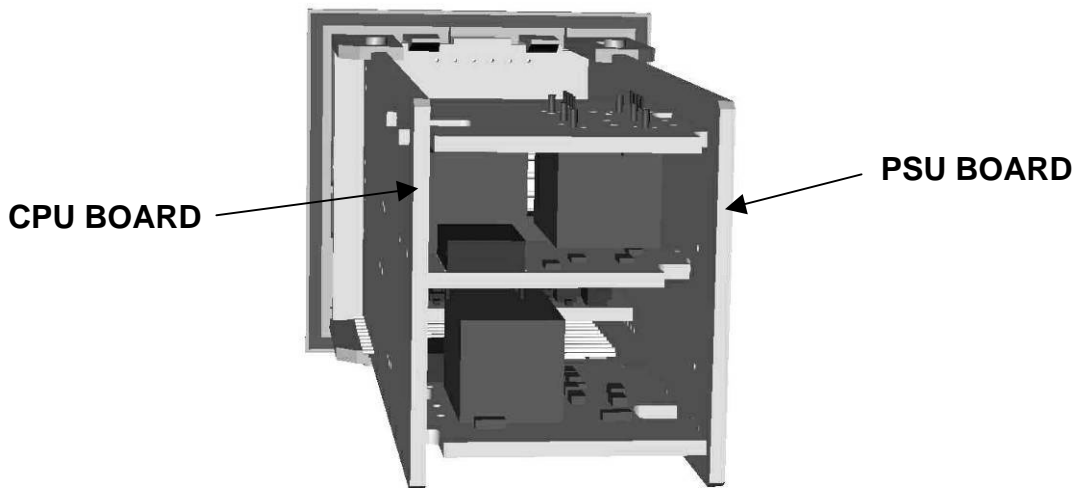

Figure 4. Typical rear view (uncased) & main board positions

#### Auto Detection of Option Modules

The instrument automatically detects which option modules have been fitted into each slot. In Configuration Mode, the menus will change to reflect the options compatible with the hardware fitted. The modules fitted can be viewed in the products information menu, as detailed in the Product Information Mode section of this manual.

Table 1. Option Module vs. Model Matrix

MODULE PART NUMBER & Function	MODEL NUMBER					
	UDC1200	UDC120L	UDC120T	UDC1700	UDC170T	UDI1700
<b>OPTION SLOT 1</b>						
51453391-501 Relay						
51453391-502 SSR Driver						
51453391-503 Triac						
51453391-504 Linear mA/V DC						
<b>OPTION SLOT 2</b>						
51453391-506 Relay						
51453391-507 SSR Driver						
51453391-508 Triac						
51453391-509 Linear mA/V DC						
51453391-510 Dual Relay						
<b>OPTION SLOT 3</b>						
51453391-506 Relay						
51453391-507 SSR Driver						
51453391-509 Linear mA/V DC						
51453391-510 Dual Relay						
51453391-111 Transmitter PSU						
<b>OPTION SLOT A</b>						
51453391-512 RS485 Comms						
51453391-513 Digital Input						
51453391-515 Basic Aux Input						
<b>OPTION SLOT B</b>						
51453391-516 Full Aux Input						
<b>SOFTWARE &amp; ACCESSORIES</b>						
51453391-514 Config Software						
<b>KEY</b>	Option Possible			Option Not Possible		

### Preparing to Install or Remove Options Modules

**CAUTION:**

Before removing the instrument from its housing, ensure that all power has been removed from the rear terminals.

1. Remove the instrument from its housing by gripping the side edges of the front panel (there is a finger grip on each edge) and pull the instrument forwards. This will release the instrument from the rear connectors in the housing and will give access to the PCBs.
2. Take note of the orientation of the instrument for subsequent replacement into the housing. The positions of the main and option PCBs in the instrument are shown below.

### Removing/Replacing Option Modules

With the instrument removed from its housing:

1. To remove or replace modules into Option Slots 1,A or B, it is necessary to gently separate the CPU and PSU PCBs. This is achieved by detaching the main boards (PSU and CPU) from the front moulding by lifting first the upper and then lower mounting struts as shown. This frees the boards from the front. If only Option slots 2 or 3 are to be changed, this stage is not required as these slots are accessible without separating the main boards from the front.

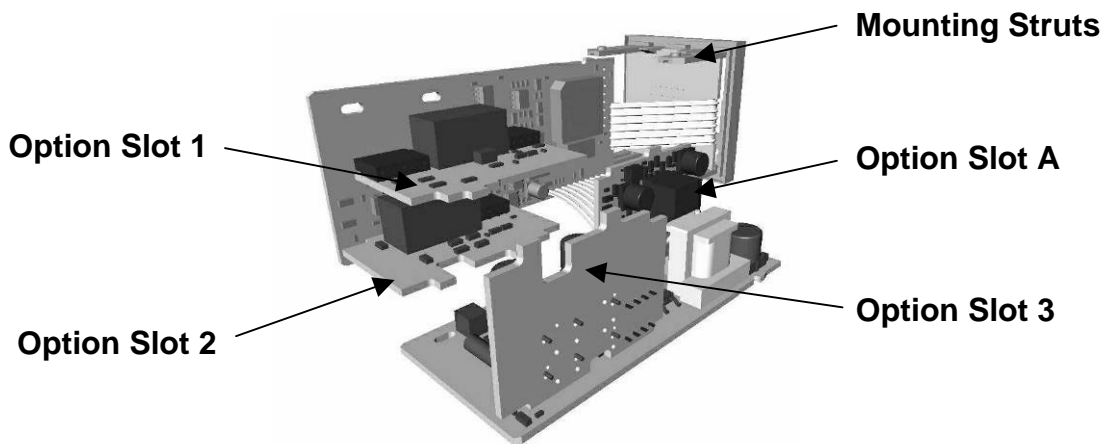

Figure 5. Location of Option Modules - 1/16 DIN Instruments

**CAUTION:**

Take care not to put undue stress on the ribbon cable attaching the display and CPU boards.

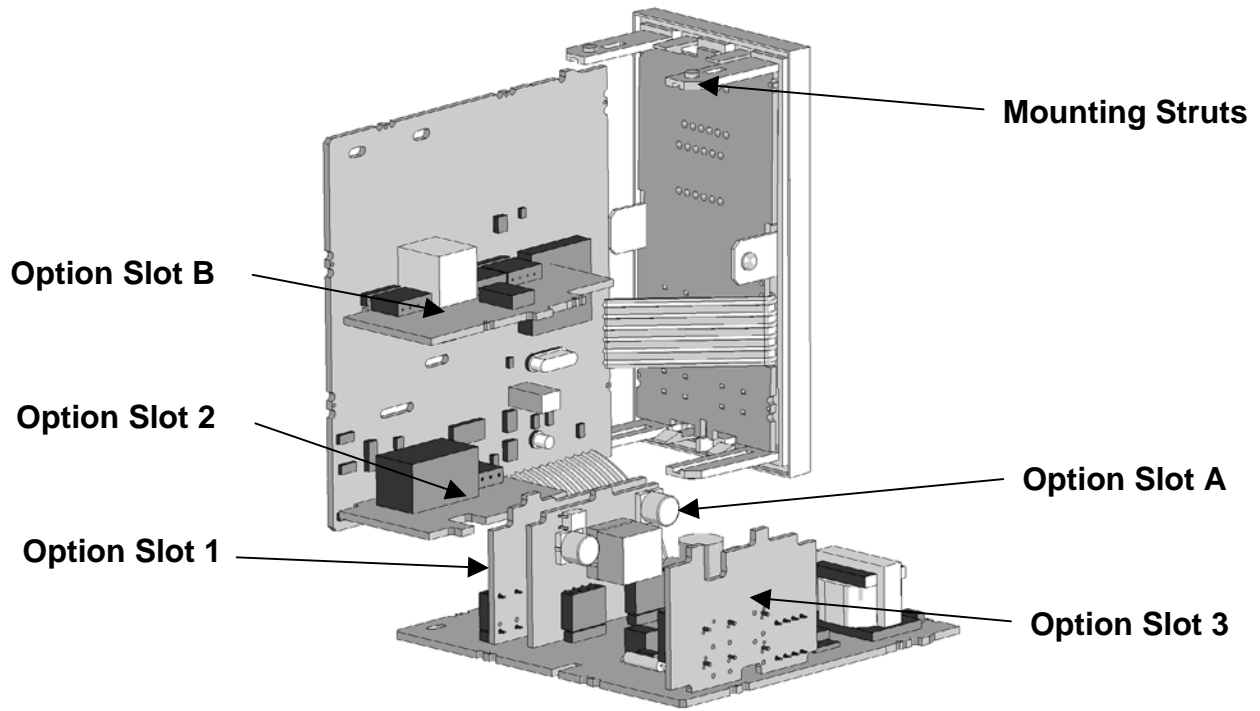

Figure 6. Location of Option Modules - 1/8 DIN Instruments

**CAUTION:**

Take care not to put undue stress on the ribbon cable attaching the display and CPU boards.

- Remove or fit the modules into the Option slots as required. The location of the connectors is shown below. Tongues on each option module locate into a slots cut into the main boards, opposite each of the connectors.

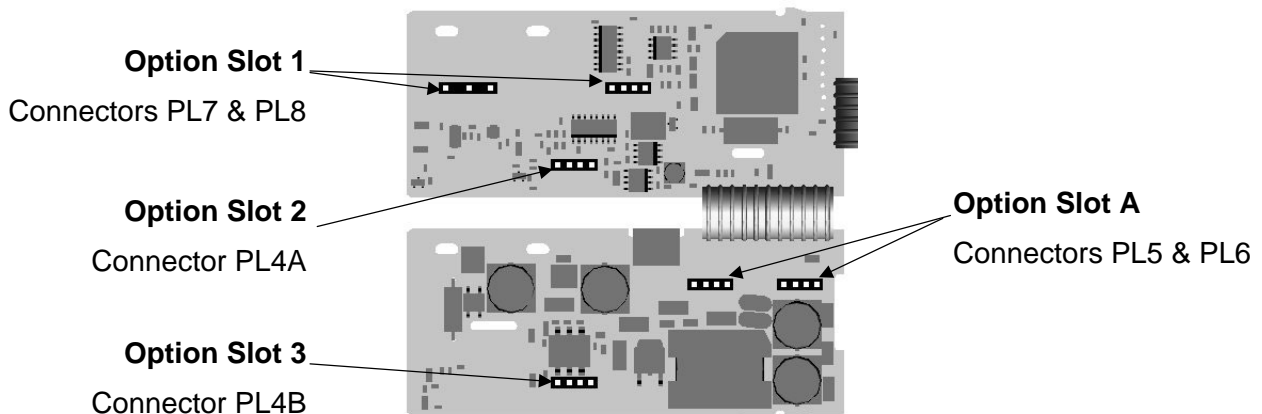

Figure 7. Option Module Connectors - 1/16 DIN Instruments

**CAUTION:**

Check for correct orientation of the modules and that all pins locate correctly into the socket

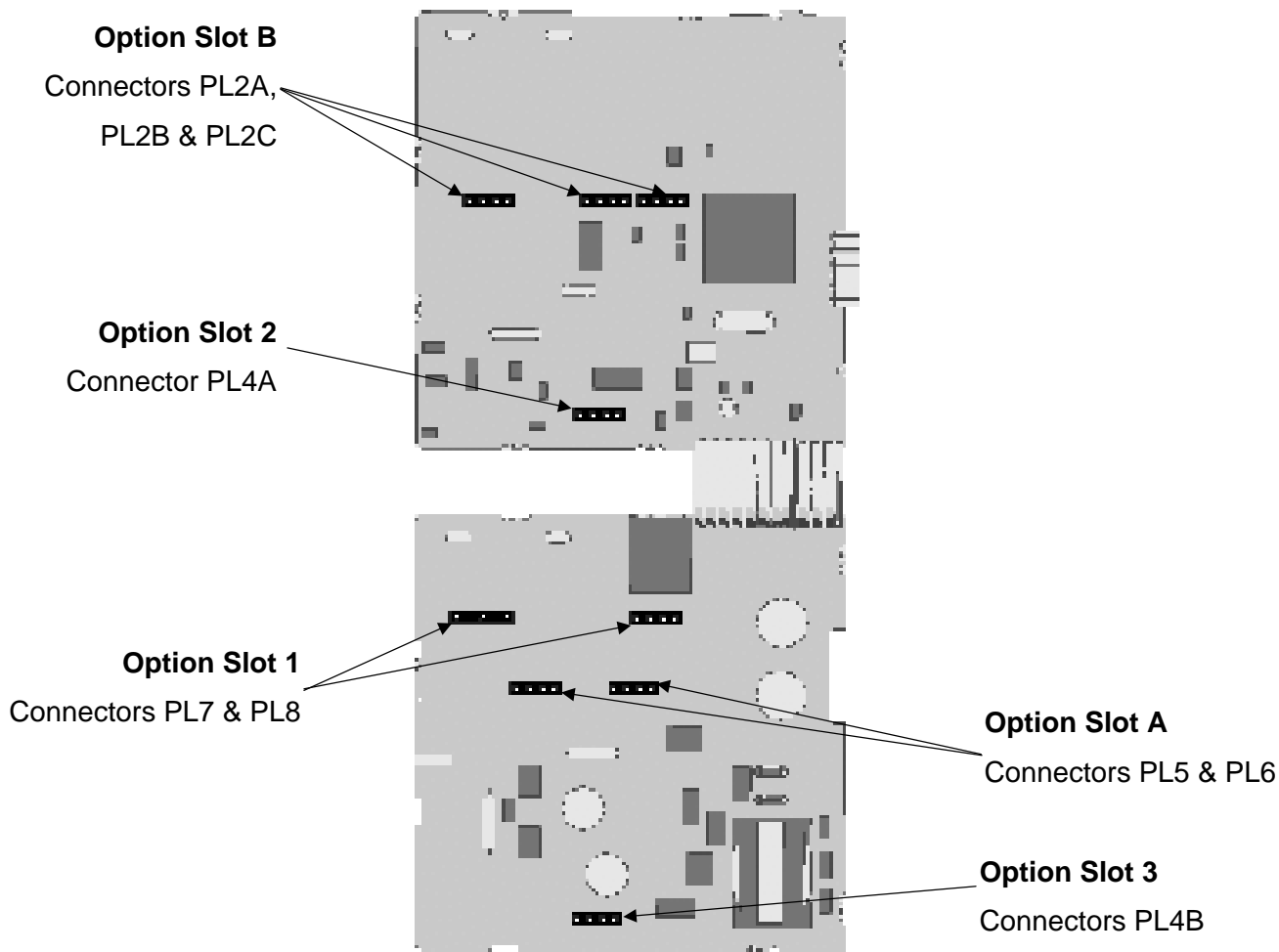

Figure 8. Option Module Connectors - 1/8 DIN Instruments

**CAUTION:**

Check for correct orientation of the modules and that all pins locate correctly into the socket

## Replacing the Instrument in its Housing

With the required option modules correctly located into their respective positions the instrument can be replaced into its housing as follows:

1. If required, move the CPU and PSU boards back together, taking care to locate the option module tongues into the slots in the board opposite. Hold the main boards together whilst relocating them back into the mounting struts on the front panel.
2. Align the CPU and PSU PCBs with their guides and connectors in the housing.
3. Slowly and firmly, push the instrument in position.

### **CAUTION:**

**Ensure that the instrument is correctly orientated. A mechanical stop will operate if an attempt is made to insert the instrument in the wrong orientation, this stop MUST NOT be over-ridden.**

### 4 Wiring Instructions

Electrical noise is a phenomenon typical of industrial environments. As with any instrumentation, these guidelines should be followed to minimize the effect of noise.

#### Installation Considerations

Ignition transformers, arc welders, mechanical contact relays and solenoids are all common sources of electrical noise in an industrial environment and therefore the following guidelines MUST be followed.

1. If the instrument is being installed in existing equipment, the wiring in the area should be checked to ensure that good wiring practices have been followed.
2. Noise-generating devices such as those listed should be mounted in a separate enclosure. If this is not possible, separate them from the instrument, by the largest distance possible.
3. If possible, eliminate mechanical contact relays and replace with solid-state relays. If a mechanical relay being powered by an output of this instrument cannot be replaced, a solid-state relay can be used to isolate the instrument.
4. A separate isolation transformer to feed only the instrumentation should be considered. The transformer can isolate the instrument from noise found on the AC power input.

#### AC Power Wiring - Neutral (for 100 to 240V AC versions)

It is good practice to ensure that the AC neutral is at or near ground (earth) potential. A proper neutral will help ensure maximum performance from the instrument.

#### Wire Isolation

Four voltage levels of input and output wiring may be used with the unit:

1. Analogue input or output (for example thermocouple, RTD, VDC, mVDC or mADC)
2. Relays & Triac outputs
3. SSR Driver outputs
4. AC power

#### **CAUTION:**

**The only wires that should run together are those of the same category.**

If any wires need to run parallel with any other lines, maintain a minimum space of 150mm between them.

If wires MUST cross each other, ensure they do so at 90 degrees to minimise interference.



### Use of Shielded Cable

All analogue signals must use shielded cable. This will help eliminate electrical noise induction on the wires. Connection lead length must be kept as short as possible keeping the wires protected by the shielding. The shield should be grounded at one end only. The preferred grounding location is at the sensor, transmitter or transducer.

### Noise Suppression at Source

Usually when good wiring practices are followed, no further noise protection is necessary. Sometimes in severe electrical environments, the amount of noise is so great that it has to be suppressed at source. Many manufacturers of relays, contactors etc supply 'surge suppressors' which mount on the noise source. For those devices that do not have surge suppressors supplied, Resistance-Capacitance (RC) networks and/or Metal Oxide Varistors (MOV) may be added.

**Inductive coils:-** MOVs are recommended for transient suppression in inductive coils, connected in parallel and as close as possible to the coil. Additional protection may be provided by adding an RC network across the MOV.

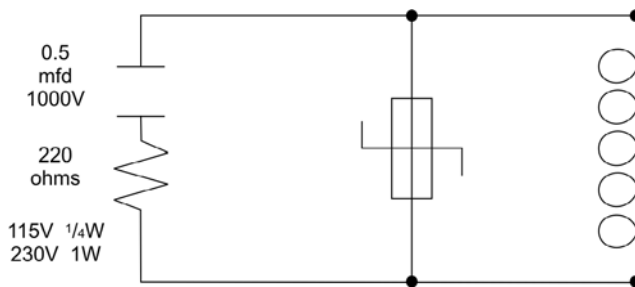

Figure 9. Transient suppression with inductive coils

**Contacts:-** Arcing may occur across contacts when they open and close. This results in electrical noise as well as damage to the contacts. Connecting a properly sized RC network can eliminate this arc.

For circuits up to 3 amps, a combination of a 47 ohm resistor and 0.1 microfarad capacitor (1000 volts) is recommended. For circuits from 3 to 5 amps, connect two of these in parallel.

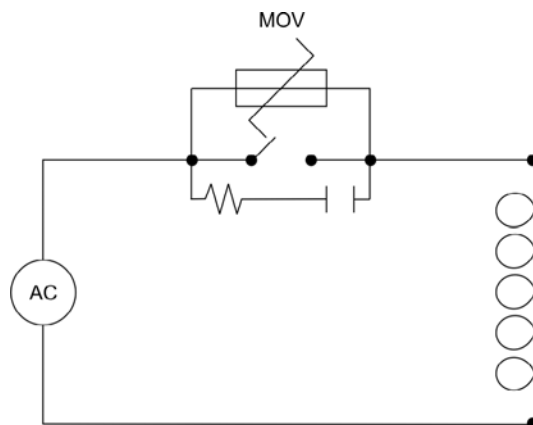

Figure 10. Contact noise suppression

### Sensor Placement (Thermocouple or RTD)

If the temperature probe is to be subjected to corrosive or abrasive conditions, it must be protected by an appropriate thermowell. The probe must be positioned to reflect true process temperature:

1. In a liquid media - the most agitated area
2. In air - the best circulated area

#### CAUTION:

**The placement of probes into pipe work some distance from the heating vessel leads to transport delay, which results in poor control.**

For a two wire RTD a wire link should be used in place of the third wire. Two wire RTDs must only be used with lead lengths less than 3 metres. Use of three wire RTDs is strongly recommended.

### Thermocouple Wire Identification Chart

The different thermocouple types are identified by their wires colour, and where possible, the outer insulation as well. There are several standards in use throughout the world.

The table below shows the wire and sheath colours used for most common thermocouple types. The format used in this table is:

+ Wire	Sheath
- Wire	

Table 2. Thermocouple Extension Wire Colours

Type		International IEC584-3	USA ANSI MC 96.1	British BS1843	French NFC 42-324	German DIN 43710
J	+*	Black Black	White Black	Yellow Black	Yellow Black	Red Blue
	-	White Black	Red Black	Blue Black	Black Black	Blue Blue
T	+	Brown Brown	Blue Blue	White Blue	Yellow Blue	Red Brown
	-	White Brown	Red Blue	Blue Blue	Blue Blue	Brown Brown
K	+	Green Green	Yellow Yellow	Brown Red	Yellow Yellow	Red Green
	-*	White Green	Red Yellow	Blue Red	Purple Yellow	Green Green
N	+	Pink Pink	Orange Orange	Orange Orange		
	-	White Pink	Red Orange	Blue Orange		
B	+	Grey Grey	Grey Grey			Red Grey
	-	White Grey	Red Grey			Grey Grey
R & S	+	Orange Orange	Black Green	White Green	Yellow Green	Red White
	-	White Orange	Red Green	Blue Green	Green Green	White White
C (W5)	+		White White			
	-		Red White			

#### Note:

\* = Wire is magnetic

### Connections and Wiring

The rear terminal connections for 1/16 DIN and 1/8 DIN instruments are illustrated in the following diagrams.

In general, all wiring connections are made to the instrument after it is installed. Copper wires must be used for all connections (except thermocouple signal wires).

**WARNING:**

**TO AVOID ELECTRICAL SHOCK, AC POWER WIRING MUST NOT BE CONNECTED TO THE SOURCE DISTRIBUTION PANEL UNTIL ALL WIRING PROCEDURES ARE COMPLETED.**

**WARNING:**

**CHECK THE INFORMATION LABEL ON THE CASE TO DETERMINE THE CORRECT VOLTAGE BEFORE CONNECTING TO A LIVE SUPPLY.**

**Note:**

*The wiring diagram below shows all possible combinations. The actual connections required depend upon the features available on the model and the modules and options fitted.*

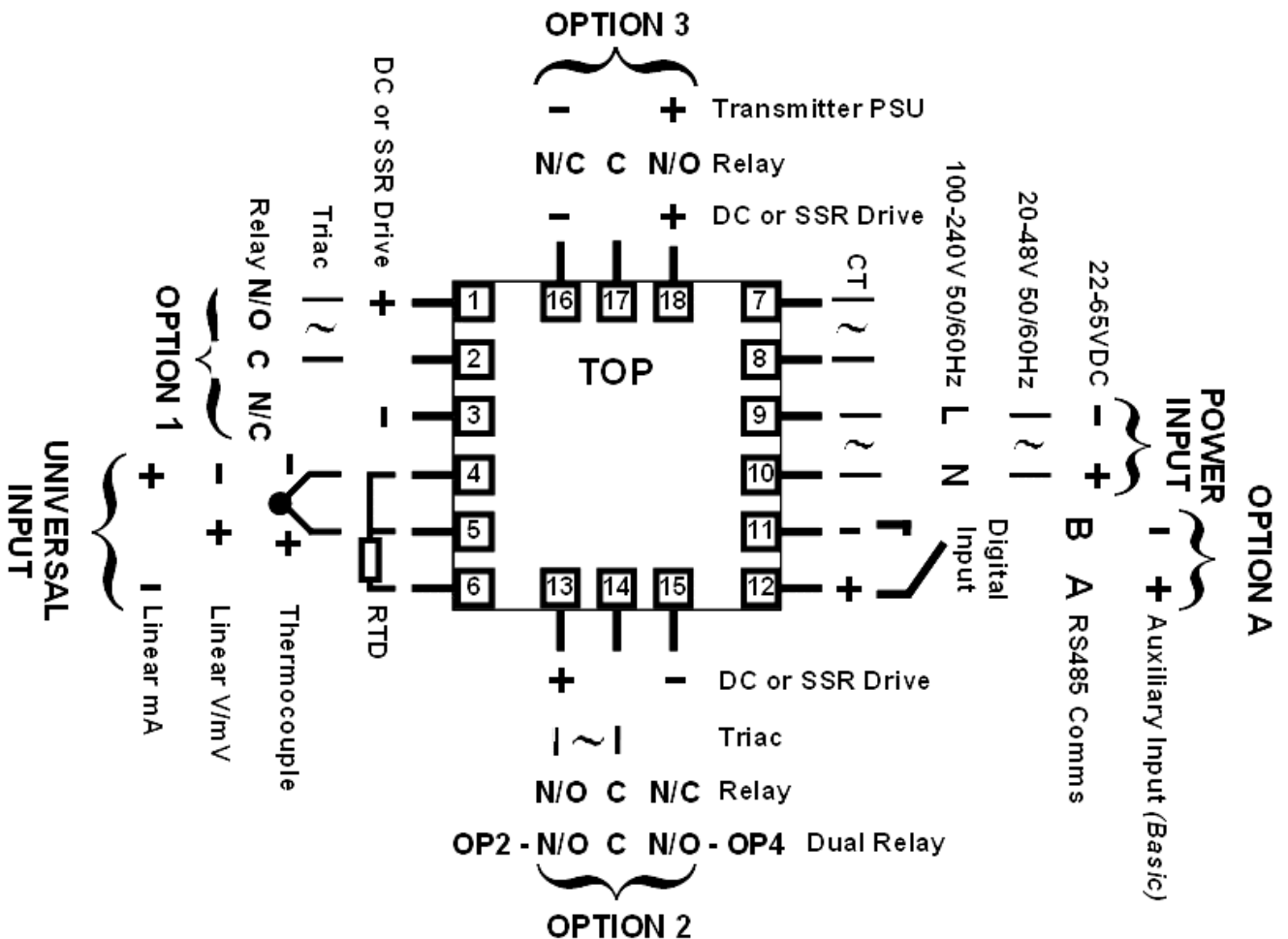

Figure 11. Rear terminals (1/16-DIN Instruments)

**WARNING:**

TO AVOID ELECTRICAL SHOCK, AC POWER WIRING MUST NOT BE CONNECTED TO THE SOURCE DISTRIBUTION PANEL UNTIL ALL WIRING PROCEDURES ARE COMPLETED.

**WARNING:**

CHECK THE INFORMATION LABEL ON THE CASE TO DETERMINE THE CORRECT VOLTAGE BEFORE CONNECTING TO A LIVE SUPPLY.

**Note:**

The wiring diagram below shows all possible combinations. The actual connections required depend upon the features available on the model and the modules and options fitted.

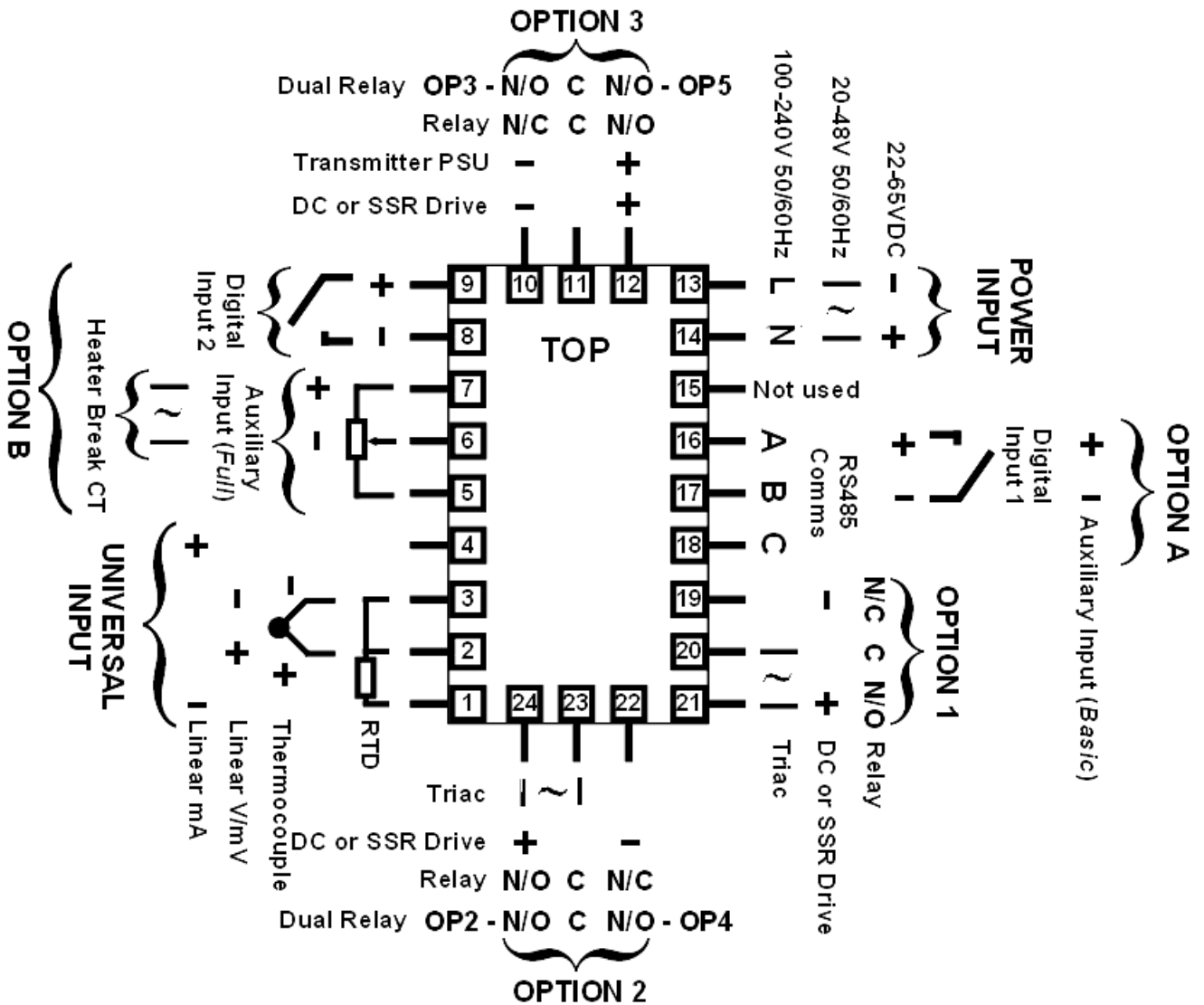

Figure 12. Rear terminals (1/8-DIN Instruments)

**Power Connections - Mains Powered Instruments**

Mains powered instruments operate from a 100 to 240V (±10%) 50/60Hz supply. Power consumption is 7.5VA. Connect the line voltage (live and neutral) as illustrated via a two-pole isolating switch (preferably located near the equipment) and a 1amp anti-surge fuse. If the instrument has relay outputs with contacts carrying mains voltage, it is recommended that the relay contacts supply should be switched and fused in a similar manner, but should be separate from the instruments mains supply.

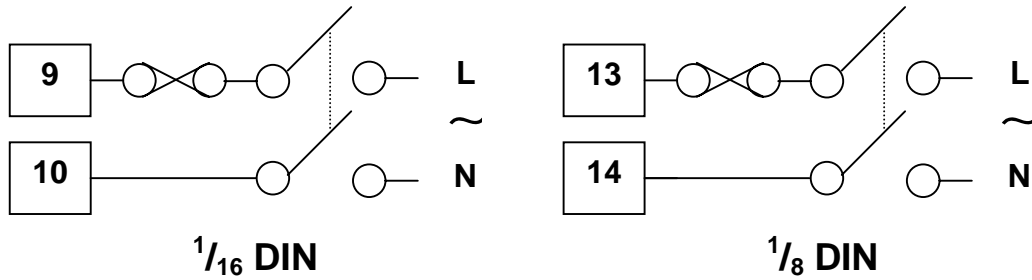

Figure 13. Mains Power Connections

**WARNING:**

**CHECK THE INFORMATION LABEL ON THE CASE TO DETERMINE THE CORRECT VOLTAGE BEFORE CONNECTING TO A LIVE SUPPLY.**

**CAUTION:**

**This equipment is designed for installation in an enclosure that provides adequate protection against electric shock**

**Power Connections - 24/48V AC/DC Powered Instruments**

24/48V AD/DC powered instruments will operate from a 20 to 48V AC or 22 to 55V DC supply. AC power consumption is 7.5VA max, DC power consumption is 5 watts max. Connection should be via a two-pole isolating switch (preferably located near the equipment) and a 315mA slow-blow (anti-surge type T) fuse.

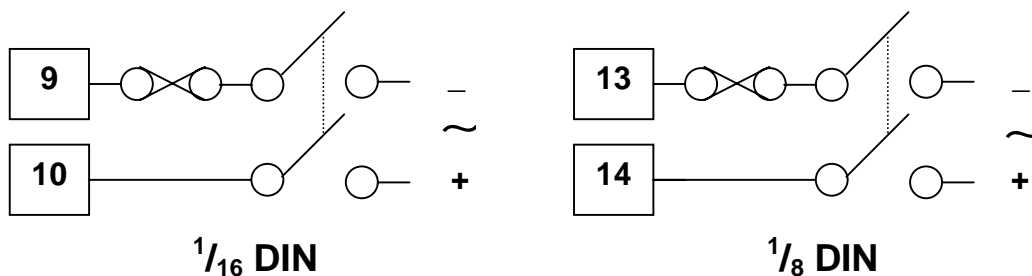

Figure 14. 24/48V AC/DC Power Connections

**WARNING:**

**CHECK THE INFORMATION LABEL ON THE CASE TO DETERMINE THE CORRECT VOLTAGE BEFORE CONNECTING TO A LIVE SUPPLY.**

### Universal Input Connections - Thermocouple (T/C)

Use only the correct thermocouple wire or compensating cable from the probe to the instrument terminals avoiding joints in the cable if possible. Failure to use the correct wire type will lead to inaccurate readings. Ensure correct polarity of the wires by cross-referencing the colours with a thermocouple reference table.



Figure 15. Thermocouple Input Connections

### Universal Input Connections – PT100 (RTD) input

For three wire RTDs, connect the resistive leg and the common legs of the RTD as illustrated. For a two wire RTD a wire link should be used in place of the third wire (shown by dotted line). Two wire RTDs should only be used when the leads are less than 3 metres long. Avoid cable joints.

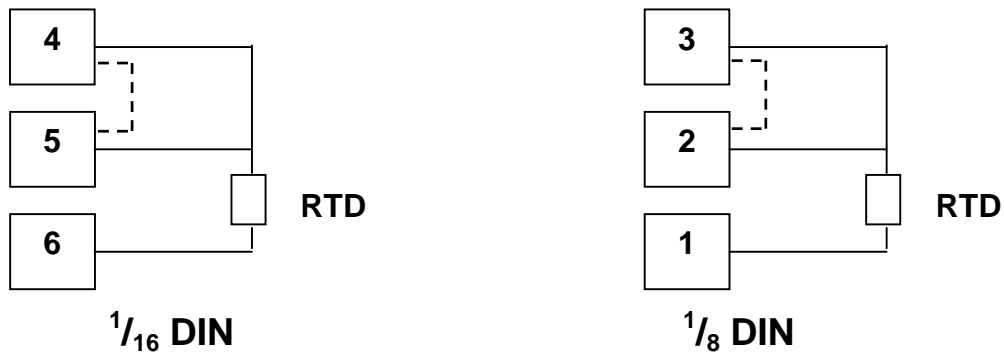

Figure 16. RTD Input Connections

Four wire RTDs can be used, provided that the fourth wire is left unconnected. This wire should be cut short or tied back so that it cannot contact any of the terminals on the rear of the instrument.

### Universal Input Connections - Linear Volt, mV or mA input

Linear DC voltage, millivolt or milliamp input connections are made as illustrated. Carefully observe the polarity of the connections.

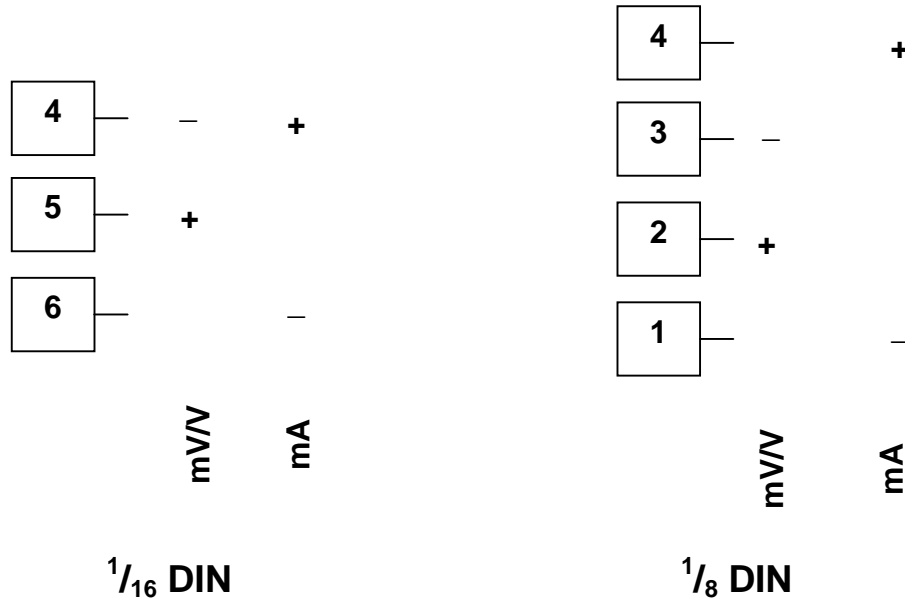

Figure 17. DC Volt, mV & mA Input Connections

### Option Slot 1 – Relay Output Module

If option slot 1 is fitted with a relay output module, make connections as illustrated. The relay contacts are rated at 2 amps resistive, 240 VAC (120V max for direct Valve Motor control).

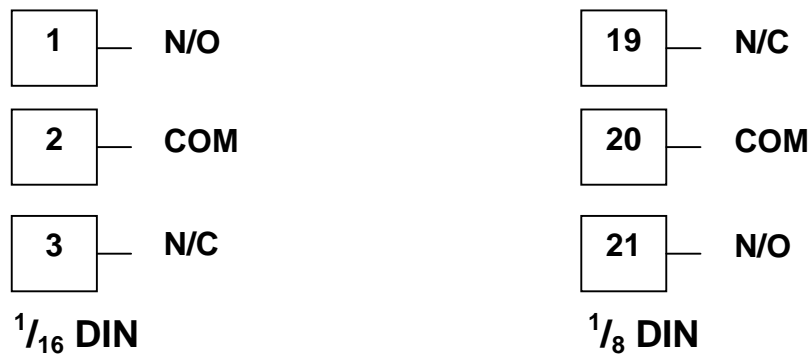

Figure 18. Option Slot 1 – Relay Module

### Option Slot 1 - SSR Driver Output Module

If option slot 1 is fitted with an SSR driver output module, make connections as illustrated. The solid-state relay driver is a 0-10V DC signal, load impedance must be no less than 500 ohms. SSR driver outputs are not isolated from the signal input or other SSR driver outputs.



Figure 19. Option Slot 1 - SSR Driver Module

### Option Slot 1 - Triac Output Module

If option slot 1 is fitted with a Triac output module, make connections as shown. This output is rated at 0.01 to 1 amp @ 280V AC 50/60Hz. (140V max for direct Valve Motor control).



Figure 20. Option Slot 1 - Triac Module

### Option Slot 1 - Linear Voltage or mADC Output module

If option slot 1 is fitted with a DC linear output module, make connections as illustrated.



Figure 21. Option Slot 1 - Linear Voltage & mADC Module



### Option Slot 2 - Relay Output Module

If option slot 2 is fitted with a relay output module, make connections as illustrated. The relay contacts are rated at 2 amps resistive, 240 VAC (120V max for direct Valve Motor control).



Figure 22. Option Slot 2 - Relay Module

### Option Slot 2 - SSR Driver Output Module

If option slot 2 is fitted with an SSR driver output module, make connections as illustrated. The solid-state relay driver is a 0-10V DC signal, load impedance must be no less than 500 ohms. SSR driver outputs are not isolated from the signal input or other SSR driver outputs.



Figure 23. Option Slot 2 - SSR Driver Module

### Option Slot 2 - Triac Output Module

If option slot 2 is fitted with a Triac output module, make connections as shown. This output is rated at 0.01 to 1 amp @ 280V AC 50/60Hz. (140V max for direct Valve Motor control).



Figure 24. Option Slot 2 - Triac Module

**WARNING:**

**THIS MODULE MUST NOT BE FITTED INTO OPTION SLOT 3.**

### Option Slot 2 - Dual Relay Output Module

If option slot 2 is fitted with a dual relay output module, make connections as illustrated. This module has two independent relays, which share a common connection terminal. The contacts are rated at 2 amp resistive 240 VAC. (120V max for direct Valve Motor control).

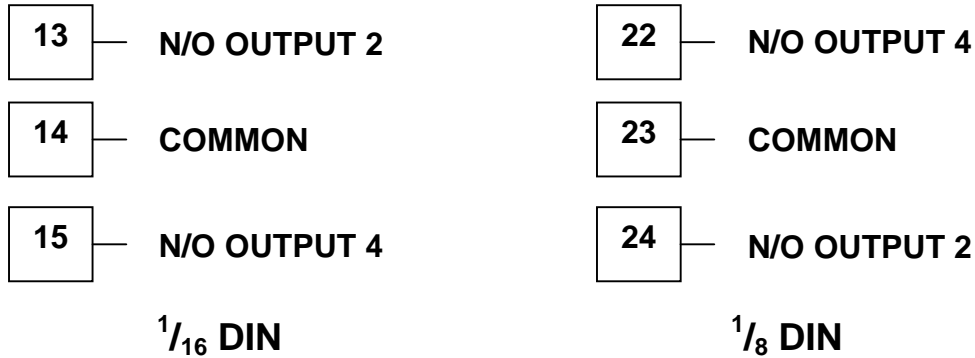

Figure 25. Option Slot 2 - Dual Relay Module

#### WARNING:

**THIS MODULE MUST NOT BE FITTED INTO OPTION SLOT 3 ON 1/16 DIN INSTRUMENTS.**

### Option Slot 2 - Linear Voltage or mADC Output module

If option slot 2 is fitted with a DC linear output module, make connections as illustrated.

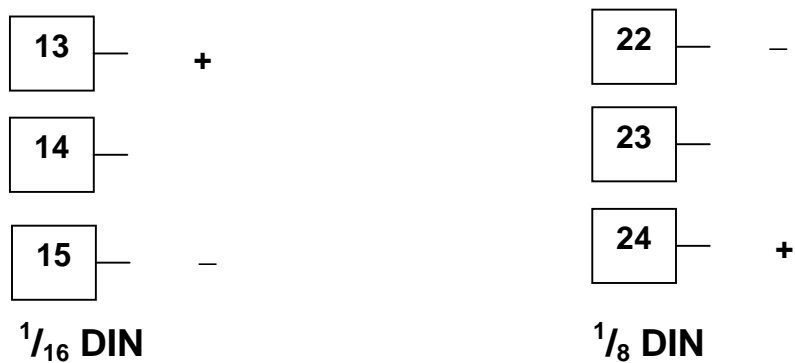

Figure 26. Option Slot 2 - Linear Voltage & mADC module

### Option Slot 3 - Relay Output Module

If option slot 3 is fitted with a relay output module, make connections as illustrated. The relay contacts are rated at 2 amps resistive, 240 VAC (120V max for direct Valve Motor control).



Figure 27. Option Slot 3 - Relay Module

### Option Slot 3 - SSR Driver Output Module

If option slot 3 is fitted with an SSR driver output module, make connections as illustrated. The solid-state relay driver is a 0-10V DC signal; load impedance must be no less than 500 ohms. SSR driver outputs are not isolated from the signal input or other SSR driver outputs.



Figure 28. Option Slot 3 - SSR Driver Module

### Option Slot 3 - Linear Voltage or mADC Output module

If option slot 3 is fitted with a DC linear output module, make connections as illustrated.

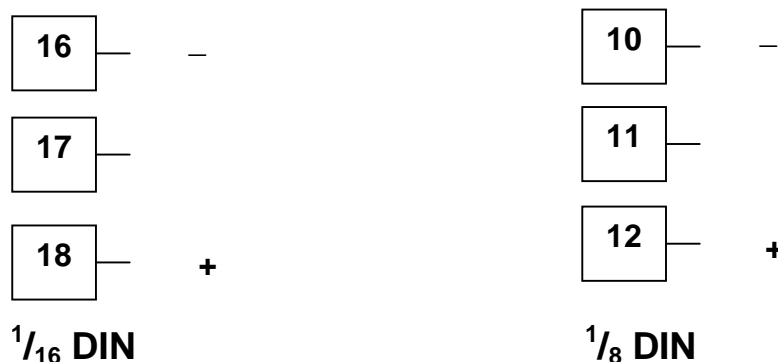

Figure 29. Option Slot 3 - Linear Voltage & mADC module

### Option Slot 3 - Dual Relay Output Module

If option slot 3 is fitted with a dual relay output module, make connections as illustrated. This module has two independent relays, which share a common connection terminal. The contacts are rated at 2 amp resistive 240 VAC. (120V max for direct Valve Motor control).

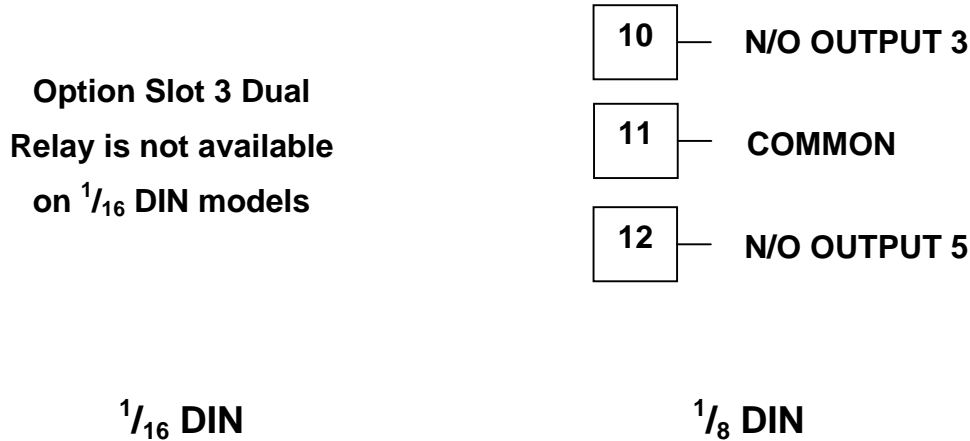

Figure 30. Option Slot 3 - Dual Relay Module

#### WARNING:

**THIS MODULE MUST NOT BE FITTED INTO OPTION SLOT 3 ON 1/16 DIN INSTRUMENTS.**

### Option Slot 3 - Transmitter Power Supply Module

If option slot 3 is fitted with a transmitter power supply module, make connections as illustrated. The output is an unregulated 24V DC, 22mA supply.



Figure 31. Option Slot 3 - Transmitter Power Supply Module

#### WARNING:

**THIS MODULE MUST NOT BE FITTED INTO OPTION SLOT 2.**

### Option Slot A Connections - RS485 Serial Communications Module

If option slot A is fitted with the RS485 serial communication module, connections are as illustrated. Carefully observe the polarity of the A (Rx/Tx +ve) and B (Rx/Tx -ve) connections.

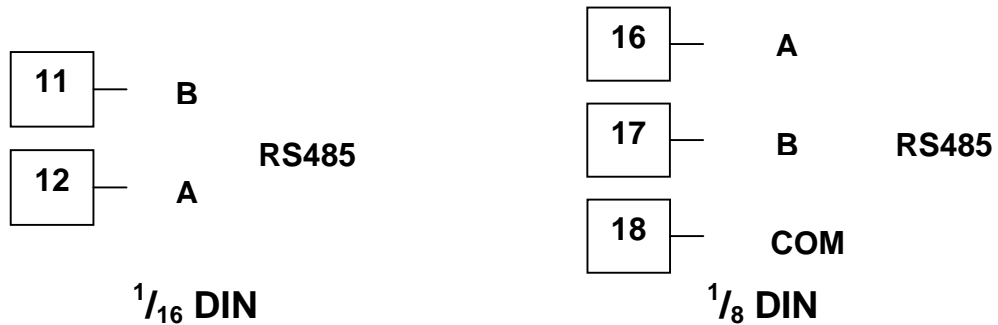

Figure 32. Option Slot A – RS485 Serial Communications Module

### Option Slot A Connections - Digital Input Module

If a digital input module is fitted in option slot A, this may be connected to either voltage free contacts (e.g. switch or relay), or a TTL compatible voltage. Connections are shown below.



Figure 33. Option Slot A – Digital Input Module

### Option Slot A Connections – Basic Auxiliary Input Module

If option slot A is fitted with a basic auxiliary input module, connect as shown. For 1/8-DIN models it is recommend that the full auxiliary input (Option Slot B) is used instead, as this has additional features and leaves option slot A free for other modules.



Figure 34. Option Slot A – Basic Auxiliary Input Module

**WARNING:**

**THIS MODULE MUST NOT BE FITTED IF FULL AUXILIARY INPUT IS FITTED IN OPTION SLOT B.**

### Option Slot B Connections – Digital Input 2 (Full Auxiliary Module)

If option slot B is fitted with the Full Auxiliary input module (see below), a secondary digital input is also provided. This may be connected to either the voltage free contacts of a switch or relay, or a TTL compatible voltage.

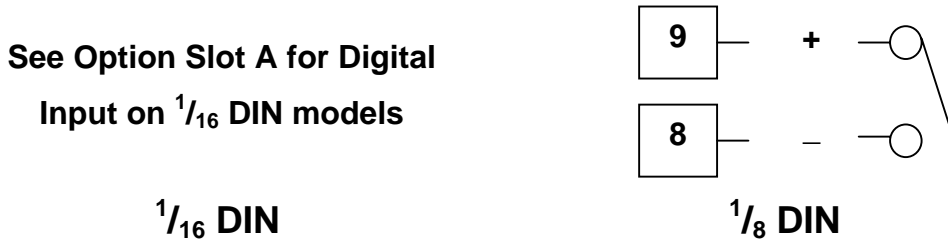

Figure 35. Option Slot B – Digital Input 2 Connections

### Option Slot B Connections – 1/8 DIN Full Auxiliary Input Module

If option slot B is fitted with full auxiliary input feature, input connections are as shown.

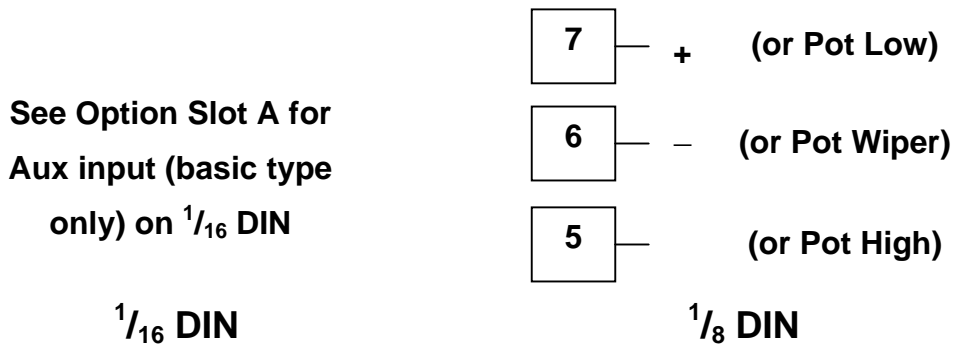

Figure 36. Option Slot B – Full Auxiliary Input Connections

#### WARNING:

**IF THE FULL AUXILIARY MODULE HAS BEEN FITTED, THE BASIC AUXILIARY INPUT MUST NOT BE FITTED INTO OPTION SLOT A.**

## 5 Powering Up

**WARNING:**

**ENSURE SAFE WIRING PRACTICES ARE FOLLOWED**

The instrument must be powered from a supply according to the wiring label on the side of the unit. The supply will be either 100 to 240V AC, or 24/48V AC/DC powered. Check carefully the supply voltage and connections before applying power.

**CAUTION:**

**When powering up for the first time, disconnect the output connections.**

### Powering Up Procedure

At power up, a self-test procedure is automatically started, during which all LED segments and indicators are lit. At the first power up from new, or if the option modules are changed, **Go to Conf** will be displayed, indicating configuration is required (refer to section 6). At all other times, the instrument returns to operator mode once the self-test procedure is complete.

### Overview Of Front Panel

The illustration below shows a typical instrument front panel. Refer to the following table – Typical LED functions for a description of the front panel indicators. Each model in the range will vary slightly from the example shown.



Figure 37. Typical front panel and keys

### Displays











Indicator models have a single line display, which normally shows the process variable value, and status indicators LED's for mode and alarm indication. Controllers are provided with a dual line display and LED indicators for mode, automatic tune, alarm and output status. The upper display shows the process variable value during normal operation, whilst the lower display shows the Setpoint value. See the preceding diagram - Typical front panel and keys.

### Keypad

Each instrument has either three or four switches, which are used to navigate through the user menus and make adjustment to the parameter values. See - Overview Of Front Panel above

### LED Functions

Table 3. Typical LED functions

LED	Function
	<b>ON</b> indicates the Setup Mode has been entered (This LED is labelled  on 1/8 Din indicators and  on Limit Controllers)
	<b>FLASHING</b> indicates the manual mode has been entered (On 1/8 Din indicators this LED is labelled  and flashes when in Configuration Mode )
	<b>ON</b> indicates that Controller Self Tune mode is engaged
	<b>FLASHING</b> indicates that Controller Pre-Tune mode is engaged
	<b>FLASHING</b> indicates that an alarm condition is present
	<b>FLASHES</b> in unison with Time Proportioning Primary outputs, or turns <b>ON</b> with Valve Motor “Open” outputs. For Current Proportioned outputs, <b>ON</b> indicates primary power is >0% It turns <b>ON</b> when the stored Max. PV value is displayed on indicators
	<b>FLASHES</b> in unison with Time Proportioning Secondary outputs, or turns <b>ON</b> with Valve Motor “Close” outputs. For Current Proportioned outputs, <b>ON</b> secondary power is >0% It turns <b>ON</b> when the stored Min. PV value is displayed on indicators



## 6 Messages and Error Indications

The following displays are shown when an error occurs or a hardware change is detected.

Table 4. Error/Faults conditions

Error/Faults Conditions	Upper display	Lower Display (where fitted)	DI1700 Units Display
Configuration & Setup is required. Seen at first turn on or if hardware configuration changed. Press <b>SETUP</b> to enter Configuration Mode, next press <b>▲</b> or <b>▼</b> to enter the unlock code number, then press <b>SETUP</b> to proceed. Configuration must be completed before return to operator mode is allowed <sup>1</sup>	<b>CoTo</b>  (CoTo for 1 second, then Conf on Indicators)	<b>ConF</b>	<b>C</b>
Input more than 5% over-range <sup>2</sup>	<b>[HH]*</b>	Normal Display	Normal Display
Input more than 5% under-range <sup>3</sup>	<b>[LL]*</b>	Normal Display	Normal Display
Sensor Break. Break detected in the input sensor or wiring	<b>OPEN*</b>	Normal Display	Normal Display
Auxiliary input over-range	Normal Display	<b>[HH]*</b>	n/a
Auxiliary input under-range	Normal Display	<b>[LL]*</b>	n/a
Auxiliary Break. Break detected in the auxiliary input	Normal Display	<b>OPEN*</b>	n/a
Option 1 module fault.	<b>Err**</b>	<b>OPn1</b>	<b>1</b>
Option 2 module fault.	<b>Err**</b>	<b>OPn2</b>	<b>2</b>
Option 3 module fault.	<b>Err**</b>	<b>OPn3</b>	<b>3</b>
Option A module fault.	<b>Err**</b>	<b>OPnA</b>	<b>A</b>
Option B module fault.	<b>Err</b>	<b>OPnb</b>	<b>b</b>

**\* Note**

*Input sensor and Auxiliary over/under-range or break indications will be seen wherever these values would normally be displayed.*

<sup>1</sup> This feature does not guarantee correct configuration. It only helps to ensure that the unit will be configured before use. Use of set-up mode is not enforced but may be essential for the users application.

<sup>2</sup> If the PV display exceeds **9999** before 5% over-range is reached, an over-range indication is given.

<sup>3</sup> Indicators will allow up to 10% under-range on non-zero based Linear ranges. If the PV display is less than **-1999** before the % under-range is reached, an under-range indication is given.

### 7 Instrument Operation Modes

All instruments in the range share a similar user interface. Indicator models (single 4-digit display) the legend shown in the “Lower Display” column will be shown for approx 1 second before the “Upper Display” value is shown. For more details, refer to the mode tables below.



Table 5. Model Groups

Model Group	Description	Model Group	Description
DC1200 & DC1700	Process Controllers	DC120T & DC170T	Valve Motor Controllers
DI1700	Indicator	DC120L	Limit Controller



#### Select Mode

This mode is used to gain entry to each of the modes available in the instrument.

#### Entry into the Select Mode

Hold down  and press  in any mode to force the unit to enter Select Mode.

#### Navigating in Select Mode

Once in Select Mode, press  or  to select the required mode, then press  to enter the chosen mode.

To prevent unauthorised entry to Configuration, Setup and Automatic Tuning modes, an unlock code is required. These are shown in the - Lock code values table.

Table 6. Select Mode Menus

Mode	Description	Upper/Main Display	Lower Display (or 1 <sup>st</sup> Legend)*	DI1700 Units Display
Operator Mode	The Default Mode on power up used for normal operation.	OPtr	SLCt	5
Set Up Mode	Used to tailor the instrument to the application, adjustment of tuning terms etc.	SEtP	SLCt	5
Configuration Mode	Used to configure the instrument for first time use or on re-installation.	ConF	SLCt	5
Product Information Mode	Used to check the hardware, firmware and manufacturing information of the instrument.	inFo	SLCt	5
Automatic Tune Mode	Used to invoke pre-tune or self-tune on controllers	Atun	SLCt	5

**\*Note:**

*On Indicators, this legend is shown for approx 1 second before the Main display value.*

### Unlock Codes

The **ULoc** screen is seen before entry is allowed to Configuration, Setup and Automatic Tuning modes.

An unlock code must be correctly selected using the or keys to enter the required mode. An incorrect entry results in a return to Select Mode. The value of the lock codes only can be changed from within the modes that they apply to.

Table 7. Lock Code – Entry and Default Values

Description	Upper/Main Display	Lower Display (or 1 <sup>st</sup> Legend)*	DI1700 Units Display
Default values are: Automatic Tune Mode = <b>0</b> Set-up mode = <b>10</b> Configuration Mode = <b>20</b> .	<b>0</b>	<b>ULoc</b>	<b>[</b>

**\*Note:**

*On DI1700 Indicatorss (single line display), this legend is shown for approx 1 second before the Main display value.*

### Automatic Tune Mode

Automatic Tune Mode is selected when it is desired to use the Pre-tune and Self-tune facilities on a controller to assist the user in setting up Proportional band, Integral and Derivative parameter values. Refer to the following Automatic Tune Mode table.

Pre-tune can be used to set Controller PID parameters approximately. Self-tune may then be used to optimise the tuning. Pre-tune can be set to run automatically after every power-up using the Auto Pre-Tune **APt** parameter in Setup Mode.

The **AT** indicator will flash while pre-tune is operating, and is continuously on whilst Self-tune is operating. If both Pre-tune and Self-tune are engaged the **AT** indicator will flash until Pre-tune is finished, and is then continuously on.

### Navigating in Automatic Tune Mode

Press to select the next parameter in the table and or to set the value required.

Hold down and press to return to Select Mode.

**Note:**

*If there is no key activity for 2 minutes the controller automatically returns to operator mode*

Table 8. Automatic Tune Mode Parameters

Parameter	Upper Display Adjustment Range	Lower Display	Default Value	When Visible
Pre-tune	<b>On</b> or <b>OFF</b> . Indication remains <b>OFF</b> if Pre-Tune cannot be used at this time. This applies if: a). The setpoint is ramping b). The process variable is less than 5% of span from the setpoint c). The primary or secondary output proportional bands = 0	<b>Ptun</b>	<b>OFF</b>	Controller models only
Self-tune	<b>On</b> or <b>OFF</b> . Indication remains <b>OFF</b> if Self-Tune cannot be used at this time. This applies if either proportional band = 0.	<b>Stun</b>	<b>OFF</b>	Controller models only
Automatic tune mode lock code	0 to 9999	<b>tLoc</b>	<b>0</b>	Controller models only

### Product Information Mode

This is a read only mode describing the instrument and the options fitted to it.

#### Navigating in the Product Information Mode

Press **SETUP** to view each parameter in turn.

Hold Down **SETUP** and press **▲** to return to Select Mode.

#### Note:

*If there is no key activity for 2 minutes the controller automatically returns to operator mode*

Table 9. Product Information Mode Parameters

Parameter	Possible Values	Upper/Main Display	Lower Display (or 1 <sup>st</sup> Legend)*	DI1700 Units Display
Input type	Universal input	<b>Un I</b>	<b>In I</b>	<b>t</b>
Option 1 module type	No option fitted	<b>nonE</b>	<b>OPn I</b>	<b>I</b>
	Relay	<b>rLY</b>		
	SSR drive	<b>SSr</b>		
	Triac	<b>tr I</b>		
	Linear voltage / current output	<b>L in</b>		

Parameter	Possible Values	Upper/Main Display	Lower Display (or 1 <sup>st</sup> Legend)*	DI1700 Units Display
Option 2 module type	No option fitted.	nonE	OPn2	2
	Relay	rLY		
	Dual relay	drLY		
	SSR drive	SSr		
	Triac	tr ,		
	Linear voltage / current output	L in		
Option 3 module type	No option fitted.	nonE	OPn3	3
	Relay	drLY		
	Dual relay	rLY		
	SSR drive	SSr		
	Linear voltage / current output	L in		
	24V Transmitter power supply	dc24		
Auxiliary option A module type	No option fitted	nonE	OPnA	A
	RS485 comms	r485		
	Digital input	dIG ,		
	Basic Auxiliary input	rSP ,		
Auxiliary option B module type	No option fitted	nonE	OPnb	Not Applicable
	Full Auxiliary input and digital input 2	rSP ,		
Firmware	Value displayed is firmware type number		FLW	F
Issue No.	Value displayed is firmware issue number		ISS	n
Product Rev Level	Value displayed is Product Revision Level.		PRL	r
Date of manufacture	Manufacturing date code (mmyy)		d077	d
Serial number 1	First four digits of serial number		Sn1	A
Serial number 2	Second four digits of serial number		Sn2	b
Serial number 3	Last four digits of serial number		Sn3	c



**\*Note:**

*DI1700 Indicators (which have a single line display), this legend is shown for approx 1 second before the Main display value.*

### Lock Code View

In the event that a lock code is forgotten, the instrument lock code values can be seen in the lock code view. In this view the codes are read only, the codes can be changed from the mode to which they apply.

### Entry and Navigating in Lock Code View Mode

Press  and  together whilst the instrument is powering up until the **CLoc** display is shown.

Once in this mode

Press  to step between lock codes.

**Note:**

*If there is no key activity for 2 minutes the instrument returns to Operator Mode. To forcefully exit this view, switch off the instrument.*

Table 10. Lock Code View Menu

Lock Code Name	Description	Upper/Main Display	Lower Display (or 1 <sup>st</sup> Legend)*	DI1700 Units Display
Configuration Lock Code	Read only view of Configuration Lock Code.	Current Value	<b>CLoc</b>	<b>C</b>
Setup Lock Code	Read only view of Setup Mode Lock Code.	Current Value	<b>SLoc</b>	<b>S</b>
Automatic Tune Lock Code	Read only view of Automatic Tune Lock Code.	Current Value	<b>tLoc</b>	

**\*Note:**

*On DI1700 Indicators (which have a single line display), this legend is shown for approx 1 second before the Main display value.*

## 8 DC1200 & DC1700 Controller – Model Group

These controllers combine technical functionality, field flexibility and ease of use to give you the best in comprehensive process control. The DC1200 1/16 -DIN Controller (48 x 48mm) and DC1700 1/8 -DIN Controller (96 x 48mm) offer similar functionality in two DIN sizes.

Heat/Cool operation	Loop alarm
Auto/Manual Tuning	Remote or Dual setpoint selection options
Two process alarms	RS485 Modbus and ASCII comms option
Ramping setpoint	PC configuration option

### DC1200 & DC1700 Controllers - Configuration Mode

This mode is normally used only when the instrument is configured for the first time or when a major change is made to the instruments characteristics. The Configuration Mode parameters must be set as required before adjusting parameters in Setup Mode, or attempting to use the instrument in an application.

#### Entry into the Configuration Mode

##### **CAUTION:**

**Adjustments to these parameters should only be performed by personnel competent and authorised to do so.**

Configuration is entered from Select Mode

Hold down  and press  to force the controller into the Select Mode.

then

Press  or  to navigate to the Configuration Mode option, then press .

##### **Note:**

*Entry into this mode is security-protected by the Configuration Mode Lock Code. Refer to the Unlock Code section for more details.*

#### Scrolling through Parameters and Values

Press  to scroll through the parameters (parameters are described below).

##### **Note:**

*Only parameters that are applicable to the hardware options chosen will be displayed.*

### Changing Parameter Values

Press **SETUP** to navigate to the required parameter, then press **▲** or **▼** to set the value as required.

Once the value is changed, the display will flash to indicate that confirmation of the change is required. The value will revert back if not confirmed within 10 seconds.

Press **Man Auto** to accept the change.

Or

Press **SETUP** to reject the change and to move onto the next parameter.

Hold down **SETUP** and press **▲** to return to Select Mode.

#### Note:

*If there is no key activity for 2 minutes the instrument returns to the operator mode.*

Table 11. DC1200 & DC1700 Configuration Mode Parameters

Parameter	Lower Display	Upper Display	Description	Default Value	When Visible
Input type and Range	InPt	bC	B type: 100 to 1824 °C	J <b>C</b> for Europe	Always
		bF	B type: 211 to 3315 °F		
		C <b>C</b>	C type: 0 to 2320 °C	J <b>F</b> for USA	
		C <b>F</b>	C type: 32 to 4208 °F		
		J <b>C</b>	J type: -200 to 1200 °C		
		J <b>F</b>	J type: -328 to 2192 °F		
		J. <b>C</b>	J type: -128.8 to 537.7 °C with decimal point		
		J. <b>F</b>	J type: -199.9 to 999.9 °F with decimal point		
		K <b>C</b>	K type: -240 to 1373 °C		
		K <b>F</b>	K type: -400 to 2503 °F		
		K. <b>C</b>	K type: -128.8 to 537.7 °C with decimal point		
		K. <b>F</b>	K type: -199.9 to 999.9 °F with decimal point		
		L <b>C</b>	L type: 0 to 762 °C		
		L <b>F</b>	L type: 32 to 1403 °F		
		L. <b>C</b>	L type: 0.0 to 537.7 °C with decimal point		
		L. <b>F</b>	L type: 32.0 to 999.9 °F with decimal point		



Parameter	Lower Display	Upper Display	Description	Default Value	When Visible
Input type and Range (continued)		nC	N type: 0 to 1399 °C	<b>JC</b> for Europe  <b>JF</b> for USA	Always
		nF	N type: 32 to 2551 °F		
		rC	R type: 0 to 1759 °C		
		rF	R type: 32 to 3198 °F		
		sC	S type: 0 to 1762 °C		
		sF	S type: 32 to 3204 °F		
		tC	T type: -240 to 400 °C		
		tF	T type: -400 to 752 °F		
		t.C	T type: -128.8 to 400.0 °C with decimal point		
		t.F	T type: -199.9 to 752.0 °F with decimal point		
		P24C	PtRh20% vs PtRh40%: 0 to 1850 °C		
		P24F	PtRh20% vs PtRh40%: 32 to 3362 °F		
Input type and Range (Continued)	InPt	PtC	Pt100: -199 to 800 °C	<b>JC</b> for Europe  <b>JF</b> for USA	Always
		PtF	Pt100: -328 to 1472 °F		
		Pt.C	Pt100: -128.8 to 537.7 °C with decimal point		
		Pt.F	Pt100: -199.9 to 999.9 °F with decimal point		
		0_20	0 to 20mA DC		
		4_20	4 to 20mA DC		
		0_50	0 to 50mV DC		
		10_50	10 to 50mV DC		
		0_5	0 to 5V DC		
		1_5	1 to 5V DC		
		0_10	0 to 10V DC		
		2_10	2 to 10V DC		
Scale Range Upper Limit	rUL	Scale Range Lower Limit +100 to Range Max		Linear inputs = 1000 (°C/°F inputs = max range)	Always
Scale Range Lower Limit	rLL	Range Min. to Scale range Upper Limit - 100		Linear = 0 (°C/°F = min range)	Always

Parameter	Lower Display	Upper Display	Description	Default Value	When Visible
Decimal point position	<b>dPo5</b>	<b>0</b>	Decimal point position in non-temperature ranges. 0 = <b>XXXX</b> 1 = <b>XXX.X</b> 2 = <b>XX.XX</b> 3 = <b>X.XXX</b>	<b>1</b>	<b>InPt</b> = mV, V or mA
		<b>1</b>			
		<b>2</b>			
		<b>3</b>			
Control Type	<b>CtYP</b>	<b>SnGL</b>	Primary control	<b>SnGL</b>	Always
		<b>duAL</b>	Primary and Secondary control (e.g. for heat & cool)		
Primary Output Control Action	<b>CtrL</b>	<b>rEu</b>	Reverse Acting	<b>rEu</b>	Always
		<b>dir</b>	Direct Acting		
Alarm 1 Type	<b>ALR1</b>	<b>P_H1</b>	Process High Alarm	<b>P_H1</b>	Always
		<b>P_Lo</b>	Process Low Alarm		
		<b>dE</b>	Deviation Alarm		
		<b>bAnd</b>	Band Alarm		
		<b>nonE</b>	No alarm		
Process High Alarm 1 value*	<b>PhR1</b>	Range Min. to Range Max. <i>Parameter repeated in Setup Mode</i>		Range Max.	<b>ALR1</b> = <b>P_H1</b>
Process Low Alarm 1 value*	<b>PLR1</b>	Range Min. to Range Max. <i>Parameter repeated in Setup Mode</i>		Range Min.	<b>ALR1</b> = <b>P_Lo</b>
Deviation Alarm 1 Value*	<b>dAL1</b>	$\pm$ span from setpoint <i>Parameter repeated in Setup Mode</i>		<b>5</b>	<b>ALR1</b> = <b>dE</b>
Band Alarm 1 value*	<b>bAL1</b>	1 LSD to full span from setpoint. <i>Parameter repeated in Setup Mode</i>		<b>5</b>	<b>ALR1</b> = <b>bAnd</b>
Alarm 1 Hysteresis*	<b>AHY1</b>	1 LSD to 100% of span (in display units) on "safe" side of alarm point. <i>Parameter repeated in Setup Mode</i>		<b>1</b>	Always
Alarm 2 Type	<b>ALR2</b>	As for alarm 1 type		<b>P_Lo</b>	Always
Process High Alarm 2 value*	<b>PhR2</b>	Range Min. to Range Max. <i>Parameter repeated in Setup Mode</i>		Range Max.	<b>ALR2</b> = <b>P_H1</b>
Process Low Alarm 2 value*	<b>PLR2</b>	Range Min. to Range Max. <i>Parameter repeated in Setup Mode</i>		Range Min.	<b>ALR2</b> = <b>P_Lo</b>
Deviation Alarm 2 Value*	<b>dAL2</b>	$\pm$ span from setpoint. <i>Parameter repeated in Setup Mode</i>		<b>5</b>	<b>ALR2</b> = <b>dE</b>
Band Alarm 2 value*	<b>bAL2</b>	1 LSD to full span from setpoint. <i>Parameter repeated in Setup Mode</i>		<b>5</b>	<b>ALR2</b> = <b>bAnd</b>
Alarm 2 Hysteresis*	<b>AHY2</b>	1 LSD to 100% of span (in display units) on "safe" side of alarm point. <i>Parameter repeated in Setup Mode</i>		<b>1</b>	Always
Loop Alarm Enable	<b>LAEn</b>	<b>dISA</b> (disabled) or <b>EnAb</b> (enabled)		<b>dISA</b>	Always

Parameter	Lower Display	Upper Display	Description	Default Value	When Visible
Loop Alarm Time*	<i>LAt</i>		1 sec to 99 mins. 59secs Only applies if primary proportional band = 0	<b>99.59</b>	<i>LAE<sub>n</sub></i> = <i>EnAb</i>
Alarm Inhibit	<i>inh</i>	<i>nonE</i>	No alarms inhibited	<b>nonE</b>	Always
		<i>AL1</i>	Alarm 1 inhibited		
		<i>AL2</i>	Alarm 2 inhibited		
		<i>both</i>	Alarm 1 and alarm 2 inhibited		
Output 1 Usage	<i>USE 1</i>	<i>Pr</i>	Primary Power	<b>Pr</b>	<i>OPn 1</i> is not <b>nonE</b>
		<i>SEc</i>	Secondary Power		<i>Not linear</i>
		<i>A1_d</i>	Alarm 1, Direct Acting		<i>Not linear</i>
		<i>A1_r</i>	Alarm 1, Reverse Acting		<i>Not linear</i>
		<i>A2_d</i>	Alarm 2, Direct Acting		<i>Not linear</i>
		<i>A2_r</i>	Alarm 2, Reverse Acting		<i>Not linear</i>
		<i>LP_d</i>	Loop Alarm, Direct Acting		<i>Not linear</i>
		<i>LP_r</i>	Loop Alarm, Reverse Acting		<i>Not linear</i>
		<i>Or_d</i>	Logical Alarm 1 OR Alarm 2 Direct Acting		<i>Not linear</i>
		<i>Or_r</i>	Logical Alarm 1 OR Alarm 2 Reverse Acting		<i>Not linear</i>
		<i>Ar_d</i>	Logical Alarm 1 AND Alarm 2, Direct Acting		<i>Not linear</i>
		<i>Ar_r</i>	Logical Alarm 1 AND Alarm 2, Reverse Acting		<i>Not linear</i>
		<i>rEtS</i>	Retransmit SP Output		<i>Linear only</i>
		<i>rEtP</i>	Retransmit PV Output		<i>Linear only</i>
Linear Output 1 Range	<i>tYP 1</i>	<i>0_5</i>	0 to 5 V DC output 1	<b>0_10</b>	<i>OPn 1</i> = <i>L in</i>
		<i>0_10</i>	0 to 10 V DC output		
		<i>2_10</i>	2 to 10 V DC output		
		<i>0_20</i>	0 to 20 mA DC output		
		<i>4_20</i>	4 to 20 mA DC output		
Retransmit Output 1 Scale maximum	<i>ro IH</i>	<b>- 1999 to 9999</b> Display value at which output will be maximum	Range max	<i>USE 1</i> = <i>rEtS</i> or <i>rEtP</i>	
Retransmit Output 1 Scale minimum	<i>ro IL</i>	<b>- 1999 to 9999</b> Display value at which output will be minimum	Range min	<i>USE 1</i> = <i>rEtS</i> or <i>rEtP</i>	

Parameter	Lower Display	Upper Display	Description	Default Value	When Visible
Output 2 Usage	USE2	As for output 1		SEc if dual control selected else R2_d	OPn2 is not nonE
Linear Output 2 Range	tYP2	As for output 1		0_10	OPn2 = Lin
Retransmit Output 2 Scale maximum	ro2H	- 1999 to 9999 Display value at which output will be maximum		Range max	USE2 = rEtS or rEtP
Retransmit Output 2 Scale minimum	ro2L	- 1999 to 9999 Display value at which output will be minimum		Range min	USE2 = rEtS or rEtP
Output 3 Usage	USE3	As for output 1		R1_d	OPn3 is not nonE
Linear Output 3 Range	tYP3	As for output 1		0_10	OPn3 = Lin
Retransmit Output 3 Scale maximum	ro3H	- 1999 to 9999 Display value at which output will be maximum		Range max	USE3 = rEtS or rEtP
Retransmit Output 3 Scale minimum	ro3L	- 1999 to 9999 Display value at which output will be minimum		Range min	USE3 = rEtS or rEtP
Display Strategy	dISP	1, 2, 3, 4, 5 or 6 (see Operator Mode)		1	Always
Comms Protocol	Prot	ASC1	ASCII	r7bn	OPnA = r4B5
		r7bn	Modbus with no parity		
		r7bE	Modbus with Even Parity		
		r7bo	Modbus with Odd Parity		
Bit rate	bAud	1.2	1.2 kbps	4.8	OPnA = r4B5
		2.4	2.4 kbps		
		4.8	4.8 kbps		
		9.6	9.6 kbps		
		19.2	19.2 kbps		
Communications Address	Addr	1	Unique address assigned to the instrument in the range of 1 to 255 (Modbus), 1 to 99 (Ascii)	1	OPnA = r4B5

Parameter	Lower Display	Upper Display	Description	Default Value	When Visible
Communications Write Enable	CoEn	r_o	Read only. Comms writes ignored	r_w	Always
		r_w	Read / Write. Writing via Comms is possible		
Digital Input 1 Usage	d_i1	d_s1	Setpoint 1 / Setpoint 2 Select**	d_s1	OPnA = d_i1
		d_rS	Automatic / Manual Select**		
Digital Input 2 Usage	d_i2	d_s1	Setpoint 1 / Setpoint 2 Select**	d_rS	OPnb = rSP1
		d_rS	Automatic / Manual Select**		
		d_rS	Remote / Local Setpoint Select		
Remote Setpoint Input Range	r_inP	0_20	0 to 20mA DC input	0_10	OPnA or OPnb = rSP1
		4_20	4 to 20mA DC input		
		0_10	0 to 10V DC input		
		2_10	2 to 10V DC input		
		0_5	0 to 5V DC input		
		1_5	1 to 5V DC input		
		100	0 to 100mV DC input		
		Pot	Potentiometer (≥2KΩ)		OPnb = rSP1
Remote Setpoint Upper Limit	rSPu	- 1999 to 9999 RSP value to be used when RSP input is at maximum.	Range max	OPnA = rSP1	
Remote Setpoint Lower Limit	rSPl	- 1999 to 9999 RSP value to be used when RSP input is at minimum.	Range min	OPnA = rSP1	
Remote Setpoint Offset	rSPo	Offset applied to RSP value. Constrained within Scale Range Upper Limit and Scale Range Lower Limit.	0	OPnA = rSP1	
Configuration Mode Lock Code	CLoc	0 to 9999	20	Always	

**\*Note:**

Alarm parameters marked \* are repeated in Setup Mode.

**\*\*Note:**

If d\_i1 or d\_i2 = d\_s1 the remote setpoint input feature is disabled. The instrument uses the two internal setpoints (SP1 & SP2) instead.

If d\_i1 and d\_i2 are set to the same value, the status of digital input 2 will take precedence over digital input 1.

### DC1200 & DC1700 – Setup Mode

This mode is normally selected only after Configuration Mode has been completed, and is used when a change to the process set up is required. It can affect the range of adjustments available in Operator Mode. Using the PC Configurator software, it is possible to configure an Extended Operator Mode. Setup Mode parameters are moved into Operator Mode, and these parameters appear after the normal Operator Mode screen sequence has been completed.

**Note:**

*Entry into Setup Mode is security-protected by the Setup Mode lock code.*

#### Entry into the Setup Mode



Hold down  and press  to enter the Select Mode

Press  or  to navigate to the Setup Mode option, then press  to enter Setup Mode.

#### Scrolling through Parameters & Values

Press  to scroll through the parameters (refer to the table below) and their values.

#### Changing Parameter Values

Press  to select the required parameter, then press  or  to set the value as required.

Once the displayed value is changed the effect is immediate. No confirmation of the change is required.

**Note:**

*If there is no key activity for two minutes the instrument returns to the operator mode.*

Table 12. DC1200 & DC1700 Set Up Mode Parameters

Parameter	Lower Display	Upper Display Adjustment Range	Default Value	When Visible
Input Filter Time constant	<b>FILT</b>	OFF, 0.5 to 100.0 secs in 0.5 sec increments	<b>2.0</b>	Always
Process Variable Offset	<b>OFFS</b>	±Span of controller	<b>0</b>	Always
Primary Power	<b>PPUJ</b>	The current Primary Output Power. Read Only.	N/A	Always
Secondary Power	<b>SPUJ</b>	The current Secondary Output power. Read Only.	N/A	<b>CTYP = dUAL</b>
Primary Output Proportional Band	<b>Pb_P</b>	0.0% (ON/OFF control) and 0.5% to 999.9% of input span.	<b>10.0</b>	Always
Secondary Output Proportional Band	<b>Pb_S</b>	0.0% (ON/OFF control) and 0.5% to 999.9% of input span.	<b>10.0</b>	<b>CTYP = dUAL</b>
Automatic Reset (Integral Time Constant)	<b>ARSt</b>	0.01 to 99.59 (1 sec to 99 mins 59 secs) and OFF	<b>5.00</b>	<b>Pb_P</b> is not <b>0.0</b>
Rate (Derivative Time Constant)	<b>rAtE</b>	0.00 to 99.59 (OFF to 99 mins 59 secs)	<b>1.15</b>	<b>Pb_P</b> is not <b>0.0</b>
Overlap/Deadband	<b>OL</b>	-20% to +20% of the sum of the Primary and Secondary Proportional Bands	<b>0</b>	<b>Pb_P</b> is not <b>0.0</b>
Manual Reset (Bias)	<b>bIAS</b>	0% to 100% (-100% to 100% if <b>CTYP = dUAL</b> )	<b>25</b>	<b>Pb_P</b> is not <b>0.0</b>
Primary Output ON/OFF Differential	<b>dIFP</b>	0.1% to 10.0% of input span (enter in % span)	<b>0.5</b>	<b>Pb_P = 0.0</b>
Secondary Output ON/OFF Differential	<b>dIFS</b>	0.1% to 10.0% of input span (enter in % span)	<b>0.5</b>	<b>Pb_S = 0.0</b>
Primary and Secondary Output ON/OFF Differential	<b>dIFF</b>	0.1% to 10.0% of input span (enter in % span)	<b>0.5</b>	<b>Pb_P</b> and <b>Pb_S = 0.0</b>
Setpoint Upper Limit	<b>SPUL</b>	Current Setpoint value to Scale Range Maximum	Range Max.	Always
Setpoint Lower limit	<b>SPLL</b>	Scale Range Minimum to current Setpoint value	Range Min	Always
Primary (Heat) Output Upper Power Limit	<b>OPUL</b>	0% to 100% of full power	<b>100</b>	<b>Pb_P</b> is not <b>0.0</b>
Output 1 Cycle Time	<b>CTI</b>	0.5, 1, 2, 4, 8, 16, 32, 64, 128, 256 or 512 secs. Not applicable to linear outputs	<b>32</b>	<b>USE I = Pr,</b> or <b>SEc</b> or <b>buS</b>



Parameter	Lower Display	Upper Display Adjustment Range	Default Value	When Visible
Output 2 Cycle Time	<b>Ct2</b>	0.5, 1, 2, 4, 8, 16, 32, 64, 128, 256 or 512 secs. Not applicable to linear outputs	<b>32</b>	<b>USE2 = Pr ,</b> or <b>SEc</b> or <b>buS</b>
Output 3 Cycle Time	<b>Ct3</b>	0.5, 1, 2, 4, 8, 16, 32, 64, 128, 256 or 512 secs. Not applicable to linear outputs	<b>32</b>	<b>USE3 = Pr ,</b> or <b>SEc</b> or <b>buS</b>
Process High Alarm 1 value*	<b>PHR1</b>	Range Min. to Range Max.	Range Max.	<b>ALA1 = P_H ,</b>
Process Low Alarm 1 value*	<b>PLR1</b>	Range Min. to Range Max.	Range Min.	<b>ALA1 = P_Lo</b>
Deviation Alarm 1 Value*	<b>dAL1</b>	±span from setpoint	<b>5</b>	<b>ALA1 = dE</b>
Band Alarm 1 value*	<b>bAL1</b>	1 LSD to full span from setpoint.	<b>5</b>	<b>ALA1 = bAnd</b>
Alarm 1 Hysteresis*	<b>AHY1</b>	Up to 100% of span	<b>1</b>	Always
Process High Alarm 2 value*	<b>PHR2</b>	Range Min. to Range Max.	Range Max.	<b>ALA2 = P_H ,</b>
Process Low Alarm 2 value*	<b>PLR2</b>	Range Min. to Range Max.	Range Min.	<b>ALA2 = P_Lo</b>
Deviation Alarm 2 Value	<b>dAL2</b>	±span from setpoint	<b>5</b>	<b>ALA2 = dE</b>
Band Alarm 2 value*	<b>bAL2</b>	1 LSD to full span from setpoint.	<b>5</b>	<b>ALA2 = bAnd</b>
Alarm 2 Hysteresis*	<b>AHY2</b>	Up to 100% of span	<b>1</b>	Always
Loop Alarm Time*	<b>LAte ,</b>	1 sec to 99 mins. 59secs. Only applies if primary proportional band = 0	<b>99 .59</b>	<b>LAEn = EnAb</b>
Auto Pre-tune enable / disable	<b>APte</b>	<b>d ,SA</b> disabled or <b>EnAb</b> enabled	<b>d ,SA</b>	Always
Manual Control select enable / disable	<b>POEn</b>	<b>d ,SA</b> disabled or <b>EnAb</b> enabled	<b>d ,SA</b>	Always
Setpoint Select shown in Operator Mode, enable / disable	<b>SSEn</b>	<b>d ,SA</b> disabled or <b>EnAb</b> enabled	<b>d ,SA</b>	Slot A or B fitted with RSP module
Setpoint ramp shown in operator mode, enable / disable	<b>SPr</b>	<b>d ,SA</b> disabled or <b>EnAb</b> enabled	<b>d ,SA</b>	Always
SP Ramp Rate Value	<b>rP</b>	1 to 9999 units/hour or Off (blank)	<b>Blank</b>	Always



Parameter	Lower Display	Upper Display Adjustment Range	Default Value	When Visible
Setpoint Value	SP	Within scale range upper and lower limits	Range minimum	Always
Local Setpoint Value	LSP _LSP or ≡LSP	Within scale range upper and lower limits. _ or ≡ before the legend indicates if this is the currently active SP	Range minimum.	OPnA or OPnb = rSP ,
Setpoint 1 Value	SP 1 _SP 1 or ≡SP 1	Within scale range upper and lower limits. _ or ≡ before the legend indicates if this is the currently active SP	Range minimum.	d 01 or d 02 = d 15 1
Setpoint2 Value	SP2 _SP2 or ≡SP2	Within scale range upper and lower limits. _ or ≡ before the legend indicates if this is the currently active SP	Range minimum.	d 01 or d 02 = d 15 1
Set-up Lock Code	SLoc	0 to 9999	10	Always

\*\*First Operator mode displays follows.

**Note:**

*Alarm parameters marked \* are repeated in Configuration Mode.*

**Note:**

*\*\*Once the complete list of Set Up Mode parameters has been displayed, the first Operator Mode display is shown without exiting from Set Up Mode. Display seen is dependant on the Display Strategy and status of Auto/Manual mode selection.*

### DC1200 & DC1700 Controllers - Operator Mode

This is the mode used during normal operation of the instrument. It can be accessed from Select Mode, and is the usual mode entered at power-up. The available displays are dependent upon whether Dual or Remote Setpoint modes are being used, whether Setpoint Ramping is enabled and the setting of the Display Strategy parameter in Configuration Mode.

#### **WARNING:**

**IN NORMAL OPERATION, THE OPERATOR MUST NOT REMOVE THE CONTROLLER FROM ITS HOUSING OR HAVE UNRESTRICTED ACCESS TO THE REAR TERMINALS, AS THIS WOULD PROVIDE POTENTIAL CONTACT WITH HAZARDOUS LIVE PARTS.**

#### **CAUTION:**



**Set all Configuration Mode parameters and Set Up Mode parameters as required before starting normal operations.**

### DC1200 & DC1700 Controllers – Extended Operator Mode

Using the PC configuration software, it is possible to extend the Operator Mode displays available by adding parameters from Setup Mode. When an extended Operator Mode is configured the additional parameters are available after the standard operator displays.

### Navigating in Operator Mode

Press  to move between displays.

When a display value can be adjusted, use  or  to change its value.

#### **Note:**

*The operator can freely view the parameters in this mode, but alteration depends on the settings in the Configuration and Set Up Modes. All parameters in Display strategy 6 are read only, and can only be adjusted via Setup mode.*

Table 13. DC1200 & DC1700 Operator Mode Displays

Upper Display	Lower Display	When Visible	Description
PV Value	Active SP Value	Display strategy 1 and 2. <i>(Initial Screen)</i>	Process Variable and target value of currently selected Setpoint. <i>Local SP is adjustable in Strategy 2</i>
PV Value	Actual SP Value	Display strategy 3 and 6 <i>(Initial Screen)</i>	Process Variable and actual value of selected Setpoint (e.g. ramping SP value). <i>Read only</i>
PV Value	<i>Blank</i>	Display strategy 4. <i>(Initial Screen)</i>	Shows Process Variable. <i>Read only</i>
Actual SP Value	<i>Blank</i>	Display strategy 5. <i>(Initial Screen)</i>	Shows target value of currently selected Setpoint. <i>Read only</i>
SP Value	<b>SP</b>	Display strategy 1, 3, 4, 5 and 6 if Digital Input is not <b>d I S I</b> in config mode and RSP is not fitted	Target value of Setpoint. <i>Adjustable except in Strategy 6</i>
SP1 Value	<b>SP 1</b> or <b>_SP 1</b>	If Digital Input is set for dual SP ( <b>d I S I</b> in config mode).	Target value of Setpoint 1. <b>_SP 1</b> means SP1 is selected as the active Setpoint. <i>Adjustable except in Strategy 6</i>
SP2 Value	<b>SP 2</b> or <b>_SP 2</b>	If Digital Input is set for dual SP ( <b>d I S I</b> in config mode).	Target value of Setpoint 2. <b>_SP 2</b> means SP2 is selected as the active Setpoint. <i>Adjustable except in Strategy 6</i>
Local Setpoint Value	<b>LSP</b> <b>_LSP</b> or <b>≡LSP</b>	If Remote Setpoint Input is fitted and Digital Input is not <b>d I S I</b> in config mode	Target value of Local Setpoint. <b>_LSP</b> means the local setpoint is selected as the active SP (if the digital input has been overridden, the <b>≡</b> character is lit instead). <i>Adjustable except in Strategy 6</i>
Remote Setpoint Value	<b>rSP</b> <b>_rSP</b> or <b>≡rSP</b>	If Remote Setpoint Input is fitted and Digital Input is not <b>d I S I</b> in config mode	Target value of Remote Setpoint. <b>_rSP</b> means the remote setpoint is selected as the active SP (if the digital input has been overridden, the <b>≡</b> character is lit instead). <i>Read only</i>
<b>LSP</b> <b>rSP</b> or <b>d I S I</b>	<b>SP S</b>	If Remote Setpoint Input is fitted, Digital Input is not <b>d I S I</b> in config mode and <b>SSEn</b> is enabled in Setup mode	Setpoint Select. Selects between Local or Remote Setpoints. <b>LSP</b> = local SP, <b>rSP</b> = remote SP, <b>d I S I</b> = selection via digital input (if configured). <i>Note: LSP or rSP will override the digital input (active SP indication changes to ≡)</i> <i>Adjustable except in Strategy 6</i>
Actual SP Value	<b>SP rP</b>	If a Ramping Setpoint is in use ( <b>rP</b> not <i>Blank</i> ).	Actual value of selected Setpoint (e.g. ramping SP value). <i>Read only</i>
SP Ramp Rate Value	<b>rP</b>	If <b>SP r</b> (ramping SP) is enabled in Setup mode.	Setpoint ramping rate, in units per hour. Set to <i>Blank</i> (higher than <b>9999</b> ) to turn off ramping. <i>Adjustable except in Strategy 6</i>

Upper Display	Lower Display	When Visible	Description
Active Alarm Status	ALSt	When any alarm is active.  <b>ALM</b> indicator will also flash	Upper display shows which alarm(s) are active. Inactive alarms are blank
			1 Alarm 1 Active
			2 Alarm 2 Active
			L Loop Alarm Active



**Note:**

When an extended Operator Mode is configured the additional parameters are available after the above parameters. Extended Operator Mode parameters can only be configured using the PC software.

### Adjusting the Local Setpoint(s)

Setpoints can be adjusted within the limits set by the Setpoint Upper and Lower Limit parameters in Setup. Operator Mode adjustment of Setpoint is not possible if Display Strategy 6 has been selected on Configuration Mode.



Press  to select the adjustable setpoint display

Press  or  to adjust the setpoint to the required value.

### Adjusting the Setpoint Ramp Rate

The ramp rate may be adjusted in the range 1 to 9999 and OFF. Increasing the ramp rate value beyond 9999 will cause the upper display to go blank and setpoint ramping to be switched OFF. Setpoint ramping can be resumed by decreasing the ramp rate to 9999 or less.

Press  to select the adjustable setpoint display

Press  or  to adjust the setpoint to the required value.

**WARNING:**

**THE SETPOINT RAMP FEATURE DISABLES THE PRE-TUNE FACILITY. THE SELF-TUNE FACILITY WILL COMMENCE ONLY AFTER THE SETPOINT HAS COMPLETED THE RAMP.**



## Manual Control Mode

To allow manual control to be selected in Operator Mode, **PoEn** must be enabled in Set Up Mode. Manual Mode can be selected using the front keys or by use of a digital input if one has been fitted and configured for this function.

### Selecting/deselecting Manual Control Mode

Press the  key to toggle between Automatic and Manual control.

The  indicator flashes continually in Manual Mode

Press  or  to adjust the output power to the required value.

### CAUTION:

**The Manual Mode power level can be adjusted from 0 to 100% (-100 to +100% for dual output). It is not restricted by the Output Power Limit parameter **OPUL**.**

### Note:

*Disabling **PoEn** in Set Up Mode whilst manual control mode is active will lock the controller into manual mode. Pressing the Auto/Man key will no longer cause a return to automatic control. To exit from Manual Mode, **PoEn** must temporarily be re-enabled.*

### DC1200 & DC1700 Controllers –Communications Parameters

The Modbus parameter addresses, and the possible ASCII message types and parameter indents for the DC1200 & DC1700 are detailed below. RO indicates a parameter is read only, R/W indicates it can also be written to. Communications writes will not implemented if the Communications Write Parameter is disabled. Refer to the Modbus and ASCII Communications sections of this manual for details of the protocols used.

#### Bit Parameters

Bit parameters are not applicable to the ASCII protocol.

Table 14. DC1200 & DC1700 Communications - Bit Parameters

Parameter	Modbus Parameter No.		Notes
Communication Write Status	1	RO	1 = Write Enabled, 0 = Write Disabled. A negative acknowledgement (exception code 3) is sent to write commands if communications writes are disabled
Auto / Manual	2	R/W	1 = Manual Control, 0 = Automatic Control
Self Tune	3	R/W	1 = Activate(d), 0 = Dis-engage(d)
Pre tune	4	R/W	1 = Activate(d), 0 = Dis-engage(d)
Alarm 1 Status	5	RO	1 = Active, 0 = Inactive
Alarm 2 Status	6	RO	1 = Active, 0 = Inactive
Setpoint Ramping	7	R/W	1 = Enable(d), 0 = Disable(d)
Loop Alarm Status	10	R/W	1 = Active/Enable, 0 = Inactive/Disable
Loop Alarm	12	R/W	Read to get loop alarm status. Write 0/1 to disable/enable.
Digital Input 2	13	RO	State of Option B digital input.

To set the bit value to 1 write FF, to set the bit value to 0 write 00. Refer to Function Code 05 in the Modbus Communications section.

#### Word Parameters

Table 15. DC1200 & DC1700 Communications - Word Parameters

Parameter	Modbus Parameter No.		ASCII Ident & Message Types		Notes
Process Variable	1	RO	<b>M</b> Type 2	RO	Current value of PV.
					If under-range = 62976 (<??>5 ASCII)
					If over-range = 63232 (<??>0 ASCII)
					If Sensor break = 63488 (ASCII = n/a)
Setpoint	2	R/W	<b>S</b> Type 2 Type 3/4	RO R/W	Value of currently selected setpoint. (Target setpoint if ramping). Parameter is read only if the current setpoint is RSP.
Output Power	3	R/W	<b>W</b> Type 2 Type 3/4	RO R/W	0% to 100% for single output; -100% to +100% for dual output control. Read Only if not in manual control.
Deviation	4	RO	<b>V</b> Type 2	RO	Difference between Process Variable and Setpoint (value = PV-SP)

Parameter	Modbus Parameter No.		ASCII Ident & Message Types		Notes
Secondary Proportional Band	5	R/W	<b>U</b> Type 2, 3/4	R/W	Adjustable 0.0% to 999.9% of input span. Read only when Self-Tuning.
Primary Proportional Band	6	R/W	<b>P</b> Type 2, 3/4	R/W	Adjustable 0.0% to 999.9% of input span. Read only when Self-Tuning.
Direct / Reverse Acting	7	R/W			1 = Direct Acting, 0 = Reverse
Automatic Reset Time (or Loop Alarm Time)	8	R/W	<b>I</b> Type 2, 3/4	R/W	Integral Time Constant value. (or Loop Alarm Time value in ON/OFF control mode if Loop Alarm Enabled) Read only if Self-Tuning. ASCII range: 0 to 99m 59sec (99.59) Modbus range: 0 to 5999
Rate	9	R/W	<b>D</b> Type 2, 3/4	R/W	Derivative Time Constant value. Read only if Self-Tuning. ASCII range: 0 to 99m 59secs. (99.59) Modbus range: 0 to 5999
Output 1 Cycle time	10	R/W	<b>N</b> Type 2 Type 3/4	RO R/W	0.5, 1, 2, 4, 8, 16, 32, 64, 128, 256 or 512 seconds.
Scale Range Lower Limit	11	R/W	<b>H</b> Type 2 Type 3/4	RO R/W	Lower limit of scaled input range
Scale Range Upper Limit	12	R/W	<b>G</b> Type 2 Type 3/4	RO R/W	Upper limit of scaled input range
Alarm 1 Value	13	R/W	<b>C</b> Type 2, 3/4	R/W	Alarm 1 active at this level
Alarm 2 Value	14	R/W	<b>E</b> Type 2, 3/4	R/W	Alarm 2 active at this level
Manual Reset	15	R/W	<b>J</b> Type 2, 3/4	R/W	Bias value. 0% to 100% for single control output or -100% to +100% for dual outputs
Overlap / Deadband	16	R/W	<b>K</b> Type 2, 3/4	R/W	20% to +20% of <b>PB_P + PB_S</b> ; Negative value = Deadband Positive value = Overlap
On / Off Differential	17	R/W	<b>F</b> Type 2, 3/4	R/W	0.1% to 10.0% of input span Used for Primary output on/off differential and for combined Primary and Secondary on/off differential.
Decimal Point Position	18	R/W	<b>Q</b> Type 2 Type 3/4	RO R/W	0 = xxxx 1 = xxx.x 2 = xx.xx 3 = x.xxx Read only if not Linear Input.
Output 2 Cycle Time.	19	R/W	<b>O</b> Type 2 Type 3/4	RO R/W	0.5, 1, 2, 4, 8, 16, 32, 64, 128, 256 or 512 seconds.



Parameter	Modbus Parameter No.		ASCII Ident & Message Types		Notes
Primary Output Power Limit	20	R/W	<b>B</b> Type 2 Type 3/4	RO R/W	Safety power limit; 0 to 100 %.
Actual Setpoint	21	RO			Current (ramping) value of selected setpoint.
Setpoint Upper Limit	22	R/W	<b>A</b> Type 2 Type 3/4	RO R/W	Maximum setpoint value. Current SP to Input Range Maximum
Setpoint Lower Limit	23	R/W	<b>T</b> Type 2 Type 3/4	RO R/W	Minimum setpoint value. Current SP to Input Range Minimum
Setpoint Ramp Rate	24	R/W	<b>^</b> Type 2 Type 3/4	RO R/W	0 = Off, 1 to 9999 increments / hour. Dec Point position as for input range.
Input Filter Time Constant	25	R/W	<b>m</b> Type 2, 3/4	R/W	0 to 100 seconds
Process Value Offset	26	R/W	<b>v</b> Type 2 Type 3/4	RO R/W	Modified PV = Actual PV + PV Offset. Limited by Scale Range Maximum and Scale Range Minimum.
Re-transmit Output Maximum	27	R/W	<b>[</b> Type 2, 3/4	R/W	Maximum scale value for retransmit output, 1999 to 9999. This parameter applies to the first re-transmit output fitted (see also Modbus parameters 2214, 2224 & 2234).
Re-transmit Output Minimum	28	R/W	<b>\</b> Type 2, 3/4	R/W	Minimum scale value for retransmit output, 1999 to 9999. This parameter applies to the first re-transmit output fitted (see also Modbus parameters 2215, 2225 & 2235).
Setpoint 2	29	R/W			Value of Setpoint 2
Remote Setpoint	30	RO			Value of Remote Setpoint. Returns 0FFFFhex if RSP not fitted.
Remote Setpoint Offset	31	R/W	<b>~</b> Type 2, 3/4	R/W	Modified RSP = Actual RSP + RSP Offset. Limited by Scale Range Maximum and Scale Range Minimum.
Alarm 1 Hysteresis	32	R/W			0 to 100% of span
Alarm 2 Hysteresis	33	R/W			0 to 100% of span
Setpoint 1	34	R/W			Value of Setpoint 1
Setpoint Select	35	R/W			Shows which is the currently selected active setpoint. If a digital input has been configured for Setpoint Select, it will take priority over this parameter 1 = SP1 or LSP 2 = SP2 100hex = RSP



Parameter	Modbus Parameter No.		ASCII Ident & Message Types		Notes																		
Controller commands			Z Type 3/4	R/W	<p>Only Type 3 / 4 ASCII messages are allowed with this parameter. The {DATA} field must be one of eight five-digit numbers. The commands corresponding to the {DATA} field value are:</p> <ul style="list-style-type: none"> <li>00010 = Activate Manual Control</li> <li>00020 = Activate Automatic Control</li> <li>00030 = Activate the Self-Tune</li> <li>00040 = De-activate the Self-Tune</li> <li>00050 = Request Pre-Tune</li> <li>00060 = Abort Pre-Tune</li> <li>00130 = Activate Loop Alarm</li> <li>00140 = De-activate Loop Alarm</li> </ul>																		
Controller Status			L Type 2	RO	<table border="1"> <thead> <tr> <th>Bit</th> <th>Meaning</th> </tr> </thead> <tbody> <tr> <td>0</td> <td>Alarm 1 status. 0 = activated, 1 = safe</td> </tr> <tr> <td>1</td> <td>Alarm 2 status. 0 = activated, 1 = safe</td> </tr> <tr> <td>2</td> <td>Self-Tune status. 0 = disabled 1 = activated</td> </tr> <tr> <td>3</td> <td>Change Indicator. 1 = A parameter other than controller status, PV or Output power has been changed since the last time the status word was read.</td> </tr> <tr> <td>4</td> <td>Comms write status: 0 = disabled 1 = enabled.</td> </tr> <tr> <td>5</td> <td>A/M control. 0 = disabled 1 = enabled</td> </tr> <tr> <td>7</td> <td>Pre-tune status. 0 = disabled 1 = enabled.</td> </tr> <tr> <td>8</td> <td>Loop alarm status. 0 = activated, 1 = safe.</td> </tr> </tbody> </table>	Bit	Meaning	0	Alarm 1 status. 0 = activated, 1 = safe	1	Alarm 2 status. 0 = activated, 1 = safe	2	Self-Tune status. 0 = disabled 1 = activated	3	Change Indicator. 1 = A parameter other than controller status, PV or Output power has been changed since the last time the status word was read.	4	Comms write status: 0 = disabled 1 = enabled.	5	A/M control. 0 = disabled 1 = enabled	7	Pre-tune status. 0 = disabled 1 = enabled.	8	Loop alarm status. 0 = activated, 1 = safe.
					Bit	Meaning																	
					0	Alarm 1 status. 0 = activated, 1 = safe																	
					1	Alarm 2 status. 0 = activated, 1 = safe																	
					2	Self-Tune status. 0 = disabled 1 = activated																	
					3	Change Indicator. 1 = A parameter other than controller status, PV or Output power has been changed since the last time the status word was read.																	
					4	Comms write status: 0 = disabled 1 = enabled.																	
					5	A/M control. 0 = disabled 1 = enabled																	
					7	Pre-tune status. 0 = disabled 1 = enabled.																	
8	Loop alarm status. 0 = activated, 1 = safe.																						
Scan Table			] Type 2	RO	<p>Reads back main process values. Response is: L{N}25aaaaabbbbbbccccddddeeeeeA* where:</p> <ul style="list-style-type: none"> <li>aaaaa = Actual Setpoint value</li> <li>bbbbbb = Process Variable value</li> <li>cccc = Primary PID Power value</li> <li>dddd = Secondary PID Power value</li> <li>eeee = Controller Status (see above)</li> </ul>																		
Equipment ID	122	RO			The four digit number 17D4 (hex)																		

Parameter	Modbus		ASCII Ident & Message Types		Notes	
	Parameter No.					
Serial Number Low	123	RO			Digits aaaa	Unit serial number. Format aaaa bbbb cccc, (12 BCD digits).
Serial Number Mid	124	RO			Digits bbbb	
Serial Number High	125	RO			Digits cccc	
Date of manufacture	126	RO			Manufacturing date code as an encoded binary number. (e.g. 0403 for April 2003 is returned as 193hex)	
Product Revision Level	129	RO			Bits 0 – 7: Alpha part of PRL. (e.g. A = 01hex) Bits 8 – 15: Numeric part of PRL. (e.g. 13 = 0Dhex)	
Firmware Version	130	RO			Bits 0 – 4: Revision number (1,2...) Bits 5 – 9: Alpha version (A=0, B=1...) Bits 10 – 15: Numeric version (starting from 121 = 0)	
Input status	133	RO			Input status. Read Only. Bit 0: Sensor break flag Bit 1: Under-range flag Bit 2: Over-range flag	
Remote Setpoint Lower Limit	2123	R/W	Y Type 2, 3/4	R/W	RSP value to be used when RSP input is at minimum. -1999 to 9999	
Remote Setpoint Upper Limit	2124	R/W	X Type 2, 3/4	R/W	RSP value to be used when RSP input is at minimum. -1999 to 9999	
Option Slot 1 Re-transmit output Maximum	2214	R/W			Maximum scale value for retransmit output in slot 1, -1999 to 9999.	
Option Slot 1 Re-transmit output Minimum	2215	R/W			Minimum scale value for retransmit output in slot 1, -1999 to 9999.	
Option Slot 2 Re-transmit output Maximum	2224	R/W			Maximum scale value for retransmit output in slot 2, -1999 to 9999.	
Option Slot 2 Re-transmit output Minimum	2225	R/W			Minimum scale value for retransmit output in slot 2, -1999 to 9999.	
Option Slot 3 Re-transmit output Maximum	2234	R/W			Maximum scale value for retransmit output in slot 3, -1999 to 9999.	
Option Slot 3 Re-transmit output Minimum	2235	R/W			Minimum scale value for retransmit output in slot 3, -1999 to 9999.	

**Note:**

*Some of the parameters that do not apply for a particular configuration will accept reads and writes (e.g. attempting to scale a Linear output which has not been fitted). Read only parameters will return an exception if an attempt is made to write values to them.*

## 9 DC120T & DC170T VMD Controller – Model Group

These controllers are designed to control motorised valves using a three point stepping Valve Motor Drive (VMD) control algorithm. The DC120T 1/16 –DIN VMD Controller (48 x 48mm) and DC170T 1/8 –DIN VMD Controller (96 x 48mm) offer similar functionality in two DIN sizes.

Open loop valve control	Two process alarms
Valve position indication option	Loop alarm
Auto/Manual Tuning	RS485 Modbus communications option
Remote setpoint option	PC configuration option

### Special Wiring Considerations for Valve Motor Control

Valve Motor Drive (VMD) Controllers require two identical outputs to be assigned to position the valve. One to Open and one to Close the valve. These outputs can be two relays, two triacs, two SSR drivers or one dual relay. The relay contacts are rated at 240VAC (120V max for direct Valve Motor control – see **CAUTION** below).

When using two relays (with SPDT change-over contacts), it is recommended to interlock the relay wiring as shown. This prevents both motor windings from being driven at the same time, even under fault conditions.

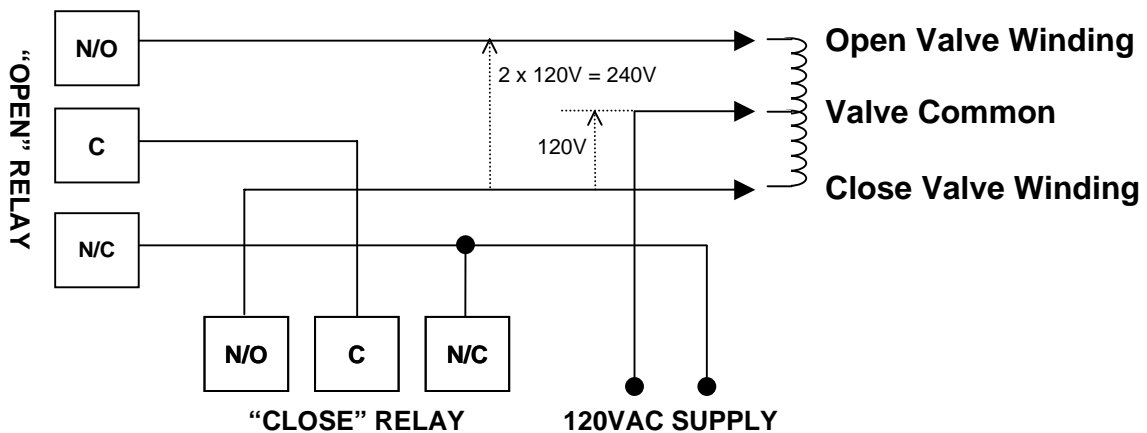

Figure 38. Interlocking of Valve Relays

#### **CAUTION:**

The windings of a valve motor effectively form an Autotransformer. This causes a voltage doubling effect when power is applied to either the Open or Close terminal, causing twice the supplied voltage at the other terminal. For this reason, switching devices directly connected to the valve motor, must only be used up to half of their rated voltage. The maximum motor voltage when using the internal relays/triacs is therefore 120V unless interposing relays are used. Interposing relays or other devices used to control the valve must themselves be rated for twice the motor supply voltage.

### DC120T & DC170T VMD Controllers - Configuration Mode

This mode is normally used only when the instrument is configured for the first time or when a major change is made to the instruments characteristics. The Configuration Mode parameters must be set as required before adjusting parameters in Setup Mode, or attempting to use the instrument in an application.

#### Entry into the Configuration Mode

##### **CAUTION:**

**Adjustments to these parameters should only be performed by personnel competent and authorised to do so.**

Configuration is entered from Select Mode

Hold down  and press  to force the controller into the Select Mode.

then

Press  or  to navigate to the Configuration Mode option, then press .

##### **Note:**

*Entry into this mode is security-protected by the Configuration Mode Lock Code. Refer to the Unlock Code section for more details.*



#### Scrolling through Parameters and Values

Press  to scroll through the parameters (parameters are described below).

##### **Note:**

*Only parameters that are applicable to the hardware options chosen will be displayed.*

#### Changing Parameter Values

Press  to navigate to the required parameter, then press  or  to set the value as required.

Once the value is changed, the display will flash to indicate that confirmation of the change is required. The value will revert back if not confirmed within 10 seconds.

Press  to accept the change.

Or

Press  to reject the change and to move onto the next parameter.

Hold down  and press  to return to Select Mode.

##### **Note:**

*If there is no key activity for 2 minutes the instrument returns to the operator mode.*

Table 16. DC120T & DC170T Configuration Mode Parameters

Parameter	Lower Display	Upper Display	Description	Default Value	When Visible
Input type and Range	<i>InPt</i>	<i>bC</i>	B type: 100 to 1824 °C	<i>JC</i> for Europe	Always
		<i>bF</i>	B type: 211 to 3315 °F		
		<i>cC</i>	C type: 0 to 2320 °C	<i>JF</i> for USA	
		<i>cF</i>	C type: 32 to 4208 °F		
		<i>JC</i>	J type: -200 to 1200 °C		
		<i>JF</i>	J type: -328 to 2192 °F		
		<i>J.C</i>	J type: -128.8 to 537.7 °C with decimal point		
		<i>J.F</i>	J type: -199.9 to 999.9 °F with decimal point		
		<i>KC</i>	K type: -240 to 1373 °C		
		<i>KF</i>	K type: -400 to 2503 °F		
		<i>K.C</i>	K type: -128.8 to 537.7 °C with decimal point		
		<i>K.F</i>	K type: -199.9 to 999.9 °F with decimal point		
		<i>LC</i>	L type: 0 to 762 °C		
		<i>LF</i>	L type: 32 to 1403 °F		
		<i>L.C</i>	L type: 0.0 to 537.7 °C with decimal point		
		<i>L.F</i>	L type: 32.0 to 999.9 °F with decimal point		
		<i>NC</i>	N type: 0 to 1399 °C		
		<i>NF</i>	N type: 32 to 2551 °F		
		<i>rC</i>	R type: 0 to 1759 °C		
		<i>rF</i>	R type: 32 to 3198 °F		
		<i>SC</i>	S type: 0 to 1762 °C		
		<i>SF</i>	S type: 32 to 3204 °F		
		<i>tC</i>	T type: -240 to 400 °C		
		<i>tF</i>	T type: -400 to 752 °F		
		<i>t.C</i>	T type: -128.8 to 400.0 °C with decimal point		
		<i>t.F</i>	T type: -199.9 to 752.0 °F with decimal point		
<i>P24C</i>	PtRh20% vs PtRh40%: 0 to 1850 °C				
<i>P24F</i>	PtRh20% vs PtRh40%: 32 to 3362 °F				

Parameter	Lower Display	Upper Display	Description	Default Value	When Visible	
Input type and Range (Continued)	InPt	PtC	Pt100: -199 to 800 °C	JL for Europe	Always	
		PtF	Pt100: -328 to 1472 °F			
		Pt.C	Pt100: -128.8 to 537.7 °C with decimal point			JF for USA
		Pt.F	Pt100: -199.9 to 999.9 °F with decimal point			
		0_20	0 to 20mA DC			
		4_20	4 to 20mA DC			
		0_50	0 to 50mV DC			
		10_50	10 to 50mV DC			
		0_5	0 to 5V DC			
		1_5	1 to 5V DC			
		0_10	0 to 10V DC			
		2_10	2 to 10V DC			
Scale Range Upper Limit	rUL	Scale Range Lower Limit +100 to Range Max		Linear inputs = 1000 (°C/°F inputs = max range)	Always	
Scale Range Lower Limit	rLL	Range Min. to Scale range Upper Limit - 100		Linear = 0 (°C/°F = min range)	Always	
Decimal point position	dPoS	0	Decimal point position in non-temperature ranges. 0 = XXXX 1 = XXX.X 2 = XX.XX 3 = X.XXX	1	InPt = mV, V or mA	
		1				
		2				
		3				
Control Action	Ctrl	rEu	Reverse Acting	rEu	Always	
		dIr	Direct Acting			
Motor Travel Time	tr	0.05 to 5.00 (0 mins 5 secs to 5 mins 0 secs)		1.00	Always	
Alarm 1Type	ALR1	P_H1	Process High Alarm	P_H1	Always	
		P_Lo	Process Low Alarm			
		dE	Deviation Alarm			
		bAnd	Band Alarm			
		nonE	No alarm			

Parameter	Lower Display	Upper Display	Description	Default Value	When Visible
Process High Alarm 1 value*	<b>PhA 1</b>	Range Min. to Range Max. <i>Parameter repeated in Setup Mode</i>		Range Max.	<b>ALA 1 = P_H 1</b>
Process Low Alarm 1 value*	<b>PLA 1</b>	Range Min. to Range Max. <i>Parameter repeated in Setup Mode</i>		Range Min.	<b>ALA 1 = P_Lo</b>
Deviation Alarm 1 Value*	<b>dAL 1</b>	±span from setpoint <i>Parameter repeated in Setup Mode</i>		<b>S</b>	<b>ALA 1 = dE</b>
Band Alarm 1 value*	<b>bAL 1</b>	1 LSD to full span from setpoint. <i>Parameter repeated in Setup Mode</i>		<b>S</b>	<b>ALA 1 = bAnd</b>
Alarm 1 Hysteresis*	<b>AHY 1</b>	1 LSD to 100% of span (in display units) on “safe” side of alarm point. <i>Parameter repeated in Setup Mode</i>		<b>1</b>	Always
Alarm 2 Type	<b>ALA2</b>	As for alarm 1 type		<b>P_Lo</b>	Always
Process High Alarm 2 value*	<b>PhA2</b>	Range Min. to Range Max. <i>Parameter repeated in Setup Mode</i>		Range Max.	<b>ALA2 = P_H 1</b>
Process Low Alarm 2 value*	<b>PLA2</b>	Range Min. to Range Max. <i>Parameter repeated in Setup Mode</i>		Range Min.	<b>ALA2 = P_Lo</b>
Deviation Alarm 2 Value*	<b>dAL2</b>	±span from setpoint. <i>Parameter repeated in Setup Mode</i>		<b>S</b>	<b>ALA2 = dE</b>
Band Alarm 2 value*	<b>bAL2</b>	1 LSD to full span from setpoint. <i>Parameter repeated in Setup Mode</i>		<b>S</b>	<b>ALA2 = bAnd</b>
Alarm 2 Hysteresis*	<b>AHY2</b>	1 LSD to 100% of span (in display units) on “safe” side of alarm point. <i>Parameter repeated in Setup Mode</i>		<b>1</b>	Always
Loop Alarm Enable	<b>LAE n</b>	<b>dISA</b> (disabled) or <b>EnAb</b> (enabled)		<b>dISA</b>	Always
Alarm Inhibit	<b>inh 1</b>	<b>nonE</b>	No alarms Inhibited	<b>nonE</b>	Always
		<b>ALA 1</b>	Alarm 1 inhibited		
		<b>ALA2</b>	Alarm 2 inhibited		
		<b>both</b>	Alarm 1 and alarm 2 inhibited		

Parameter	Lower Display	Upper Display	Description	Default Value	When Visible		
Output 1 Usage**	USE 1	OPN	Valve Motor Open	OPN	OPN 1 is not LIN or none		
		CLS	Valve Motor Close				
		A1_d	Alarm 1, Direct Acting				
		A1_r	Alarm 1, Reverse Acting				
		A2_d	Alarm 2, Direct Acting				
		A2_r	Alarm 2, Reverse Acting				
		LP_d	Loop Alarm, Direct Acting				
		LP_r	Loop Alarm, Reverse Acting				
		Or_d	Logical Alarm 1 OR Alarm 2 Direct Acting				
		Or_r	Logical Alarm 1 OR Alarm 2 Reverse Acting				
		Ar_d	Logical Alarm 1 AND Alarm 2, Direct Acting				
		Ar_r	Logical Alarm 1 AND Alarm 2, Reverse Acting				
		rEtS	Retransmit SP Output			rEtP	OPN 1 = LIN
		rEtP	Retransmit PV Output				
Linear Output 1 Range	tYP 1	0_5	0 to 5 V DC output 1	0_10	OPN 1 = LIN		
		0_10	0 to 10 V DC output				
		2_10	2 to 10 V DC output				
		0_20	0 to 20 mA DC output				
		4_20	4 to 20 mA DC output				
Retransmit Output 1 Scale maximum	ro IH	- 1999 to 9999 Display value at which output will be maximum	Range max	USE 1 = rEtS or rEtP			
Retransmit Output 1 Scale minimum	ro IL	- 1999 to 9999 Display value at which output will be minimum	Range min	USE 1 = rEtS or rEtP			
Output 2 Usage**	USE 2	As for output 1	CLS (rEtP if linear)	OPN 2 is not none			
Linear Output 2 Range	tYP 2	As for output 1	0_10	OPN 2 = LIN			



Parameter	Lower Display	Upper Display	Description	Default Value	When Visible
Retransmit Output 2 Scale maximum	<b>ro2H</b>	- 1999 to 9999 Display value at which output will be maximum		Range max	USE2 = rEt5 or rEtP
Retransmit Output 2 Scale minimum	<b>ro2L</b>	- 1999 to 9999 Display value at which output will be minimum		Range min	USE2 = rEt5 or rEtP
Output 3 Usage**	<b>USE3</b>	As for output 1		<b>Al_d</b> (rEtP if linear)	OPn3 is not none
Linear Output 3 Range	<b>tYP3</b>	As for output 1		<b>0_10</b>	OPn3 = Lin
Retransmit Output 3 Scale maximum	<b>ro3H</b>	- 1999 to 9999 Display value at which output will be maximum		Range max	USE3 = rEt5 or rEtP
Retransmit Output 3 Scale minimum	<b>ro3L</b>	- 1999 to 9999 Display value at which output will be minimum		Range min	USE3 = rEt5 or rEtP
Output 4 Usage**	<b>USE4</b>	<b>OPn</b>	Valve Motor Open	<b>Al_d</b>	OPn2 = dr 14
		<b>CLS</b>	Valve Motor Close		
		<b>Al_d</b>	Alarm 1, Direct Acting		
		<b>Al_r</b>	Alarm 1, Reverse Acting		
		<b>A2_d</b>	Alarm 2, Direct Acting		
		<b>A2_r</b>	Alarm 2, Reverse Acting		
		<b>LP_d</b>	Loop Alarm, Direct Acting		
		<b>LP_r</b>	Loop Alarm, Reverse Acting		
		<b>Or_d</b>	Logical Alarm 1 OR Alarm 2 Direct Acting		
		<b>Or_r</b>	Logical Alarm 1 OR Alarm 2 Reverse Acting		
		<b>Ar_d</b>	Logical Alarm 1 AND Alarm 2, Direct Acting		
<b>Ar_r</b>	Logical Alarm 1 AND Alarm 2, Reverse Acting				
Output 5 Usage**	<b>USES</b>	As for output 4		<b>Al_d</b>	OPn3 = dr 14
Display Strategy	<b>dISP</b>	1, 2, 3, 4, 5, 6 or 7 (see Operator Mode)		<b>1</b>	Always

Parameter	Lower Display	Upper Display	Description	Default Value	When Visible
Comms Protocol	Prot	r7bn	Modbus with no parity	r7bn	OPnA = r485
		r7bE	Modbus with Even Parity		
		r7bo	Modbus with Odd Parity		
Bit rate	bAud	1.2	1.2 kbps	4.8	OPnA = r485
		2.4	2.4 kbps		
		4.8	4.8 kbps		
		9.6	9.6 kbps		
		19.2	19.2 kbps		
Communications Address	Addr	Unique address assigned to the instrument in the range of 1 to 255		1	OPnA = r485
Communications Write Enable	CoEn	r_o	Read only. Comms writes ignored	r_w	Always
		r_w	Read / Write. Writing via Comms is possible		
Option Slot A Auxiliary Input Usage	A iPA	rSP	Remote Setpoint Input ( <i>Basic only</i> )	P_in	OPnA = rSP ,
		P_in	Valve Position Indication ( <i>Basic only</i> )		
Option Slot B Auxiliary Input Usage	A iPB	rSP	Remote Setpoint Input ( <i>Full</i> )	P_in	OPnB = rSP ,
		P_in	Valve Position Indication ( <i>Full</i> )		
Digital Input 1 Usage	d iG1	d iS1	Setpoint 1 / Setpoint 2 Select***	d iS1	OPnA = d iG1
		d iAS	Automatic / Manual Select***		
Digital Input 2 Usage	d iG2	d iS1	Setpoint 1 / Setpoint 2 Select***	d iR5	OPnb = rSP ,
		d iAS	Automatic / Manual Select***		
		d iR5	Remote / Local Setpoint Select***		

Parameter	Lower Display	Upper Display	Description	Default Value	When Visible
Remote Auxiliary Input Range	r <sub>inP</sub>	0_20	0 to 20mA DC input	0_10 (or Pot if A <sub>iPB</sub> = P <sub>in</sub> )	OP <sub>nA</sub> or OP <sub>nB</sub> = r <sub>SP</sub>
		4_20	4 to 20mA DC input		
		0_10	0 to 10V DC input		
		2_10	2 to 10V DC input		
		0_5	0 to 5V DC input		
		1_5	1 to 5V DC input		
		100	0 to 100mV DC input		
		Pot	Potentiometer (≥2KΩ)		OP <sub>nB</sub> = r <sub>SP</sub>
Remote Setpoint Upper Limit	r <sub>SPU</sub>	- 1999 to 9999	RSP value to be used when RSP input is at maximum.	Range max	A <sub>iPA</sub> or A <sub>iPB</sub> = r <sub>SP</sub>
Remote Setpoint Lower Limit	r <sub>SPL</sub>	- 1999 to 9999	RSP value to be used when RSP input is at minimum.	Range min	A <sub>iPA</sub> or A <sub>iPB</sub> = r <sub>SP</sub>
Remote Setpoint Offset	r <sub>SPO</sub>	Offset applied to RSP value. Constrained within Scale Range Upper Limit and Scale Range Lower Limit.		0	A <sub>iPA</sub> or A <sub>iPB</sub> = r <sub>SP</sub>
Configuration Mode Lock Code	CLoc	0 to 9999		20	Always

**\*Note:**

Alarm parameters marked \* are repeated in Setup Mode.

**\*\*Note:**

This controller uses Three-Point Stepping control. This requires two identical outputs (2 Relays, 2 Triacs, 2 SSR Drivers or 1 Dual Relay) to be configured for the OP<sub>n</sub> (Valve Open) & CL<sub>S</sub> (Valve Close) functions.

**\*\*\*Note:**

If d<sub>IG1</sub> or d<sub>IG2</sub> = d<sub>IS1</sub> the remote setpoint input feature is disabled. The instrument uses the two internal setpoints (SP1 & SP2) instead.

If d<sub>IG1</sub> and d<sub>IG2</sub> are set to the same value, the status of digital input 2 will take precedence over digital input 1.

d<sub>IG1</sub> cannot be set for Remote/Local Setpoint Selection if (d<sub>IS5</sub>) if Auxiliary Input B is used for Valve Position Indication.

### DC120T & DC170T – Setup Mode

This mode is normally selected only after Configuration Mode has been completed, and is used when a change to the process set up is required. It can affect the range of adjustments available in Operator Mode. Some Setup Mode parameters can be copied into Operator Mode by the PC Configurator software. This is called Extended Operator Mode. These parameters appear after the normal Operator Mode screen sequence has been completed.

**Note:**

*Entry into Setup Mode is security-protected by the Setup Mode lock code.*

#### Entry into the Setup Mode



Hold down  and press  to enter the Select Mode

Press  or  to navigate to the Setup Mode option, then press  to enter Setup Mode.

#### Scrolling through Parameters & Values

Press  to scroll through the parameters (refer to the table below) and their values.

#### Changing Parameter Values

Press  to select the required parameter, then press  or  to set the value as required.

Once the displayed value is changed, the effect is immediate. No confirmation of the change is required.

**Note:**

*If there is no key activity for two minutes the instrument returns to the operator mode.*

#### Adjusting the Valve Parameters

Before Valve Position Indication can be used, the user must first adjust the Set Valve Opened Position and Set Valve Closed Position parameters. These define the input value that will be measured by the Auxiliary Input when the valve is at its *physical* end stops. They must be set correctly even if the valve will not be driven to its end stops in the application. The user may optionally set the Valve Open Limit and Valve Close Limit. These are upper and lower valve position clamps, which the controller will not attempt to drive the valve past.

**Note:**

*Valve Position Indication is only possible if an Auxiliary Input option module is fitted, and has been configured for this function.*

## Set Valve Opened Position & Set Valve Closed Position

Hold down  and press  to enter the Select Mode

Press  or  to navigate to the Setup Mode option, then press  to enter Setup Mode.

Press  to scroll through the parameters until **PcUL** is shown in the Lower Display to indicate that the Set Valve Open Position sequence has started. The Upper Display will be *Blank*.

Press  The Upper Display will now show **oPnG**.

Press  to activate the Open Valve Output until the valve reaches its “fully open” end stop.

Press  The Upper Display will be again be *Blank* and the Auxiliary Input value will be measured and stored in memory as the value equal to the fully open valve position.

Press  to scroll through the parameters until **PcLL** is shown in the Lower Display to indicate that the Set Valve Closed Position sequence has started. The Upper Display will be *Blank*.

Press  The Upper Display will now show **cLSc**.

Press  to activate the Close Valve Output until the valve reaches its “fully closed” end stop.

Press  The Upper Display will be again be *Blank* and the Auxiliary Input value will be measured and stored in memory as the value equal to the fully closed valve position.

### Note:

*If the above sequence is not followed exactly, the valve position will not be accurately reported, and the Valve Open Limit & Valve Close Limit parameters will not work as expected.*

## Valve Position Clamping

Once the physical limits of the valve have been set using the Set Valve Open Position and Set Valve Closed Position parameters, the user may set the upper and lower valve position clamps, which the controller will not attempt to drive the valve past. See parameters **P uL** (Open Limit) to set and **P iLL** (Valve Close Limit) in the following table.

Table 17. DC120T & DC170T Set Up Mode Parameters

Parameter	Lower Display	Upper Display Adjustment Range	Default Value	When Visible
Input Filter Time constant	<b>FILT</b>	OFF, 0.5 to 100.0 secs in 0.5 sec increments	<b>2.0</b>	Always
Process Variable Offset	<b>OFFS</b>	±Span of controller	<b>0</b>	Always
Primary Output Proportional Band	<b>Pb_P</b>	0.5% to 999.9% of input span.	<b>10.0</b>	Always
Automatic Reset (Integral Time Constant)	<b>ArSt</b>	0.01 to 99.59 (1 sec to 99 mins 59 secs) and OFF	<b>5.00</b>	Always
Rate (Derivative Time Constant)	<b>rATE</b>	0.00 to 99.59 (OFF to 99 mins 59 secs)	<b>0.00</b>	Always
Setpoint Upper Limit	<b>SPUL</b>	Current Setpoint value to Scale Range Maximum	Range Max.	Always
Setpoint Lower limit	<b>SPLL</b>	Scale Range Minimum to current Setpoint value	Range Min	Always
Minimum Motor On Time	<b>ton</b>	0.0 to (Motor Travel Time/10) secs in 0.1 sec increments	<b>1.00</b>	Always
Set Valve Opened Position	<b>PcuL</b>	Aux. Input value when valve is fully opened. <i>Note: See above for PcuL setting instructions</i>	Auxiliary Input Range Maximum	<b>A,PA or A,PB = P<sub>in</sub></b>
Set Valve Closed Position	<b>PcLL</b>	Aux. Input value when valve is fully closed. <i>Note: See above for PcLL setting instructions</i>	Auxiliary Input Range Minimum	<b>A,PA or A,PB = P<sub>in</sub></b>
Valve Open Limit	<b>P<sub>uL</sub></b>	Value position max. clamp <b>P<sub>LL</sub> +1 to 100.</b>	<b>100</b>	<b>A,PA or A,PB = P<sub>in</sub></b>
Valve Close Limit	<b>P<sub>LL</sub></b>	Value position min. clamp <b>0 to P<sub>uL</sub> -1</b>	<b>0</b>	<b>A,PA or A,PB = P<sub>in</sub></b>
Process High Alarm 1 value*	<b>PHA1</b>	Range Min. to Range Max.	Range Max.	<b>ALA1 = P<sub>H</sub></b>
Process Low Alarm 1 value*	<b>PLA1</b>	Range Min. to Range Max.	Range Min.	<b>ALA1 = P<sub>Lo</sub></b>
Deviation Alarm 1 Value*	<b>dAL1</b>	±span from setpoint	<b>5</b>	<b>ALA1 = dE</b>
Band Alarm 1 value*	<b>bAL1</b>	1 LSD to full span from setpoint.	<b>5</b>	<b>ALA1 = bAnd</b>
Alarm 1 Hysteresis*	<b>AHY1</b>	Up to 100% of span	<b>1</b>	Always
Process High Alarm 2 value*	<b>PHA2</b>	Range Min. to Range Max.	Range Max.	<b>ALA2 = P<sub>H</sub></b>
Process Low Alarm 2 value*	<b>PLA2</b>	Range Min. to Range Max.	Range Min.	<b>ALA2 = P<sub>Lo</sub></b>

Parameter	Lower Display	Upper Display Adjustment Range	Default Value	When Visible
Deviation Alarm 2 Value	<b>dAL2</b>	±span from setpoint	<b>5</b>	<b>AL2 = dE</b>
Band Alarm 2 value*	<b>bAL2</b>	1 LSD to full span from setpoint.	<b>5</b>	<b>AL2 = bAnd</b>
Alarm 2 Hysteresis*	<b>AH2</b>	Up to 100% of span	<b>1</b>	Always
Auto Pre-tune enable / disable	<b>APt</b>	<b>d, SA</b> disabled or <b>EnAb</b> enabled	<b>d, SA</b>	Always
Manual Control select enable / disable	<b>POEn</b>	<b>d, SA</b> disabled or <b>EnAb</b> enabled	<b>d, SA</b>	Always
Setpoint Select shown in Operator Mode, enable / disable	<b>SSEn</b>	<b>d, SA</b> disabled or <b>EnAb</b> enabled	<b>d, SA</b>	Slot A or B configured for Remote Setpoint
Setpoint ramp shown in operator mode, enable / disable	<b>SPr</b>	<b>d, SA</b> disabled or <b>EnAb</b> enabled	<b>d, SA</b>	Always
SP Ramp Rate Value	<b>rP</b>	1 to 9999 units/hour or Off (blank)	<b>Blank</b>	Always
Setpoint Value	<b>SP</b>	Within scale range upper and lower limits	Range minimum	Always
Local Setpoint Value	<b>LSP</b> <b>_LSP</b> or <b>≡LSP</b>	Within scale range upper and lower limits. - or ≡ before the legend indicates if this is the currently active SP	Range minimum.	<b>OPnA</b> or <b>OPnb = rSP</b> ,
Setpoint 1 Value	<b>SP1</b> <b>_SP1</b> or <b>≡SP1</b>	Within scale range upper and lower limits. - or ≡ before the legend indicates if this is the currently active SP	Range minimum.	<b>d, G1</b> or <b>d, G2 = d, S1</b>
Setpoint2 Value	<b>SP2</b> <b>_SP2</b> or <b>≡SP2</b>	Within scale range upper and lower limits. - or ≡ before the legend indicates if this is the currently active SP	Range minimum.	<b>d, G1</b> or <b>d, G2 = d, S1</b>
Set-up Lock Code	<b>SLoc</b>	0 to 9999	<b>10</b>	Always

\*\*First Operator mode displays follows.

**Note:**

*Alarm parameters marked \* are repeated in Configuration Mode.*

**Note:**

*\*\*Once the complete list of Set Up Mode parameters has been displayed, the first Operator Mode display is shown without exiting from Set Up Mode. Display seen is dependant on the Display Strategy and status of Auto/Manual mode selection.*



### DC120T & DC170T Controllers - Operator Mode

This is the mode used during normal operation of the instrument. It can be accessed from Select Mode, and is the usual mode entered at power-up. The available displays are dependent upon whether Dual or Remote Setpoint modes are being used, whether Setpoint Ramping is enabled and the setting of the Display Strategy parameter in Configuration Mode.

#### WARNING:

**IN NORMAL OPERATION, THE OPERATOR MUST NOT REMOVE THE CONTROLLER FROM ITS HOUSING OR HAVE UNRESTRICTED ACCESS TO THE REAR TERMINALS, AS THIS WOULD PROVIDE POTENTIAL CONTACT WITH HAZARDOUS LIVE PARTS.**

#### CAUTION:



**Set all Configuration Mode parameters and Set Up Mode parameters as required before starting normal operations.**

### DC120T & DC170T Controllers – Extended Operator Mode

Using the PC configuration software, it is possible to extend the available Operator Mode displays by adding parameters from Setup Mode. When an extended Operator Mode is configured the additional parameters are available after the standard operator displays.

#### Navigating in Operator Mode

Press  to move between displays.

When a display value can be adjusted, use  or  to change its value.

#### Note:

*The operator can freely view the parameters in this mode, but alteration depends on the settings in the Configuration and Set Up Modes. All parameters in Display strategy 6 are read only, and can only be adjusted via Setup mode.*

Table 18. DC120T & DC170T Operator Mode Displays

Upper Display	Lower Display	When Visible	Description
PV Value	Active SP Value	Display strategy 1, 2 and 7. <i>(Initial Screen)</i>	Process Variable and target value of currently selected Setpoint. <i>Local SP is adjustable in Strategy 2 &amp; 7</i>
PV Value	Actual SP Value	Display strategy 3 and 6 <i>(Initial Screen)</i>	Process Variable and actual value of selected Setpoint (e.g. ramping SP value). <i>Read only</i>
PV Value	<i>Blank</i>	Display strategy 4. <i>(Initial Screen)</i>	Shows Process Variable. <i>Read only</i>
Actual SP Value	<i>Blank</i>	Display strategy 5. <i>(Initial Screen)</i>	Shows target value of currently selected Setpoint. <i>Read only</i>



Upper Display	Lower Display	When Visible	Description
SP Value	SP	Display strategy 1, 3, 4, 5 and 6 if Digital Input is not <b>d i s i</b> in config mode and RSP is not used.	Target value of Setpoint. <i>Adjustable except in Strategy 6</i>
SP1 Value	SP 1 or -SP 1	Display strategies 1 to 6, if Digital Input is set for dual SP ( <b>d i s i</b> in config mode).	Target value of Setpoint 1. <b>-SP 1</b> means SP1 is selected as the active Setpoint. <i>Adjustable except in Strategy 6</i>
SP2 Value	SP 2 or -SP 2	Display strategies 1 to 6, if Digital Input is set for dual SP ( <b>d i s i</b> in config mode).	Target value of Setpoint 2. <b>-SP 2</b> means SP2 is selected as the active Setpoint. <i>Adjustable except in Strategy 6</i>
Local Setpoint Value	LSP -LSP or ≡LSP	If Remote Setpoint Input is fitted and Digital Input is not <b>d i s i</b> in config mode	Target value of Local Setpoint. <b>-LSP</b> means the local setpoint is selected as the active SP (if the digital input has been overridden, the <b>≡</b> character is lit instead). <i>Adjustable except in Strategy 6</i>
Remote Setpoint Value	rSP -rSP or ≡rSP	If Remote Setpoint Input is fitted and Digital Input is not <b>d i s i</b> in config mode	Target value of Remote Setpoint. <b>-rSP</b> means the remote setpoint is selected as the active SP (if the digital input has been overridden, the <b>≡</b> character is lit instead). <i>Read only</i>
Valve Position Value	P <sub>xxx</sub>	Display strategy 7 if position indication enabled ( <b>A i P A</b> or <b>A i P B = P in</b> )	The valve position as read by the Auxiliary Input. Position is expressed as a percentage from <b>P 0</b> (fully closed) to <b>P 100</b> (fully opened).
LSP rSP or d i s i	SP S	If Remote Setpoint Input is fitted, Digital Input is not <b>d i s i</b> in config mode and <b>SSEn</b> is enabled in Setup mode	Setpoint Select. Selects between Local or Remote Setpoints. <b>LSP</b> = local SP, <b>rSP</b> = remote SP, <b>d i s i</b> = selection via digital input (if configured). <i>Note: LSP or rSP will override the digital input (active SP indication changes to ≡)</i> <i>Adjustable except in Strategy 6</i>
Actual SP Value	SP rP	If a Ramping Setpoint is in use ( <b>rP</b> not <i>Blank</i> ).	Actual value of selected Setpoint (e.g. ramping SP value). <i>Read only</i>
SP Ramp Rate Value	rP	If <b>SP r</b> (ramping SP) is enabled in Setup mode.	Setpoint ramping rate, in units per hour. Set to <i>Blank</i> (higher than <b>9999</b> ) to turn off ramping. <i>Adjustable except in Strategy 6</i>

Upper Display	Lower Display	When Visible	Description
Active Alarm Status	<b>ALSt</b>	When any alarm is active.  <b>ALM</b> indicator will also flash	Upper display shows which alarm(s) are active. Inactive alarms are blank
			<b>1</b> Alarm 1 Active
			<b>2</b> Alarm 2 Active
			<b>L</b> Loop Alarm Active



**Note:**

When an extended Operator Mode is configured, the additional parameters are available after the above parameters. Extended Operator Mode parameters can only be configured using the PC software.

### Adjusting the Local Setpoint(s)

Local Setpoints can be adjusted within the limits set by the Setpoint Upper and Lower Limit parameters in Setup. Operator Mode adjustment of Setpoints is not possible if Display Strategy 6 has been selected on Configuration Mode.



Press  to select the adjustable setpoint display

Press  or  to adjust the setpoint to the required value.

### Adjusting the Setpoint Ramp Rate

The ramp rate may be adjusted in the range 1 to 9999 and OFF. Increasing the ramp rate value beyond 9999 will cause the upper display to go blank and setpoint ramping to be switched OFF. Setpoint ramping can be resumed by decreasing the ramp rate to 9999 or less.

Press  to select the adjustable setpoint display

Press  or  to adjust the setpoint to the required value.

**WARNING:**

**THE SETPOINT RAMP FEATURE DISABLES THE PRE-TUNE FACILITY. THE SELF-TUNE FACILITY WILL COMMENCE ONLY AFTER THE SETPOINT HAS COMPLETED THE RAMP.**

## Manual Control Mode



To allow manual control to be selected in Operator Mode, **PoEn** must be enabled in Set Up Mode. Manual Mode can be selected using the front keys, via serial communications or by use of a digital input if one has been fitted and configured for this function.

When in Manual Mode, the MAN indicator flashes and the lower display shows **MAN**. If Valve Position Indication is enabled the lower display will show **Pxxx** instead of **MAN** (where xxx is the % valve position as read by the Auxiliary Input). **P0** means the valve is fully closed, **P 100** means the valve is fully opened.

### Selecting/deselecting Manual Control Mode

Press the  key to toggle between Automatic and Manual control.

The  indicator flashes continually in Manual Mode

Press  to move the valve motor in the “open” direction or  to move the valve motor in the “close” direction. Keep pressing the key until the desired valve position is achieved.

#### Note:

*Disabling **PoEn** in Set Up Mode whilst manual control mode is active will lock the controller into manual mode. Pressing the Auto/Man key will no longer cause a return to automatic control. To exit from Manual Mode, **PoEn** must temporarily be re-enabled.*

### DC120T & DC170T Controllers – Serial Communications Parameters

The DC120T & DC170T communications parameters are detailed in the following tables. RO indicates a parameter is read only, R/W indicates it can also be written to. Writes will not be implemented if the Communications Write parameter is disabled.

**Note:**

*These models support the Modbus protocol. Refer to the Modbus Communications section for information on message types. The older ASCII protocol is not supported..*

#### Bit Parameters

To set the bit value to 1, write FF. To set the bit value to 0, write 00. Refer to Function Code 05 in the Modbus Communications section for bit writes.

Table 19. DC120T & DC170T Communications - Bit Parameters

Parameter	Modbus Parameter No.		Notes
Communication Write Status	1	RO	1 = Write Enabled, 0 = Write Disabled. A negative acknowledgement (exception code 3) is sent to write commands if communications writes are disabled
Auto / Manual	2	R/W	1 = Manual Control, 0 = Automatic Control
Self Tune	3	R/W	1 = Activate(d), 0 = Dis-engage(d)
Pre tune	4	R/W	1 = Activate(d), 0 = Dis-engage(d)
Alarm 1 Status	5	RO	1 = Active, 0 = Inactive
Alarm 2 Status	6	RO	1 = Active, 0 = Inactive
Setpoint Ramping	7	R/W	1 = Enable(d), 0 = Disable(d)
Loop Alarm Status	10	R/W	1 = Active/Enable, 0 = Inactive/Disable
Loop Alarm	12	R/W	Read for loop alarm status. Write 0/1 to Disable/enable.
Digital Input 2	13	RO	State of Option B digital input.
Auto Pre-tune	15	R/W	1 = Enable(d), 0 = Disable(d)

#### Word Parameters

Table 20. DC120T & DC170T Communications - Word Parameters

Parameter	Modbus Parameter No.		Notes
Process Variable	1	RO	Current value of PV. Under-range = 62976, over-range = 63232, Sensor break = 63488
Setpoint	2	R/W	Value of currently selected setpoint. (Target setpoint if ramping). Read only if the current setpoint is RSP.
Deviation	4	RO	Difference between Process Variable and Setpoint (value = PV-SP)
Primary Proportional Band	6	R/W	Adjustable 0.5% to 999.9% of input span. Read only when Self-Tuning.
Control Action	7	R/W	1 = Direct Acting, 0 = Reverse
Automatic Reset Time	8	R/W	Integral Time Constant value. Adjustable 0 to 5999. Read only if Self-Tuning.

Parameter	Modbus Parameter No.		Notes
Rate	9	R/W	Derivative Time Constant value. Read only if Self-Tuning. Adjustable 0 to 5999
Motor Travel Time	10	R/W	Adjustable 5 to 300 seconds
Scale Range Lower Limit	11	R/W	Lower limit of scaled input range
Scale Range Upper Limit		R/W	Upper limit of scaled input range
Alarm 1 Value	13		Alarm 1 active at this level
Alarm 2 Value	14	R/W	Alarm 2 active at this level
Decimal Point Position	18	R/W	0 = xxxx 1 = xxx.x 2 = xx.xx 3 = x.xxx Read only if not Linear Input.
Minimum Motor On Time	19	R/W	Adjustable 0 to (Motor Travel Time/10) in 0.1 sec increments
Actual Setpoint	21	RO	Current (ramping) value of selected setpoint.
Setpoint Upper Limit	22	R/W	Maximum setpoint value. Current SP to Input Range Maximum
Setpoint Lower Limit	23	R/W	Minimum setpoint value. Current SP to Input Range Minimum
Setpoint Ramp Rate	24	R/W	0 = Off, 1 to 9999 increments / hour. Dec Point position as for input range.
Input Filter Time Constant		R/W	0 to 100 seconds
Process Value Offset	26		Modified PV = Actual PV + PV Offset. Limited by Scale Range Maximum and Scale Range Minimum.
Re-transmit Output Maximum	27	R/W	Maximum scale value for retransmit output, 1999 to 9999. This parameter applies to the first re-transmit output fitted (see also parameters 2214, 2224 & 2234).
Re-transmit Output Minimum		R/W	Minimum scale value for retransmit output, 1999 to 9999. This parameter applies to the first re-transmit output fitted (see also parameters 2215, 2225 & 2235).
Setpoint 2		R/W	Value of Setpoint 2
Remote Setpoint	30	RO	Value of Remote Setpoint. Returns 0FFFFhex if RSP not fitted.
Remote Setpoint Offset	31	R/W	Modified RSP = Actual RSP + RSP Offset. Limited by Scale Range Maximum and Scale Range Minimum.
Alarm 1 Hysteresis	32	R/W	0 to 100% of span
Alarm 2 Hysteresis	33	R/W	0 to 100% of span
Setpoint 1	34	R/W	Value of Setpoint 1
Setpoint Select	35	R/W	Shows which is the currently selected active setpoint. If a digital input has been configured for Setpoint Select, it will take priority over this parameter 1 = SP1 or LSP, 2 = SP2, 100hex = RSP
Equipment ID	122	RO	The four digit model number 181A

Parameter	Modbus Parameter No.		Notes
Serial Number Low	123	RO	Digits aaaa
Serial Number Mid	124		Digits bbbb
Serial Number High	125		Digits cccc
Date of manufacture	126		Manufacturing date code as an encoded binary number. E.g. 0403 for April 2003 is returned as 193hex
Product Revision Level	129	RO	Bits 0 – 7: Alpha part of PRL. (e.g. A = 01hex) Bits 8 – 15: Numeric part of PRL. (e.g. 13 = 0Dhex)
Firmware Version	130	RO	Bits 0 – 4: Revision number (1,2...) Bits 5 – 9: Alpha version (A=0, B=1...) Bits 10 – 15: Numeric version (starting from 121 = 0)
Input status	133	RO	Input status. Read Only. Bit 0: Sensor break flag Bit 1: Under-range flag Bit 2: Over-range flag
Remote Setpoint Lower Limit	2123	R/W	RSP value to be used when RSP input is at minimum. -1999 to 9999
Remote Setpoint Upper Limit	2124	R/W	RSP value to be used when RSP input is at minimum. -1999 to 9999
Option Slot 1 Re-transmit output Maximum	2214	R/W	Maximum scale value for retransmit output in slot 1, -1999 to 9999.
Option Slot 1 Re-transmit output Minimum	2215	R/W	Minimum scale value for retransmit output in slot 1, -1999 to 9999.
Option Slot 2 Re-transmit output Maximum		R/W	Maximum scale value for retransmit output in slot 2, -1999 to 9999.
Option Slot 2 Re-transmit output Minimum	2225	R/W	Minimum scale value for retransmit output in slot 2, -1999 to 9999.
Option Slot 3 Re-transmit output Maximum	2234	R/W	Maximum scale value for retransmit output in slot 3, -1999 to 9999.
Option Slot 3 Re-transmit output Minimum	2235	R/W	Minimum scale value for retransmit output in slot 3, -1999 to 9999.
Valve Position Indication	3106	RO	The position of the valve as read by the Auxiliary Input if configured for this function. 0 to 100 expressed as the percentage the valve is open.

**Note:**

*Some of the parameters that do not apply for a particular configuration will accept reads and writes (e.g. attempting to scale a Linear output which has not been fitted). Read only parameters will return an exception if an attempt is made to write values to them.*

## 10 Model DC120L Limit Controller

Limit Controllers protect processes that could be damaged or become hazardous under fault conditions. They shut down the process at a preset level. The DC120L is available in 1/16 DIN (48 x 48mm) size only.

High or low trip	5 amp latching limit relay
Exceed & relay trip indicators	2 Annunciators or process alarms
RS485 Modbus and ASCII comms option	Remote reset option
PV retransmit option	PC configuration option

### DC120L Limit Controller - Configuration Mode

This mode is normally used only when the instrument is configured for the first time or when a major change is made to the controller characteristics. The Configuration Mode parameters must be set as required before adjusting parameters in Setup Mode, or attempting to use the instrument in an application.

#### Entry into the Configuration Mode



##### **CAUTION:**

**Adjustments to these parameters should only be performed by personnel competent and authorised to do so.**

Configuration is entered from Select Mode

Hold down  and press  to force the controller into the Select Mode.

then

Press  or  to navigate to the Configuration Mode option, then press .

##### **Note:**

*Entry into this mode is security-protected by the Configuration Mode Lock Code. Refer to the Unlock Code section for more details.*

#### Scrolling through Parameters and Values

Press  to scroll through the parameters (parameters are described below).

##### **Note:**

*Only parameters that are applicable to the hardware options chosen will be displayed.*



### Changing Parameter Values

Press **SETUP** to navigate to the required parameter, then press **▲** or **▼** to set the value as required.

When a value is changed, the display will flash to indicate that confirmation of the change is required. The value will revert back if not confirmed within 10 seconds.

Press **RESET** to accept the change.

Or

Press **SETUP** to reject the change and to move onto the next parameter.

Hold down **SETUP** and press **▲** to return to Select Mode.

#### Note:

*If there is no key activity for 2 minutes, the instrument returns to the operator mode.*

Table 21. Model DC120L Configuration Mode Parameters

Parameter	Lower Display	Upper Display	Description	Default Value	When Visible
Input type and Range	InPt	bC	B type: 100 to 1824 °C	J <b>C</b> for Europe	Always
		bF	B type: 211 to 3315 °F		
		C	C type: 0 to 2320 °C	J <b>F</b> for USA	
		C	C type: 32 to 4208 °F		
		J	J type: -200 to 1200 °C		
		J	J type: -328 to 2192 °F		
		J.C	J type: -128.8 to 537.7 °C with decimal point		
		J.F	J type: -199.9 to 999.9 °F with decimal point		
		K	K type: -240 to 1373 °C		
		K	K type: -400 to 2503 °F		
		K.C	K type: -128.8 to 537.7 °C with decimal point		
		K.F	K type: -199.9 to 999.9 °F with decimal point		
		L	L type: 0 to 762 °C		
		L	L type: 32 to 1403 °F		
		L.C	L type: 0.0 to 537.7 °C with decimal point		
L.F	L type: 32.0 to 999.9 °F with decimal point				



Parameter	Lower Display	Upper Display	Description	Default Value	When Visible
Input type and Range (Continued)		nC	N type: 0 to 1399 °C	Jc for Europe	Always
		nF	N type: 32 to 2551 °F		
		rC	R type: 0 to 1759 °C	JF for USA	
		rF	R type: 32 to 3198 °F		
		sC	S type: 0 to 1762 °C		
		sF	S type: 32 to 3204 °F		
		tC	T type: -240 to 400 °C		
		tF	T type: -400 to 752 °F		
		t.C	T type: -128.8 to 400.0 °C with decimal point		
		t.F	T type: -199.9 to 752.0 °F with decimal point		
		P24C	PtRh20% vs PtRh40%: 0 to 1850 °C		
		P24F	PtRh20% vs PtRh40%: 32 to 3362 °F		
		PtC	Pt100: -199 to 800 °C		
		PtF	Pt100: -328 to 1472 °F		
		Pt.C	Pt100: -128.8 to 537.7 °C with decimal point		
		Pt.F	Pt100: -199.9 to 999.9 °F with decimal point		
		0_20	0 to 20mA DC		
		4_20	4 to 20mA DC		
		0_50	0 to 50mV DC		
		10_50	10 to 50mV DC		
0_5	0 to 5V DC				
1_5	1 to 5V DC				
0_10	0 to 10V DC				
2_10	2 to 10V DC				
Scale Range Upper Limit	rUL	Scale Range Lower Limit +100 to Range Max	Linear inputs = 1000 (°C/°F = max range)	Always	
Scale Range Lower Limit	rLL	Range Min. to Scale range Upper Limit - 100	Linear = 0 (°C/°F = min range)	Always	

Parameter	Lower Display	Upper Display	Description	Default Value	When Visible
Decimal point position	dPo5	0	Decimal point position in non-temperature ranges. 0 = XXXX 1 = XXX.X 2 = XX.XX 3 = X.XXX	1	InPt = mV, V or mA
		1			
		2			
		3			
Process Variable Offset	OFF5	±Span of controller (see <b>CAUTION</b> note at end of section)		0	Always
Limit Action	Ctrl	H,	High Limit. <i>Limit relay is energised when process "safe" (PV &lt; Limit Setpoint)</i>	H,	Always
		Lo	Low Limit. <i>Limit relay is energised when process "safe" (PV &gt; Limit Setpoint)</i>		
Setpoint Upper Limit	SPUL	Current Setpoint value to Scale Range Maximum		Range Max.	Always
Setpoint Lower Limit	SPLL	Scale Range Minimum to current Setpoint value		Range Min	Always
Alarm 1 Type	ALA1	P_H,	Process High Alarm	P_H,	Always
		P_Lo	Process Low Alarm		
		dE	Deviation Alarm		
		bAnd	Band Alarm		
			No alarm		
Process High Alarm 1 value*	PHA1	Range Min. to Range Max.		Range Max.	ALA1 = P_H,
Process Low Alarm 1 value*	PLA1	Range Min. to Range Max		Range Min.	ALA1 = P_Lo
Deviation Alarm 1 Value*	dAL1	±span from setpoint		5	ALA1 = dE
Band Alarm 1 value*	bAL1	1 LSD to full span from setpoint.		5	ALA1 = bAnd
Alarm 1 Hysteresis*	AHY1	1 LSD to 100% of span (in display units) on "safe" side of alarm point.		1	Always
Alarm 2 Type	ALA2	As for alarm 1 type		P_Lo	Always
Process High Alarm 2 value*	PHA2	Range Min. to Range Max.		Range Max.	ALA2 = P_H,
Process Low Alarm 2 value*	PLA2	Range Min. to Range Max.		Range Min.	ALA2 = P_Lo
Deviation Alarm 2 Value*	dAL2	±span from setpoint.		5	ALA2 = dE
Band Alarm 2 value*		1 LSD to full span from setpoint.		5	ALA2 = bAnd

Parameter	Lower Display	Upper Display	Description	Default Value	When Visible
Alarm 2 Hysteresis*	<b>AH42</b>		1 LSD to 100% of span (in display units) on "safe" side of alarm point.	<b>1</b>	Always
Output 2 Usage	<b>USE2</b>	<b>L77t</b>	Limit Output Relay	<b>A2_d</b> when <b>OPn2</b> is not linear output type, <b>rEtP</b> if <b>OPn2</b> is linear output type	<b>OPn2 = rLY</b>
		<b>A1_d</b>	Alarm 1, Direct Acting		<i>Not linear</i>
		<b>A1_r</b>	Alarm 1, Reverse Acting		<i>Not linear</i>
		<b>A2_d</b>	Alarm 2, Direct Acting		<i>Not linear</i>
		<b>A2_r</b>	Alarm 2, Reverse Acting		<i>Not linear</i>
		<b>Or_d</b>	Logical Alarm 1 OR Alarm 2 Direct Acting		<i>Not linear</i>
		<b>Or_r</b>	Logical Alarm 1 OR Alarm 2 Reverse Acting		<i>Not linear</i>
		<b>Ar_d</b>	Logical Alarm 1 AND Alarm 2, Direct Acting		<i>Not linear</i>
		<b>Ar_r</b>	Logical Alarm 1 AND Alarm 2, Reverse Acting		<i>Not linear</i>
		<b>An_d</b>	Limit Annunciator, Direct Acting		<i>Not linear</i>
		<b>An_r</b>	Limit Annunciator, Reverse Acting		<i>Not linear</i>
		<b>rEtS</b>	Retransmit SP Output		<i>Linear only</i>
		<b>rEtP</b>	Retransmit PV Output		<i>Linear only</i>
Linear Output 2 Range	<b>tYP2</b>	<b>0_5</b>	0 to 5 V DC output 1	<b>0_10</b>	<b>OPn2 = L in</b>
		<b>0_10</b>	0 to 10 V DC output		
		<b>2_10</b>	2 to 10 V DC output		
		<b>0_20</b>	0 to 20 mA DC output		
		<b>4_20</b>	4 to 20 mA DC output		
Retransmit Output 2 Scale maximum	<b>ro2H</b>	<b>- 1999 to 9999</b> Display value where output is maximum	Range max	<b>USE2 = rEtS or rEtP</b>	
Retransmit Output 2 Scale minimum	<b>ro2L</b>	<b>- 1999 to 9999</b> Display value where output is minimum	Range min	<b>USE2 = rEtS or rEtP</b>	
Output 3 Usage	<b>USE3</b>	As for output 2	<b>A1_d</b>	<b>OPn3</b> is not <b>nonE</b>	
Linear Output 3 Range	<b>tYP3</b>	As for output 2	<b>0_10</b>	<b>OPn3 = L in</b>	

Parameter	Lower Display	Upper Display	Description	Default Value	When Visible
Retransmit Output 3 Scale maximum	ro3H	- 1999 to 9999 Display value where output is maximum		Range max	USE3 = rEt5 or rEtP
Retransmit Output 3 Scale minimum	ro3L	- 1999 to 9999 Display value where output is minimum		Range min	USE3 = rEt5 or rEtP
Display Strategy		EnAb	PV is visible in Operator mode	EnAb	Always
		d,SA	PV not visible in Operator mode		
		SAFE	Displays <b>SAFE</b> in Operator mode when Limit Output is not active		
Comms Protocol		ASC I	ASCII	r7bn	OPnA = r485
		r7bn	Modbus with no parity		
		r7bE	Modbus with Even Parity		
		r7bo	Modbus with Odd Parity		
Bit rate	bAud	1.2	1.2 kbps	4.8	OPnA = r485
		2.4	2.4 kbps		
			4.8 kbps		
		9.6	9.6 kbps		
		19.2	19.2 kbps		
Communications Address	Addr	1	A unique address for each instrument between 1 to 255 (Modbus), or 1 to 99 (Ascii)	1	OPnA = r485
Communications Write Enable	CoEn	r_o	Read only. Comms writes ignored	r_lw	Always
		r_lw	Read / Write. Writing via Comms is possible		
Configuration Mode Lock Code	CLoc	0 to 9999		20	Always

### Notes:

Option Slot 1 is a fixed Limit Relay output. A Digital Input module, if fitted to Option Slot A will duplicate the function of the front Reset key **RESET**. As these functions cannot be changed, configuration menus are not required.

Alarm parameters marked \* are repeated in Setup Mode.

### CAUTION:

**Process Variable Offset** modifies the measured value to compensate for probe errors. Positive values increase the reading, negative values are subtracted. This parameter is effectively, a calibration adjustment and **MUST** be used with care.

## DC120L Limit Controller – Setup Mode

This mode is normally selected only after Configuration Mode has been completed, and is used when a change to the process set up is required.

**Note:**

*Entry into Setup Mode is security-protected by the Setup Mode lock code.*

### Entry into the Setup Mode

Hold down and press to enter the Select Mode

Press or to navigate to the Setup Mode option, then press to enter Setup Mode.

The Setup LED will light while in Setup mode

### Scrolling through Parameters & Values

Press to scroll through the parameters (refer to the table below) and their values.

### Changing Parameter Values

Press to select the required parameter, then press or to set the value as required.

Once the displayed value is changed, the effect is immediate. No confirmation of the change is required.

**Note:**

*If there is no key activity for two minutes, the instrument returns to the operator mode.*

Table 22. Model DC120L Set Up Mode Parameters

Parameter	Lower Display	Upper Display Adjustment Range	Default Value	When Visible
Limit Setpoint value	SP	Scaled Range Minimum to Scaled Range Maximum	Range max when Ctrl=L=H, Range min when Ctrl=L=Lo	Always
Limit Hysteresis	HYSL	1 LSD to full span in display units, on the safe side of the limit SP	1	Always
Input Filter Time constant	FILT	OFF, 0.5 to 100.0 secs in 0.5 sec increments (see <b>CAUTION</b> note at end of section)	2.0	Always

Parameter	Lower Display	Upper Display Adjustment Range	Default Value	When Visible
Process High Alarm 1 value*	<b>PHR1</b>	Range Min. to Range Max.	Range Max.	<b>ALA1 = P_H ,</b>
Process Low Alarm 1 value*	<b>PLR1</b>	Range Min. to Range Max.	Range Min.	<b>ALA1 = P_Lo</b>
Deviation Alarm 1 Value*	<b>dAL1</b>	±span from setpoint	<b>5</b>	<b>ALA1 = dE</b>
Band Alarm 1 value*	<b>bAL1</b>	1 LSD to full span from setpoint.	<b>5</b>	<b>ALA1 = bAnd</b>
Alarm 1 Hysteresis*	<b>AHY1</b>	Up to 100% of span	<b>1</b>	Always
Process High Alarm 2 value*	<b>PHR2</b>	Range Min. to Range Max.	Range Max.	<b>ALA2 = P_H ,</b>
Process Low Alarm 2 value*	<b>PLR2</b>	Range Min. to Range Max.	Range Min.	<b>ALA2 = P_Lo</b>
Deviation Alarm 2 Value	<b>dAL2</b>	±span from setpoint	<b>5</b>	<b>ALA2 = dE</b>
Band Alarm 2 value*	<b>bAL2</b>	1 LSD to full span from setpoint.	<b>5</b>	<b>ALA2 = bAnd</b>
Alarm 2 Hysteresis*	<b>AHY2</b>	Up to 100% of span	<b>1</b>	Always
Set-up Lock Code	<b>SLoc</b>	0 to 9999	<b>10</b>	Always
**First Operator mode displays follows.				

**Note:**

*Alarm parameters marked \* are repeated in Configuration Mode.*

**Note:**

*\*\*Once the complete list of Set Up Mode parameters has been displayed, the first Operator Mode display is shown without exiting from Set Up Mode.*

**CAUTION:**

**An excessively large filter time could significantly delay detection of a limit condition. Set this value to the minimum required to remove noise from the process variable.**

## DC120L Limit Controller - Operator Mode

This is the mode used during normal operation of the instrument. It can be accessed from Select Mode, and is the usual mode entered at power-up.

### WARNING:

**IN NORMAL OPERATION, THE OPERATOR MUST NOT REMOVE THE INSTRUMENT FROM ITS HOUSING OR HAVE UNRESTRICTED ACCESS TO THE REAR TERMINALS, AS THIS WOULD PROVIDE POTENTIAL CONTACT WITH HAZARDOUS LIVE PARTS.**

### CAUTION:

**Set all Configuration Mode parameters and Setup Mode parameters as required before starting normal operations.**

### Navigating in Operator Mode



Press  to move between displays.

Table 23. Model DC120L Operator Mode Displays

Upper Display	Lower Display	When Visible	Description	
PV Value	Limit SP Value	Display strategy is set to <b>EnAb.</b> (Initial Screen)	Process Variable and Limit Setpoint values. <i>Read only</i>	
Limit SP Value	<i>Blank</i>	Display strategy is set to <b>d,SA.</b> (Initial Screen)	Limit Setpoint value only. <i>Read only</i>	
<b>SAFE</b> or <b>rSEt</b>	<i>Blank</i> or PV Value	Display strategy is set to <b>SAFE.</b> (Initial Screen)	Displays <b>SAFE</b> and <i>blank</i> if Limit Output is not active. Displays <b>rSEt</b> and Process Variable value if Limit Output is active. <i>Read only</i>	
High Limit Hold	<b>H Hd</b>	<b>[Ctrl = H]</b> in Configuration Mode	Highest PV value since this parameter was last reset.	
Low Limit Hold	<b>LoHd</b>	<b>[Ctrl = Lo]</b> in Configuration Mode	Lowest PV value since this parameter was last reset.	
Exceed Time Value	<b>t,</b>	Always available	Accumulated time of Limit SP exceed conditions since this parameter was last reset. Time Format: <i>mm.ss to 99.59, then mmm.s (10 sec increments)</i> Shows <b>[HH]</b> when $\geq 999.9$	
Active Alarm Status	<b>ALSt</b>	When any alarm is active.  <b>ALM</b> indicator will also flash	Upper display shows which alarm(s) are active. Inactive alarms are blank	
			<b>1</b>	Alarm 1 Active
			<b>2</b>	Alarm 2 Active
			<b>An</b>	Annunciator Active





### Limit Setpoint Adjustment

Adjustment of the Limit Setpoint can be only made from Setup Mode.

### Exceed Condition

An Exceed Condition occurs when the Process Variable exceeds the Limit Setpoint value (i.e. PV is greater than the Limit Setpoint when set for high limit action, PV is less than the Limit Setpoint for low limit action). The  LED is on during this condition, and is extinguished once it has passed.

### Limit Output Function

The Limit Output relay(s) de-energise whenever an Exceed condition occurs, causing the process to shut down. The  LED is on when the relay is de-energised. The relay remains latched off even if the Exceed condition is no longer present. A reset instruction must be given **after the exceed condition has passed** to re-energise the relay, allowing the process to continue. The  LED then turns off.

### Limit Annunciator Outputs

An Annunciator output will activate when an Exceed condition occurs, and will remain active until a reset instruction is received, or the Exceed condition has passed. Unlike the Limit Output, an Annunciator can be reset even if the Exceed condition is present. When an Annunciator is active, the  LED will flash and the Alarm Status screen is available.

### Resetting Limit Outputs & Annunciators

A reset instruction can be given by any of the following methods. The front panel Reset key, the Digital Input (if fitted) or via Serial Communications command if an RS485 Communications module is fitted.

#### Using The Reset Key To Reset Limit Outputs & Annunciators

Press the  key reset an active Annunciator or latched Limit Relay.

#### Note:

*Annunciators will deactivate immediately, Limit Outputs will only re-energise if the Exceed condition has passed.*

#### CAUTION:

**Ensure that the cause of the Exceed condition has been rectified before resetting the Limit Output.**



## **Resetting Limit Hold and Exceed Time**

The highest PV value reached (for High Limit action) or lowest PV value reached (for Low Limit action) and the accumulated time of Limit SP exceed conditions can be viewed.

### **To reset the stored Limit Hold and Exceed Time values**

Display the value to be reset, then press the  key for 5 seconds. The upper display briefly shows ---- when the value is reset.

### DC120L Controller – Serial Communications Parameters

The Modbus parameter addresses, and the possible ASCII message types and parameters indents for the Model DC120L are detailed below. RO indicates a parameter is read only, R/W indicates it can also be written to. Communications writes will not implemented if the Communications Write Parameter is disabled. Refer to the Modbus and ASCII Communications sections of this manual for details of the protocols used.

#### Bit Parameters

Bit parameters are not applicable to the ASCII protocol.

Table 24. Model DC120L Communications - Bit Parameters

Parameter	Modbus Parameter No.		Notes
Communication Write Status	1	RO	1 = Write Enabled, 0 = Write Disabled. A negative acknowledgement (exception code 3) is sent to write commands if communications writes are disabled
Limit Action	2	RO	1 = Low Limit, 0 = High Limit
Reset Limit Relay	3	R/W	1 = Reset Latched Relays. A read returns the values 0
Limit Status	4	RO	1 = In Exceed Condition, 0 = Not in Exceed Condition
Alarm 1 Status	5	RO	1 = Active, 0 = Inactive
Alarm 2 Status	6	RO	1 = Active, 0 = Inactive
Limit Output Status	7	RO	1 = Relay latched, 0 = Relay not latched
Annunciator Output Status	8	RO	1 = Active, 0 = Inactive

To set the bit value to 1 write FF, to set the bit value to 0 write 00. Refer to Function Code 05 in the Modbus Communications section.

#### Word Parameters

Table 25. Model DC120L Communications - Word Parameters

Parameter	Modbus Parameter No.		ASCII Ident & Message Types		Notes
Process Variable	1	RO	<b>M</b> Type 2	RO	Current value of PV.
					If under-range = 62976 (<??>5 ASCII)
					If over-range = 63232 (<??>0 ASCII)
					If Sensor break = 63488 (ASCII = n/a)
Limit Setpoint	2	R/W	<b>S</b> Type 2, 3/4	R/W	Value of the Limit Setpoint.
Hold Value	3	R/W	<b>A</b> Type 2	RO	Highest PV value (High Limit Action) or Lowest PV value (Low Limit Action) since this parameter was last reset. Modbus: Write any value to reset ASCII: See Controller Command 00160 for reset.

Parameter	Modbus Parameter No.		ASCII Ident & Message Types		Notes
Deviation	4	RO	V Type 2	RO	Difference between Process Variable and Limit Setpoint (value = PV-Limit SP)
Time Exceeded Value	5	R/W	T Type 2	RO	Accumulated time of Limit SP exceed conditions since this parameter was last reset. Modbus: Write any value to reset ASCII: See Controller Command 00170 for reset
Limit Hysteresis	6	R/W	F Type 2, 3/4	R/W	A band on the "safe" side of the Limit SP. Adjustable 0 to 100% of span. A latched limit relay cannot be reset until the process passes through this band
Alarm 1 Value	7	R/W	C Type 2, 3/4	R/W	Alarm 1 active at this level
Alarm 2 Value	8	R/W	E Type 2, 3/4	R/W	Alarm 2 active at this level
Scale Range Lower Limit	9	R/W	H Type 2 Type 3/4	RO R/W	Lower limit of scaled input range
Scale Range Upper Limit	10	R/W	G Type 2 Type 3/4	RO R/W	Upper limit of scaled input range
Decimal Point Position	11	R/W	Q Type 2 Type 3/4	RO R/W	Read only if not Linear Input. 0 = xxxx 1 = xxx.x 2 = xx.xx 3 = x.xxx
Input Filter Time Constant	12	R/W	m Type 2, 3/4	R/W	0 to 100 seconds
Re-transmit output Maximum	13	R/W	[ Type 2, 3/4	R/W	Maximum scale value for retransmit output, 1999 to 9999. This parameter applies to the first re-transmit output fitted (see also Modbus parameters 2224, 2225, 2234 & 2235).
Re-transmit Output Minimum	14	R/W	\ Type 2, 3/4	R/W	Minimum scale value for retransmit output, 1999 to 9999. This parameter applies to the first re-transmit output fitted (see also Modbus parameters 2224, 2225, 2234 & 2235).
Process Value Offset	26	R/W	v Type 2 Type 3/4	RO R/W	Modified PV = Actual PV + PV Offset. Limited by Scale Range Max. and Scale Range Min.
Alarm 1 Hysteresis	32	R/W			0 to 100% of span
Alarm 2 Hysteresis	33	R/W			0 to 100% of span

Parameter	Modbus Parameter No.		ASCII Ident & Message Types		Notes																												
Controller Commands			<b>Z</b> Type 3/4	R/W	The Type 3 {DATA} field must be one of three five-digit numbers: 00150 = Reset Limit Outputs 00160 = Reset Hold Value 00170 = Reset Exceed Time value The response contains the same {DATA}. A negative acknowledgement will be returned if Reset is not possible or already implemented.																												
Controller Status			<b>L</b> Type 2	RO	<table border="1"> <thead> <tr> <th>Bits</th> <th>Meaning</th> </tr> </thead> <tbody> <tr> <td>0</td> <td>Alarm 1 status: 0 = Activated, 1 = Safe</td> </tr> <tr> <td>1</td> <td>Alarm 2 status: 0 = Activated, 1 = Safe</td> </tr> <tr> <td>2</td> <td>Not used</td> </tr> <tr> <td>3</td> <td>Change Indicator: 0 = No changes, since Controller Status was last read. 1 = A parameter other than Controller Status or PV has changed</td> </tr> <tr> <td>4</td> <td>Comms write status: 0 = Disabled 1 = Enabled</td> </tr> <tr> <td>5</td> <td>Not used</td> </tr> <tr> <td>6</td> <td>Not used</td> </tr> <tr> <td>7</td> <td>Not used</td> </tr> <tr> <td>8</td> <td>Not used</td> </tr> <tr> <td>9</td> <td>Limit status: 0 = Not Exceeded, 1 = Exceeded</td> </tr> <tr> <td>10</td> <td>Limit Relay Status: 0 = safe, 1 = Latched Off</td> </tr> <tr> <td>11</td> <td>Limit Action: 0 = Low Limit, 1 = High Limit</td> </tr> <tr> <td>12</td> <td>Annunciator status: 0 = inactive, 1 = Active</td> </tr> </tbody> </table>	Bits	Meaning	0	Alarm 1 status: 0 = Activated, 1 = Safe	1	Alarm 2 status: 0 = Activated, 1 = Safe	2	Not used	3	Change Indicator: 0 = No changes, since Controller Status was last read. 1 = A parameter other than Controller Status or PV has changed	4	Comms write status: 0 = Disabled 1 = Enabled	5	Not used	6	Not used	7	Not used	8	Not used	9	Limit status: 0 = Not Exceeded, 1 = Exceeded	10	Limit Relay Status: 0 = safe, 1 = Latched Off	11	Limit Action: 0 = Low Limit, 1 = High Limit	12	Annunciator status: 0 = inactive, 1 = Active
					Bits	Meaning																											
					0	Alarm 1 status: 0 = Activated, 1 = Safe																											
					1	Alarm 2 status: 0 = Activated, 1 = Safe																											
					2	Not used																											
					3	Change Indicator: 0 = No changes, since Controller Status was last read. 1 = A parameter other than Controller Status or PV has changed																											
					4	Comms write status: 0 = Disabled 1 = Enabled																											
					5	Not used																											
					6	Not used																											
					7	Not used																											
					8	Not used																											
					9	Limit status: 0 = Not Exceeded, 1 = Exceeded																											
					10	Limit Relay Status: 0 = safe, 1 = Latched Off																											
11	Limit Action: 0 = Low Limit, 1 = High Limit																																
12	Annunciator status: 0 = inactive, 1 = Active																																
Scan Table			<b>J</b> Type 2	RO	Reads back main process values. Response is: L{N}25aaaaabbbbbccccddddddeeeeeA* where: aaaaa = Limit Setpoint value bbbbbb = Process Variable value cccccc = Hold value ddddd = Exceeded Time value eeeeee = Controller Status (see above)																												
Equipment ID		RO			The four digit model number 6700																												

Parameter	Modbus		ASCII Ident & Message Types		Notes	
	Parameter No.					
Serial Number Low	123	RO			Digits aaaa	Unit serial number. Format aaaa bbbb cccc, (12 BCD digits).
Serial Number Mid	124	RO			Digits bbbb	
Serial Number High	125	RO			Digits cccc	
Date of manufacture	126				Manufacturing date code as an encoded binary number. E.g. 0403 for April 2003 is returned as 193hex	
Product Revision Level		RO			Low Byte	Alpha part of PRL. E.g. A = 01hex
					High Byte	Numeric part of PRL. E.g. 13 = 0Dhex
Firmware Version	130	RO			<b>Bits</b>	<b>Meaning</b>
					0 - 4	Revision number (1,2...)
					5 - 9	Alpha version (A=0, B=1...)
					10 - 15	Numeric version (starting from 121 = 0)
Input status	133	RO			Input status. Read Only. Bit 0: Sensor break flag Bit 1: Under-range flag Bit 2: Over-range flag	
Option Slot 2 Re-transmit output Maximum	2224	R/W			Maximum scale value for retransmit output in slot 2, 1999 to 9999.	
Option Slot 2 Re-transmit output Minimum	2225	R/W			Minimum scale value for retransmit output in slot 2, 1999 to 9999.	
Option Slot 3 Re-transmit output Maximum	2234	R/W			Maximum scale value for retransmit output in slot 3, 1999 to 9999.	
Option Slot 3 Re-transmit output Minimum	2235	R/W			Minimum scale value for retransmit output in slot 3, 1999 to 9999.	

**Note:**

*Some of the parameters that do not apply to a particular configuration will accept reads and writes (e.g. attempting to scale a Linear output which has not been fitted). Read only parameters will return an exception if an attempt is made to write values to them.*

### 11 DI1700 Indicator

These 1/8 DIN (96 x 48mm) Indicators are ideal for most process monitoring applications. They are available with a red, green or Red/Green colour change display, plug-in modules for latching or non-latching relays, transmitter power output, or PV retransmission.

Red, Green or Colour Change display	Up to five Process Alarms
PV Retransmit option	Transmitter PSU option
Min/max Value hold	Remote Latched Relay reset
RS485 Modbus and ASCII comms	PC configuration option

#### DI1700 Indicator - Configuration Mode

This mode is normally used only when the indicator is configured for the first time or when a major change is made to the instruments characteristics. The Configuration Mode parameters must be set as required before adjusting parameters in Setup Mode, or attempting to use the in an application.

#### Entry into the Configuration Mode

**CAUTION:**

**Adjustments to these parameters should only be performed by personnel competent and authorised to do so.**

Configuration is entered from Select Mode

Hold down  and press  to force the controller into the Select Mode.

The **SLCt** legend is shown for 1 second, followed by the legend for the current mode.

Press  or  to navigate to the Configuration Mode option, then press .

**Note:**

*Entry into this mode is security-protected by the Configuration Mode Lock Code. Refer to the Unlock Code section for more details.*

**Note:**

*The Set LED  flashes in Configuration Mode.*

### Scrolling through Parameters and Values

Press **SETUP** to scroll through the parameters. While this key is pressed, and up to 1 second after, the parameter legend is shown, followed by the current parameter value.

**Note:**

Only parameters that are applicable to the hardware options chosen will be displayed.

### Changing Parameter Values

Press **SETUP** to navigate to the required parameter, then press **▲** or **▼** to set the value as required.

Once the desired value is set, press **SETUP** to display **YES?**, press **▲** within 10 seconds, accept the change, otherwise parameter will revert to previous value.

Or

Press **SETUP** to reject the change and to move onto the next parameter.

Hold down **SETUP** and press **▲** to return to Select Mode.

**Note:**

*If there is no key activity for 2 minutes the instrument returns to the operator mode.*

Table 26. DI1700 Configuration Mode Parameters

Parameter	Legend <i>for 1 sec followed by</i>	Set Value	Adjustment Range & Description	Default Value	When Visible	Units Display
Input type and Range	<b>InPt</b>	<b>bC</b>	B type: 100 to 1824 °C	<b>JC</b>  for Europe	Always	r
		<b>bF</b>	B type: 211 to 3315 °F			
		<b>C</b>	C type: 0 to 2320 °C			
		<b>CF</b>	C type: 32 to 4208 °F			
		<b>JC</b>	J type: -200 to 1200 °C			
		<b>JF</b>	J type: -328 to 2192 °F			
		<b>J.C</b>	J type: -128.8 to 537.7 °C with decimal point	<b>JF</b> for USA		
		<b>J.F</b>	J type: -199.9 to 999.9 °F with decimal point			
		<b>KC</b>	K type: -240 to 1373 °C			
		<b>KF</b>	K type: -400 to 2503 °F			
		<b>K.C</b>	K type: -128.8 to 537.7 °C with decimal point			
		<b>K.F</b>	K type: -199.9 to 999.9 °F with decimal point			

Parameter	Legend <i>for 1 sec followed by</i> →	Set Value	Adjustment Range & Description	Default Value	When Visible	Units Display
Input type and Range (Continued)		<b>LC</b>	L type: 0 to 762 °C	<b>JC</b>	Always	r
		<b>LF</b>	L type: 32 to 1403 °F			
		<b>L.C</b>	L type: 0.0 to 537.7 °C with decimal point	<b>JF</b> for USA		
		<b>L.F</b>	L type: 32.0 to 999.9 °F with decimal point			
		<b>NC</b>	N type: 0 to 1399 °C			
		<b>NF</b>	N type: 32 to 2551 °F			
		<b>rC</b>	R type: 0 to 1759 °C			
		<b>rF</b>	R type: 32 to 3198 °F			
		<b>SC</b>	S type: 0 to 1762 °C			
		<b>SF</b>	S type: 32 to 3204 °F			
		<b>tC</b>	T type: -240 to 400 °C			
		<b>tF</b>	T type: -400 to 752 °F			
		<b>t.C</b>	T type: -128.8 to 400.0 °C with decimal point			
		<b>t.F</b>	T type: -199.9 to 752.0 °F with decimal point			
		<b>P24C</b>	PtRh20% vs PtRh40%: 0 to 1850 °C			
		<b>P24F</b>	PtRh20% vs PtRh40%: 32 to 3362 °F			
		<b>PtC</b>	Pt100: -199 to 800 °C			
		<b>PtF</b>	Pt100: -328 to 1472 °F			
		<b>Pt.C</b>	Pt100: -128.8 to 537.7 °C with decimal point			
		<b>Pt.F</b>	Pt100: -199.9 to 999.9 °F with decimal point			
		<b>0_20</b>	0 to 20mA DC			
		<b>4_20</b>	4 to 20mA DC			
		<b>0_50</b>	0 to 50mV DC			
		<b>10_50</b>	10 to 50mV DC			
	<b>0_5</b>	0 to 5V DC				
	<b>1_5</b>	1 to 5V DC				
	<b>0_10</b>	0 to 10V DC				
			2 to 10V DC			



Parameter	Legend <i>for 1 sec followed by</i>	Set Value	Adjustment Range & Description	Default Value	When Visible	Units Display
Scale Range Upper Limit	<b>rUL</b>		Scale Range Lower Limit +100 to Range Max	Linear = 1000 °C/°F = max range	Always	<b>u</b>
Scale Range Lower Limit	<b>rLL</b>		Range Min. to Scale range Upper Limit - 100	Linear = 0 °C/°F = min range	Always	<b>L</b>
Decimal point position	<b>dPoS</b>	<b>0</b>	Decimal point position in non-temperature ranges. 0 = <b>XXXX</b> 1 = <b>XXX.X</b> 2 = <b>XX.XX</b> 3 = <b>X.XXX</b>	<b>1</b>	<b>InPt</b> = mV, V or mA	<b>P</b>
		<b>1</b>				
		<b>2</b>				
		<b>3</b>				
Linear Range Engineering Units Display	<b>L inU</b>	<b>nonE</b>	<b>nonE</b> (Blank), <b>C</b> = °C or <b>F</b> = °F For use where linear inputs represent temperature.	<b>nonE</b>	<b>InPt</b> = mV, V or mA	<b>C</b>
		<b>C</b>				<b>F</b>
		<b>F</b>				
Multi-Point Scaling	<b>mPS</b>	<b>EnAb</b>	<b>d,SA</b> disabled or <b>EnAb</b> enabled	<b>d,SA</b>	Always	<b>S</b>
		<b>d,SA</b>				
Alarm 1 Type	<b>ALA1</b>	<b>P_H,</b>	Process High Alarm	<b>P_H,</b>	Always	<b>1</b>
		<b>P_Lo</b>	Process Low Alarm			
		<b>nonE</b>	No alarm			
Process High Alarm 1 value*	<b>PHA1</b>		Range Min. to Range Max. <i>Parameter repeated in Setup Mode</i>	Range Max.	<b>ALA1 = P_H,</b>	<b>A</b> if alarm 1 only or <b>1</b>
Process Low Alarm 1 value*	<b>PLA1</b>		Range Min. to Range Max. <i>Parameter repeated in Setup Mode</i>	Range Min.	<b>ALA1 = P_Lo</b>	
Alarm 1 Hysteresis*	<b>AHY1</b>		1 LSD to 100% of span (in display units) on "safe" side of alarm point. <i>Parameter repeated in Setup Mode</i>	<b>1</b>	<b>ALA1</b> is not <b>nonE</b>	<b>-</b>
Alarm 2 Type	<b>ALA2</b>		As for alarm 1 type	<b>nonE</b>	Always	<b>2</b>
Process High Alarm 2 value*	<b>PHA2</b>		Range Min. to Range Max. <i>Parameter repeated in Setup Mode</i>	Range Max.	<b>ALA2 = P_H,</b>	<b>2</b>
Process Low Alarm 2 value*	<b>PLA2</b>		Range Min. to Range Max. <i>Parameter repeated in Setup Mode</i>	Range Min.	<b>ALA2 = P_Lo</b>	
Alarm 2 Hysteresis*	<b>AHY2</b>		1 LSD to 100% of span (in display units) on "safe" side of alarm point. <i>Parameter repeated in Setup Mode</i>	<b>1</b>	<b>ALA2</b> is not <b>nonE</b>	<b>=</b>

Parameter	Legend <i>for 1 sec followed by</i> →	Set Value	Adjustment Range & Description	Default Value	When Visible	Units Display
Alarm 3 Type	<b>ALA3</b>		As for alarm 1 type	<b>nonE</b>	Always	<b>3</b>
Process High Alarm 3 value*	<b>PHA3</b>		Range Min. to Range Max. <i>Parameter repeated in Setup Mode</i>	Range Max.	<b>ALA3 = P_H</b>	<b>3</b>
Process Low Alarm 3 value*	<b>PLA3</b>		Range Min. to Range Max. <i>Parameter repeated in Setup Mode</i>	Range Min.	<b>ALA3 = P_Lo</b>	
Alarm 3 Hysteresis*	<b>AHY3</b>		1 LSD to 100% of span (in display units) on "safe" side of alarm point. <i>Parameter repeated in Setup Mode</i>	<b>1</b>	<b>ALA3</b> is not <b>nonE</b>	<b>3</b>
Alarm 4 Type	<b>ALA4</b>		As for alarm 1 type	<b>nonE</b>	Always	<b>4</b>
Process High Alarm 4 value*	<b>PHA4</b>		Range Min. to Range Max. <i>Parameter repeated in Setup Mode</i>	Range Max.	<b>ALA4 = P_H</b>	<b>4</b>
Process Low Alarm 4 value*	<b>PLA4</b>		Range Min. to Range Max. <i>Parameter repeated in Setup Mode</i>	Range Min.	<b>ALA4 = P_Lo</b>	
Alarm 4 Hysteresis*	<b>AHY4</b>		1 LSD to 100% of span (in display units) on "safe" side of alarm point. <i>Parameter repeated in Setup Mode</i>	<b>1</b>	<b>ALA4</b> is not <b>nonE</b>	<b>4</b>
Alarm 5 Type	<b>ALA5</b>		As for alarm 1 type	<b>nonE</b>	Always	<b>5</b>
Process High Alarm 5 value*	<b>PHA5</b>		Range Min. to Range Max. <i>Parameter repeated in Setup Mode</i>	Range Max.	<b>ALA5 = P_H</b>	<b>5</b>
Process Low Alarm 5 value*	<b>PLA5</b>		Range Min. to Range Max. <i>Parameter repeated in Setup Mode</i>	Range Min.	<b>ALA5 = P_Lo</b>	
Alarm 5 Hysteresis*	<b>AHY5</b>		1 LSD to 100% of span (in display units) on "safe" side of alarm point. <i>Parameter repeated in Setup Mode</i>	<b>1</b>	<b>ALA5</b> is not <b>nonE</b>	<b>5</b>
Output 1 Usage	<b>USE 1</b>	<b>A 1nd</b>	Alarm 1, direct, non-latching	<b>A 1nd</b> when <b>OPn 1</b> is not linear output type, <b>rEtP</b> if <b>OPn 1</b> is linear output type	<b>OPn 1</b> is not linear or empty	<b>1</b>
		<b>A 1nr</b>	Alarm 1, reverse, non-latching			
		<b>A 1Ld</b>	Alarm 1, direct, latching			
		<b>A 1Lr</b>	Alarm 1, reverse, latching			
		<b>A 2nd</b>	Alarm 2, direct, non-latching			
		<b>A 2nr</b>	Alarm 2, reverse, non-latching			
		<b>A 2Ld</b>	Alarm 2, direct, latching			
		<b>A 2Lr</b>	Alarm 2, reverse, latching			
		<b>A 3nd</b>	Alarm 3, direct, non-latching			
		<b>A 3nr</b>	Alarm 3, reverse, non-latching			
		<b>A 3Ld</b>	Alarm 3, direct, latching			
		<b>A 3Lr</b>	Alarm 3, reverse, latching			

Parameter	Legend <i>for 1 sec followed by</i> →	Set Value	Adjustment Range & Description	Default Value	When Visible	Units Display
Output 1 Usage (Continued)		A4nd	Alarm 4, direct, non-latching	A Ind when OPn I is not linear output type, rEtP if OPn I is linear output type	OPn I is not linear or empty	I
		A4nr	Alarm 4, reverse, non-latching			
		A4Ld	Alarm 4, direct, latching			
		A4Lr	Alarm 4, reverse, latching			
		A5nd	Alarm 5, direct, non-latching			
		A5nr	Alarm 5, reverse, non-latching			
		A5Ld	Alarm 5, direct, latching			
		A5Lr	Alarm 5, reverse, latching			
		0 12d	Logical Alarm 1 OR 2, direct			
		0 12r	Logical Alarm 1 OR 2, reverse			
		0 13d	Logical Alarm 1 OR 3, direct			
		0 13r	Logical Alarm 1 OR 3, reverse			
		0 23d	Logical Alarm 2 OR 3, direct			
		0 23r	Logical Alarm 2 OR 3, reverse			
		A nYd	Any active alarm, direct			
		A nYr	Any active alarm, reverse			
rEtP	Retransmit PV Output				OPn I is linear output type	
dc 10	0 to 10VDC (adjustable) transmitter power supply*					
Output 1 PV Retransmit Type	tYP I	0_5	0 to 5 V DC output 1	0_10	USE I = rEtP	I
		0_10	0 to 10 V DC output			
		2_10	2 to 10 V DC output			
			0 to 20 mA DC output			
		4_20	4 to 20 mA DC output			
Retransmit Output 1 Scale maximum	ro IH	- 1999 to 9999 Display value where output is maximum	Range max	USE I = rEtP	H	
Retransmit Output 1 Scale minimum	ro IL	- 1999 to 9999 Display value where output is minimum	Range min	USE I = rEtP	L	
Output 1 TxPSU voltage level	PSU I	0 to 10VDC transmitter power supply output in 0.1V steps*	10.0	USE I = dc 10	I	

Parameter	Legend <i>for 1 sec followed by</i> by 	Set Value	Adjustment Range & Description	Default Value	When Visible	Units Display
Output 2 Usage	<b>USE2</b>		As for Output 1 usage	<b>A2nd</b> or <b>rEtP</b>	<b>OPn2</b> is not empty	<b>2</b>
Output 2 PV Retransmit Type	<b>tYP2</b>	<b>0_5</b>	0 to 5 V DC output 1	<b>0_10</b>	<b>USE2 = rEtP</b>	<b>2</b>
		<b>0_10</b>	0 to 10 V DC output			
		<b>2_10</b>	2 to 10 V DC output			
		<b>0_20</b>	0 to 20 mA DC output			
		<b>4_20</b>	4 to 20 mA DC output			
Retransmit Output 2 Scale maximum	<b>ro2H</b>	<b>- 1999 to 9999</b> Display value where output is maximum	Range max	<b>USE2 = rEtP</b>	<b>H</b>	
Retransmit Output 2 Scale minimum	<b>ro2L</b>	<b>- 1999 to 9999</b> Display value where output is minimum	Range min	<b>USE2 = rEtP</b>	<b>L</b>	
Output 2 TxPSU voltage level	<b>PSU2</b>	0 to 10VDC transmitter power supply output in 0.1V steps*		<b>10.0</b>	<b>USE2 = dc 10</b>	<b>2</b>
Output 3 Usage	<b>USE3</b>		As for Output 1 usage	<b>A3nd</b> or <b>rEtP</b>	<b>OPn3</b> is not empty	<b>3</b>
Output 3 PV Retransmit Type		<b>0_5</b>	0 to 5 V DC output 1	<b>0_10</b>	<b>USE3 = rEtP</b>	<b>3</b>
			0 to 10 V DC output			
		<b>2_10</b>	2 to 10 V DC output			
		<b>0_20</b>	0 to 20 mA DC output			
		<b>4_20</b>	4 to 20 mA DC output			
Retransmit Output 3 Scale maximum	<b>ro3H</b>	<b>- 1999 to 9999</b> Display value where output is maximum	Range max	<b>USE3 = rEtP</b>	<b>H</b>	
Retransmit Output 3 Scale minimum	<b>ro3L</b>	<b>- 1999 to 9999</b> Display value where output is minimum	Range min	<b>USE3 = rEtP</b>	<b>L</b>	
Output 3 TxPSU voltage level	<b>PSU3</b>	0 to 10VDC transmitter power supply output in 0.1V steps*		<b>10.0</b>	<b>USE3 = dc 10</b>	<b>3</b>
Output 4 Usage	<b>USE4</b>		Alarm output options as for Output 1 usage ( <i>Linear retransmit and PSU not possible</i> )	<b>A4nd</b>	<b>OPn4 = drLY</b>	<b>4</b>
Output 5 Usage	<b>USE5</b>		Alarm output options as for Output 1 usage ( <i>Linear retransmit and PSU not possible</i> )	<b>A5nd</b>	<b>OPn5 = drLY</b>	<b>5</b>

Parameter	Legend <i>for 1 sec followed by</i> →	Set Value	Adjustment Range & Description	Default Value	When Visible	Units Display
Display Strategy	dISP	0, 1, 2, 3, 4 or 6 <i>(see Operator Mode for details)</i>		0	Always	d
Display Colour	CLor	rEd	Permanent Red	G-r	If colour change display fitted	c
		Grn	Permanent Green			
		r-G	Red to Green if any alarm active			
		G-r	Green to Red if any alarm active			
Comms Protocol	Prot	ASC I	ASCII	r7bn	OPnA = r485	P
			Modbus with no parity			
		r7bE	Modbus with Even Parity			
		r7bo	Modbus with Odd Parity			
Bit rate	bAud	1.2	1.2 kbps	4.8	OPnA = r485	b
		2.4	2.4 kbps			
		4.8	4.8 kbps			
		9.6	9.6 kbps			
		19.2	19.2 kbps			
Communications Address	Addr	1	A unique address for each instrument between 1 to 255 (Modbus), or 1 to 99 (Ascii)	1	OPnA = r485	A
Communications Write Enable	CoEn	r_o	Read only. Comms writes ignored	r_w	Always	E
		r_w	Read / Write. Writing via Comms is possible			
Digital Input Usage	dIGI	rrLY	Reset latched relay(s)	rrLY	OPnA = dIGI	i
		tArE	Initiate Tare (zero display)			
		rPU	Reset min/max PV values			
		rE	Reset Alarm 1 elapsed time			
		rPUe	Reset Alarm 1 elapsed time & min/max PV values			
Configuration Mode Lock Code	CLoc	0 to 9999		20	Always	C

**Note:**

*\*Linear Outputs can be configured to provide an adjustable 0.0 to 10.0VDC transmitter power supply for external devices. This is an alternative to the fixed 24V Transmitter Power Supply option module.*

### DI1700 Indicator - Setup Mode

This mode is normally selected only after Configuration Mode has been completed, or is used when a change to the process set up is required. These parameters must be set as required before attempting to use the indicator in an application.

#### Entry into the Setup Mode

Setup Mode is entered from Select Mode

Hold down  and press  to force the controller into the Select Mode.

The **SLCT** legend is shown for 1 second, followed by the legend for the current mode.

Press  or  to navigate to the Setup Mode option, then press .

#### Note:

*Entry into Setup Mode is security-protected by the Setup Mode lock code. Refer to the Unlock Code section for more details.*



#### Note:

*The Set LED  is on in Setup Mode.*

#### Scrolling through Parameters and Values

Press  to scroll through the parameters. While this key is pressed, and up to 1 second after, the parameter legend is shown, followed by the current parameter value.

#### Changing Parameter Values

Press  to select the required parameter, then press  or  to set the value as required.

Once the displayed value is changed, it is effective immediately. No confirmation of the change is required.

Press  to move onto the next parameter.

Hold down  and press  to return to Select Mode.

#### Note:

*If there is no key activity for two minutes the instrument returns to the operator mode.*



Table 27. DI1700 Set Up Mode Parameters

Parameter	Legend <i>for 1 sec followed by</i>	Set Value	Adjustment Range & Description	Default Value	When Visible	Units Display
Input Filter Time constant	<b>FILT</b>	OFF, 0.5 to 100.0 seconds in 0.5 sec increments		<b>2.0</b>	Always	<b>t</b>
Process Variable Offset	<b>OFFS</b>	±Instrument Span		<b>0</b>	Always	<b>o</b>
Raw Process Variable value	<b>SG</b>	The un-scaled value of the input signal in mV, V or mA DC as defined by the input range and type. Resolution to 1 decimal place (e.g. 4.0 to 20.0mA). <i>This parameter is Read Only</i>			<b>InPt</b> = mV, V or mA	<b>blank</b>
Process High Alarm 1 value*	<b>PHA1</b>	Range Min. to Range Max. <i>Repeat of Configuration Mode parameter</i>	Range Max.	<b>ALA1 = P_H1</b>	<b>A</b> if alarm 1 only or <b>1</b>	
Process Low Alarm 1 value*	<b>PLA1</b>	Range Min. to Range Max. <i>Repeat of Configuration Mode parameter</i>	Range Min.	<b>ALA1 = P_Lo</b>		
Alarm 1 Hysteresis*	<b>AHY1</b>	1 LSD to 100% of span (in display units) on “safe” side of alarm point. <i>Repeat of Configuration Mode parameter</i>	<b>1</b>	<b>ALA1</b> is not <b>nonE</b>	<b>-</b>	
Process High Alarm 2 value*	<b>PHA2</b>	Range Min. to Range Max. <i>Repeat of Configuration Mode parameter</i>	Range Max.	<b>ALA2 = P_H1</b>	<b>2</b>	
Process Low Alarm 2 value*	<b>PLA2</b>	Range Min. to Range Max. <i>Repeat of Configuration Mode parameter</i>	Range Min.	<b>ALA2 = P_Lo</b>		
Alarm 2 Hysteresis*	<b>AHY2</b>	1 LSD to 100% of span (in display units) on “safe” side of alarm point. <i>Repeat of Configuration Mode parameter</i>	<b>1</b>	<b>ALA2</b> is not <b>nonE</b>	<b>=</b>	
Process High Alarm 3 value*	<b>PHA3</b>	Range Min. to Range Max. <i>Repeat of Configuration Mode parameter</i>	Range Max.	<b>ALA3 = P_H1</b>	<b>3</b>	
Process Low Alarm 3 value*	<b>PLA3</b>	Range Min. to Range Max. <i>Repeat of Configuration Mode parameter</i>	Range Min.	<b>ALA3 = P_Lo</b>		
Alarm 3 Hysteresis*	<b>AHY3</b>	1 LSD to 100% of span (in display units) on “safe” side of alarm point. <i>Repeat of Configuration Mode parameter</i>	<b>1</b>	<b>ALA3</b> is not <b>nonE</b>	<b>=</b>	
Process High Alarm 4 value*	<b>PHA4</b>	Range Min. to Range Max. <i>Repeat of Configuration Mode parameter</i>	Range Max.	<b>ALA4 = P_H1</b>	<b>4</b>	
Process Low Alarm 4 value*	<b>PLA4</b>	Range Min. to Range Max. <i>Repeat of Configuration Mode parameter</i>	Range Min.	<b>ALA4 = P_Lo</b>		
Alarm 4 Hysteresis*	<b>AHY4</b>	1 LSD to 100% of span (in display units) on “safe” side of alarm point. <i>Repeat of Configuration Mode parameter</i>	<b>1</b>	<b>ALA4</b> is not <b>nonE</b>	<b>4</b>	

Parameter	Legend <i>for 1 sec followed by</i> 	Set Value	Adjustment Range & Description	Default Value	When Visible	Units Display
Process High Alarm 5 value*	<b>PHAS</b>	Range Min. to Range Max. <i>Repeat of Configuration Mode parameter</i>	Range Max.	Range Max.	<b>ALAS = P_H</b>	<b>5</b>
Process Low Alarm 5 value*	<b>PLAS</b>	Range Min. to Range Max. <i>Repeat of Configuration Mode parameter</i>	Range Min.	Range Min.	<b>ALAS = P_Lo</b>	
Alarm 5 Hysteresis*	<b>AHYS</b>	1 LSD to 100% of span (in display units) on "safe" side of alarm point. <i>Repeat of Configuration Mode parameter</i>		<b>1</b>	<b>ALAS</b> is not <b>nonE</b>	<b>5</b>
Scaling Breakpoint 1	<b>ScA1</b>	Multi-point scaling breakpoint 1 value, adjustable from <b>0</b> to <b>100</b> in % of span		<b>100</b>	<b>PPPS = EnAb</b>	<b>1</b>
Display Value 1	<b>d,51</b>	Value to be displayed at multi-point scaling breakpoint 1, in display units		Range Max.		
Scaling Breakpoint 2	<b>ScA2</b>	Multi-point scaling breakpoint 2, adjustable up to 100% of span. Must be <b>&gt;ScA1</b> value			<b>PPPS = EnAb</b>	<b>2</b>
Display Value 2		Value to be displayed at Multi-point scaling breakpoint 2, in display units				
Scaling Breakpoint 3	<b>ScA3</b>	Multi-point scaling breakpoint 3, adjustable up to 100% of span. Must be <b>&gt;ScA2</b> value			<b>PPPS = EnAb</b>	<b>3</b>
Display Value 3	<b>d,53</b>	Value to be displayed at Multi-point scaling breakpoint 3, in display units				
Scaling Breakpoint 4	<b>ScA4</b>	Multi-point scaling breakpoint 4, adjustable up to 100% of span. Must be <b>&gt;ScA3</b> value			<b>PPPS = EnAb</b>	<b>4</b>
Display Value 4	<b>d,54</b>	Value to be displayed at Multi-point scaling breakpoint 4, in display units				
Scaling Breakpoint 5	<b>ScA5</b>	Multi-point scaling breakpoint 5, adjustable up to 100% of span. Must be <b>&gt;ScA4</b> value			<b>PPPS = EnAb</b>	<b>5</b>
Display Value 5	<b>d,55</b>	Value to be displayed at Multi-point scaling breakpoint 5, in display units				
Scaling Breakpoint 6	<b>ScA6</b>	Multi-point scaling breakpoint 6, adjustable up to 100% of span. Must be <b>&gt;ScA5</b> value			<b>PPPS = EnAb</b>	<b>6</b>
Display Value 6	<b>d,56</b>	Value to be displayed at Multi-point scaling breakpoint 6, in display units				
Scaling Breakpoint 7	<b>ScA7</b>	Multi-point scaling breakpoint 7, adjustable up to 100% of span. Must be <b>&gt;ScA6</b> value			<b>PPPS = EnAb</b>	<b>7</b>
Display Value 7	<b>d,57</b>	Value to be displayed at Multi-point scaling breakpoint 7, in display units				
Scaling Breakpoint 8	<b>ScA8</b>	Multi-point scaling breakpoint 8, adjustable up to 100% of span. Must be <b>&gt;ScA7</b> value			<b>PPPS = EnAb</b>	<b>8</b>
Display Value 8	<b>d,58</b>	Value to be displayed at Multi-point scaling breakpoint 8, in display units				



Parameter	Legend <i>for 1 sec followed by</i>	Set Value	Adjustment Range & Description	Default Value	When Visible	Units Display
Scaling Breakpoint 9	<b>ScA9</b>		Multi-point scaling breakpoint 9, adjustable up to 100% of span. Must be > <b>ScA8</b> value		<b>PP5 = EnAb</b>	<b>9</b>
Display Value 9	<b>d .59</b>		Value to be displayed at Multi-point scaling breakpoint 9, in display units			
Tare Function	<b>tArE</b>	<b>EnAb</b>	Enables or disables the input auto-zero Tare feature	<b>d .5A</b>	Always	<b>r</b>
		<b>d .5A</b>				
Set-up Lock Code	<b>SLoc</b>	<b>0 to 9999</b>		<b>10</b>	Always	<b>5</b>

\*\*Operator mode displays follows.

**Note:**

*Alarm parameters marked \* are repeated in Configuration Mode.*

**Note:**

*\*\*Once the complete list of Set Up Mode parameters has been displayed, the Operator Mode displays are shown without exiting from Set Up Mode.*

### DI1700 Indicator - Operator Mode

This is the mode used during normal operation of the instrument. It can be accessed from Select Mode, and is the usual mode entered at power-up. The available displays are dependent upon the setting of the Display Strategy parameter in Configuration Mode.

#### WARNING:

**IN NORMAL OPERATION, THE OPERATOR MUST NOT REMOVE THE INSTRUMENT FROM ITS HOUSING OR HAVE UNRESTRICTED ACCESS TO THE REAR TERMINALS, AS THIS WOULD PROVIDE POTENTIAL CONTACT WITH HAZARDOUS LIVE PARTS.**

#### CAUTION:

**Set all Configuration Mode parameters and Set Up Mode parameters as required before starting normal operations.**

### Entry into Operator Mode

This is the normal operating mode of the instrument from power-up. It can also be accessed from any other mode via Select Mode as follows:

Hold down  and press  to force the controller into the Select Mode.



The **SLCT** legend is shown for 1 second, followed by the legend for the current mode.

Press  or  to navigate to the Operator Mode option, then press .

### Scrolling through Parameters and Values

Press  to scroll through the parameters. While this key is pressed, and up to 1 second after, the parameter legend is shown, followed by the current parameter value.

### Changing Parameter Values

Press  to select the required parameter, then press  or  to set the value as required.

Once the displayed value is changed, it is effective immediately. No confirmation of the change is required.

Press  to move onto the next parameter.

#### Note:

*The operator can freely view the parameters in this mode, but alteration depends on the Display strategy setting in Configuration Mode. All parameters in Display strategy 6 are read only, and can only be adjusted via Setup mode.*

Table 28. DI1700 Operator Mode Displays

Parameter	Legend <i>for 1 sec followed by</i> →	Set Value	Adjustment Range & Description	Display Strategy & When Visible	Units Display	
Process Variable	<b>Proc</b>		Current Process Variable value <i>Read only, but latched relays can be reset (*see below)</i>	Always	C, F or blank	
Maximum PV Value	<b>MA</b>		Maximum displayed value (inc <b>[HH]</b> or <b>OPEN</b> ) since <b>MA</b> was last reset. Max LED  is lit	Strategies 0, 1, 3, 4, & 6	C, F or blank	
Minimum PV Value	<b>MI</b>		Minimum displayed value (inc <b>[LL]</b> or <b>OPEN</b> ) since <b>MI</b> was last reset. Min LED  is lit	Strategies 0, 1, 3, 4, & 6	C, F or blank	
Alarm 1 Active Time	<b>Et</b>		Accumulated time alarm 1 has been active since <b>Et</b> was last reset. Format <i>mm.ss to 99.59 then mmm.s (10 sec increments)</i> Shows <b>[HH]</b> if >999.9	Strategies 0, 4 & 6 if alarm 1 configured.	E	
Process Alarm 1 value	<b>AL1</b>		Alarm 1 value. <i>Adjustable except in Strategy 6</i>	Strategies 2, 3, 4 & 6 if alarm 1 configured	A if alarm 1 only or 1	
Process Alarm 2 value	<b>AL2</b>		Alarm 2 value. <i>Adjustable except in Strategy 6</i>	Strategies 2, 3, 4 & 6 if alarm 2 configured	2	
Process Alarm 3 value*	<b>AL3</b>		Alarm 3 value. <i>Adjustable except in Strategy 6</i>	Strategies 2, 3, 4 & 6 if alarm 3 configured	3	
Process Alarm 4 value	<b>AL4</b>		Alarm 4 value. <i>Adjustable except in Strategy 6</i>	Strategies 2, 3, 4 & 6 if alarm 4 configured	4	
Process Alarm 5 value*	<b>AL5</b>		Alarm 5 value. <i>Adjustable except in Strategy 6</i>	Strategies 2, 3, 4 & 6 if alarm 5 configured	5	
Active Alarm Status	<b>ALSt</b>	The alarm status screen indicates any active alarms.   When alarms are active, the associated Alarm LED flashes. <i>Latched relays can be reset (see below)</i>	Display(s) show active alarms. Inactive alarms are blank			
				1	Alarm 1 Active	1
			2	2	Alarm 2 Active	
			3	3	Alarm 3 Active	
			4	4	Alarm 4 Active	
			5	5	Alarm 5 Active	

### Indicator Units Display

The DI1700 indicators have an additional Units Display. In Operator Mode, this display shows °C or °F when a temperature input range is displayed, and is blank for linear inputs. The units display is also used in other modes as a confirmation of the parameter type currently shown in the main display.

### Alarm Indications





The alarm status screen indicates any active alarms, in addition the associated Alarm LED flashes.

For latching alarm outputs, the LED **FLASHES** when the alarm condition exists, and goes to **ON** when the alarm condition is no longer present if the output has not yet been reset, to indicate that the relay is in the Latched on condition.

### Resetting Latched Alarm Outputs

Latched outputs can be reset whilst the Process variable or Alarm Status screens are displayed, via the Digital Input (if fitted), with a communications command via the RS485 module (if fitted) or from the front keypad as follows:

Press either  or  to reset the latched relay(s).

**Note:**

*Outputs will only reset if their alarm condition is no longer present.*

**CAUTION:**

**A reset will affect ALL latched outputs.**

### Resetting Alarm 1 Active Time, Minimum PV or Maximum PV

The stored Maximum PV value, Minimum PV value or Alarm 1 active Elapsed Time value can be reset via the Digital Input (if fitted), with a communications command via the RS485 module (if fitted) or from the front keypad as follows:

Press  to select the parameter to be reset.

Press either  or  for three seconds.

The display briefly shows ---- when the value is reset before the unit reverts to the requested display.

## Multi-Point Scaling

When Multi-Point Scaling is enabled ( $MP5 = EnAb$  in Configuration Mode), up to 9 breakpoints can be set to linearize the input signal. This only applies to mA, mV or Voltage input types.

For each breakpoint the input scale value ( $ScAn$ ) is entered in % of input span, followed by the value to be shown ( $dSn$ ) in display units. Each breakpoint's input scale value must be higher than the previous value, but the display values can be either higher or lower. Any scale value set to 100% becomes the last in the series.

## Tare Feature

When Tare is enabled ( $tArE = EnAb$  in Configuration Mode), it can be used to set the displayed value to zero automatically, by making the PV Offset parameter equal, but opposite to, the current process variable value.

Tare can be initiated via the Digital Input (if fitted), with a communications command via the RS485 module (if fitted) or by using the following key press sequence:

Press  until the process variable is displayed.

Hold down  and  together for three seconds until the display shows **YES?**

Release both keys and press  within 3 seconds to confirm the request.

### Note:

*The Tare request is aborted if this sequence is not followed exactly.*

### DI1700 Indicator – Serial Communications Parameters

The Modbus parameter addresses, and the possible ASCII message types and parameters indents for the DI1700 are detailed below. RO indicates a parameter is read only, WO indicates a parameter is write only and R/W indicates it can read from or written to. Communications writes will not implemented if the Communications Write Parameter is disabled. Refer to the Modbus and ASCII Communications sections of this manual for details of the protocols used.

#### Bit Parameters

Bit parameters are not applicable to the ASCII protocol.

Table 29. DI1700 Communications - Bit Parameters

Parameter	Modbus Parameter No.		Notes
Alarm 1 Status	1	RO	1 = Active, 0 = Inactive
Alarm 2 Status	2		1 = Active, 0 = Inactive
Alarm 3 Status		RO	1 = Active, 0 = Inactive
Alarm 1 Latched	4		1 = Alarm 1 Latched, 0 = Not Latched*
PV Under Range		RO	1 = PV Under-range, 0 = PV within range
PV Over Range	6	RO	1 = PV Over-range, 0 = PV within range
Sensor Break	7	RO	1 = Sensor Break Active, 0 = Sensor Break Inactive
Latched Alarm Reset		WO	Writing any value resets all latched alarm relays. <b>Note: Outputs will only reset if their alarm condition is no longer present.</b>
Reset Maximum PV		WO	Writing any value resets the stored maximum displayed PV value
Reset Minimum PV	10	WO	Writing any value resets the stored minimum displayed PV value
Reset Elapsed Time	11	WO	Writing any value resets the stored alarm 1 active time value
Alarm 5 Status	12	RO	1 = Active, 0 = Inactive
Alarm 5 Status	13		1 = Active, 0 = Inactive
Alarm 2 Latched	14	RO	1 = Alarm 2 Latched, 0 = Not Latched*
Alarm 3 Latched	15	RO	1 = Alarm 3 Latched, 0 = Not Latched*
Alarm 4 Latched	16	RO	1 = Alarm 4 Latched, 0 = Not Latched*
Alarm 5 Latched	17	RO	1 = Alarm 5 Latched, 0 = Not Latched*

To set the bit value to 1 write FF, to set the bit value to 0 write 00. Refer to Function Code 05 in the Modbus Communications section

**\*Note:**

*Alarm Latched status requests always returns 0 if that alarm is not configured to be latching.*

**Word Parameters**

Table 30. DI1700 Communications - Word Parameters

Parameter	Modbus Parameter No.		ASCII Ident & Message Types		Notes	
Process Variable	1	RO	<b>M</b> Type 2	RO	Current value of PV.	
					If under-range = 62976 (<??>5 ASCII)	
					If over-range = 63232 (<??>0 ASCII)	
					Sensor break = 63488 (ASCII = n/a)	
Process Variable Maximum	2	RO	<b>A</b> Type 2	RO	Maximum displayed value since this was last reset. Shows under/over-range or break values if appropriate.	
Process Variable Minimum	3	RO	<b>B</b> Type 2	RO	Minimum displayed value since this was last reset. Shows under/over-range or break values if appropriate.	
Alarm 1 Elapsed Time	4	RO	<b>T</b> Type 2	RO	Accumulated alarm 1 active time since this was last reset. Returns the over-range value if the time exceeds 1000 minutes. Units = seconds in Modbus	
Instrument Status	5	RO	<b>L</b> Type 2	RO	<b>Bit</b>	<b>Meaning</b>
					0	Alarm 1 status. 0 = activated, 1 = safe
					1	Alarm 2 status. 0 = activated, 1 = safe
					2	Alarm 3 status. 0 = activated, 1 = safe
					3	Change Indicator. 1 = A parameter other than instrument status or PV has changed since the last time the status word was read.
					4	This bit always = 1
					5	Alarm 1 latched status. 0 = latched 1 = not latched or non-latching output type
					6	This bit always = 0
7	This bit always = 0					
Process Variable Offset	6	R/W	<b>J</b> Type 2, 3/4	R/W	Modified PV = Actual PV + PV Offset. Limited by Scale Range Maximum and Scale Range Minimum.	
Alarm 1 Value	7	R/W	<b>C</b> Type 2, 3/4	R/W	Alarm 1 active at this level	
Alarm 2 Value	8	R/W	<b>E</b> Type 2, 3/4	R/W	Alarm 2 active at this level	
Alarm 3 Value	9	R/W	<b>N</b> Type 2, 3/4	R/W	Alarm 3 active at this level	

Parameter	Modbus		ASCII Ident & Message Types		Notes
	Parameter No.				
Alarm 1 Hysteresis	10	R/W	<b>D</b> Type 2, 3/4	R/W	0 to 100% of span
Alarm 2 Hysteresis	11	R/W	<b>F</b> Type 2, 3/4	R/W	0 to 100% of span
Alarm 3 Hysteresis	12	R/W	<b>O</b> Type 2, 3/4	R/W	0 to 100% of span
Input Filter Time Constant	13	R/W	<b>m</b> Type 2, 3/4	R/W	0 to 100 seconds
Decimal Point Position	14	R/W	<b>Q</b> Type 2 Type 3/4	RO R/W	0 = xxxx 1 = xxx.x 2 = xx.xx 3 = x.xxx Read only if not Linear Input.
Scale Range Lower Limit	15	R/W	<b>H</b> Type 2 Type 3/4	RO R/W	Lower limit of scaled input range
Scale Range Upper Limit	16	R/W	<b>G</b> Type 2 Type 3/4	RO R/W	Upper limit of scaled input range
Re-transmit Output Maximum	18	R/W	<b>[</b> Type 2, 3/4	R/W	Maximum scale value for retransmit output, 1999 to 9999. This parameter applies to the first re-transmit output fitted (see also Modbus parameters 2214, 2224 & 2234).
Re-transmit Output Minimum	17	R/W	<b>\</b> Type 2, 3/4	R/W	Minimum scale value for retransmit output, 1999 to 9999. This parameter applies to the first re-transmit output fitted (see also Modbus parameters 2215, 2225 & 2235).
Scan Table			<b>]</b> Type 2	R	Reads back main process values. Response is: L{N}25aaaaabbbbb ccccddeeeeeeA* where: aaaaa = Process Variable value bbbbbb = Stored Maximum PV value ccccc = Stored Minimum PV value dddddd = Stored Alarm 1 Elapsed Time eeeeee = Instrument Status (see above)
Instrument commands			<b>Z</b> Type 3/4	WO	Only Type 3 / 4 ASCII messages are allowed with this parameter. The {DATA} field must be one of four 5-digit numbers. The commands corresponding to the {DATA} field value are: 00150 = Unlatch Alarm 1 relay 00160 = Reset Stored Max PV 00170 = Reset Stored Min PV 00180 = Reset Alm1 Elapsed Time
Equipment ID	122	RO			The four digit model number 1F4A hex



Parameter	Modbus		ASCII Ident & Message Types		Notes	
	Parameter No.					
Serial Number Low	123	RO			Digits aaaa	Unit serial number. Format aaaa bbbb cccc, (12 BCD digits).
Serial Number Mid	124	RO			Digits bbbb	
Serial Number High	125	RO			Digits cccc	
Date of manufacture	126	RO			Manufacturing date code as an encoded binary number. E.g. 0403 for April 2003 is returned as 193hex	
Product Revision Level	129	RO			Low Byte	Alpha part of PRL. E.g. A = 01hex
					High Byte	Numeric part of PRL. E.g. 13 = 0Dhex
Firmware Version	130	RO			<b>Bits</b>	<b>Meaning</b>
					0 - 4	Revision number (1,2...)
					5 - 9	Alpha version (A=0, B=1...)
					10 - 15	Numeric version (starting from 121 = 0)
Input status	133	RO			Input status. Read Only. Bit 0: Sensor break flag Bit 1: Under-range flag Bit 2: Over-range flag	
Tare Enable	2111	R/W			0 = Disabled, 1 = Enabled	
Tare Activate	2112	RO			Write any value to activate.	
Option Slot 1 Re-transmit output Maximum	2214	R/W			Maximum scale value for retransmit output in slot 1, 1999 to 9999.	
Option Slot 1 Re-transmit output Minimum	2215	R/W			Minimum scale value for retransmit output in slot 1, 1999 to 9999.	
Option Slot 2 Re-transmit output Maximum	2224	R/W			Maximum scale value for retransmit output in slot 2, 1999 to 9999.	
Option Slot 2 Re-transmit output Minimum	2225	R/W			Minimum scale value for retransmit output in slot 2, 1999 to 9999.	
Option Slot 3 Re-transmit output Maximum	2234	R/W			Maximum scale value for retransmit output in slot 3, 1999 to 9999.	
Option Slot 3 Re-transmit output Minimum	2235	R/W			Minimum scale value for retransmit output in slot 3, 1999 to 9999.	

**Note:**

*Some of the parameters that do not apply to a particular configuration will accept reads and writes (e.g. attempting to scale a Linear output which has not been fitted). Read only parameters will return an exception if an attempt is made to write values to them.*

## 12 Manually Tuning Controllers

### Single Control Tuning (PID with Primary Output only)

This simple technique balances the need to reach setpoint quickly, with the wish to limit setpoint overshoot at start-up or during process changes. It determines values for the Primary Proportional Band ( $Pb\_P$ ), Integral Time Constant ( $ArSt$ ) and Derivative Time Constant ( $rAtE$ ) that allow the PID control algorithm to give acceptable results in most applications that use a single control device.

**CAUTION:**

**This technique is suitable only for processes that are not harmed by large fluctuations in the process variable.**

1. Check that the Setpoint Upper Limit ( $SPUL$ ) and Setpoint Lower Limit ( $SPLL$ ) are set to safe levels for your process. Adjust if required.
2. Set the Setpoint to the normal operating value for the process (or to a lower value if overshoots beyond this value might cause damage).
3. Select On-Off control (i.e. set  $Pb\_P = 0$ ).
4. Switch on the process. The process variable will oscillate about the setpoint. Record the Peak-to-Peak variation ( $P$ ) of the first cycle (i.e. the difference between the highest value of the first overshoot and the lowest value of the first undershoot), and the time period of the oscillation ( $T$ ) in minutes. See the example diagram below - Manually Tuning PID.
5. Calculate the PID control parameters using the formula below. Input Span is the difference between Scale Range Lower Limit and Scale Range Upper Limit:

$$Pb\_P = \frac{P}{\text{Input Span}} \times 100$$

$$ArSt = T \text{ minutes}$$

$$rAtE = \frac{T}{6} \text{ minutes}$$

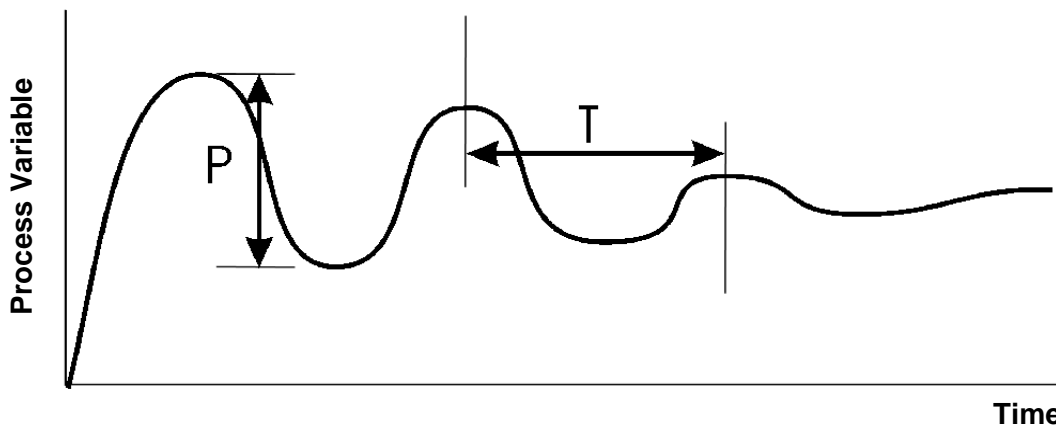

Figure 39. Manually Tuning PID

## Dual Control Tuning (PID with Primary and Secondary Outputs)

This simple tuning technique balances the need to reach setpoint quickly, with the wish to limit setpoint overshoot at start-up and during process changes. It determines values for the Primary Proportional Band ( $Pb\_P$ ), Secondary Proportional Band ( $Pb\_S$ ), Integral Time Constant ( $ArSt$ ) and Derivative Time Constant ( $rAtE$ ) that allow the PID control algorithm to give acceptable results in most applications that use dual control (e.g. Heat & Cool).

### CAUTION:

**This technique is suitable only for processes that are not harmed by large fluctuations in the process variable.**

1. Tune the controller using only the Primary Control output as described in the Single Control Tuning section above.
2. Set  $Pb\_S$  to the same value as  $Pb\_P$  and monitor the operation of the controller in dual control mode. If there is a tendency to oscillate as the control passes into the Secondary Proportional Band, increase the value of  $Pb\_S$ . If the process appears to be over-damped in the region of the Secondary Proportional Band, decrease the value of  $Pb\_S$ .
3. When the PID tuning values have been determined, if there is a kick to the process variable as control passes from one output to the other, set the Overlap/Deadband parameter to a positive value to introduce some overlap. Adjust this value by trial and error until satisfactory results are obtained.

## Valve Control Tuning (PI with VMD or Linear Outputs)

This tuning technique is used when controlling a modulating valves, either with a Valve Motor Drive Controller, or if a standard controller if the valve requires a linear (mA/VDC) signal for its positioning circuitry. It determines values for the Primary Proportional Band ( $Pb\_P$ ), and Integral Time Constant ( $ArSt$ ). The Derivative Time Constant ( $rAtE$ ) is normally set to zero (OFF). This PI Control minimises valve wear whilst giving optimal process control.

### CAUTION:

**This technique is suitable only for processes that are not harmed by large fluctuations in the process variable.**

1. Check that the Motor Travel Time ( $t_r$ ) matches the time taken for the valve to travel between its physical end stops. Adjust if required.
2. Check that the Minimum Motor On Time ( $t_{on}$ ) matches the minimum drive effort needed to initiate valve movement when stationary. Adjust if required.
3. Set the setpoint to the normal operating process value (or to a lower value if overshoot beyond this value is likely to cause damage).
4. Set the Primary Proportional Band to the minimum value (i.e. set  $Pb\_P = 0.5\%$ ).
5. Set the Integral Time Constant to the maximum value (i.e. set  $ArSt = 99.59$ ).
6. Set the Derivative Time Constant to OFF (i.e. set  $rAtE = 0.00$ ).

7. Using manual control ensure that the valve is positioned away from its end stops.
8. Follow the instructions in the diagram below. At each stage, allow sufficient settling time before moving on to the next stage.

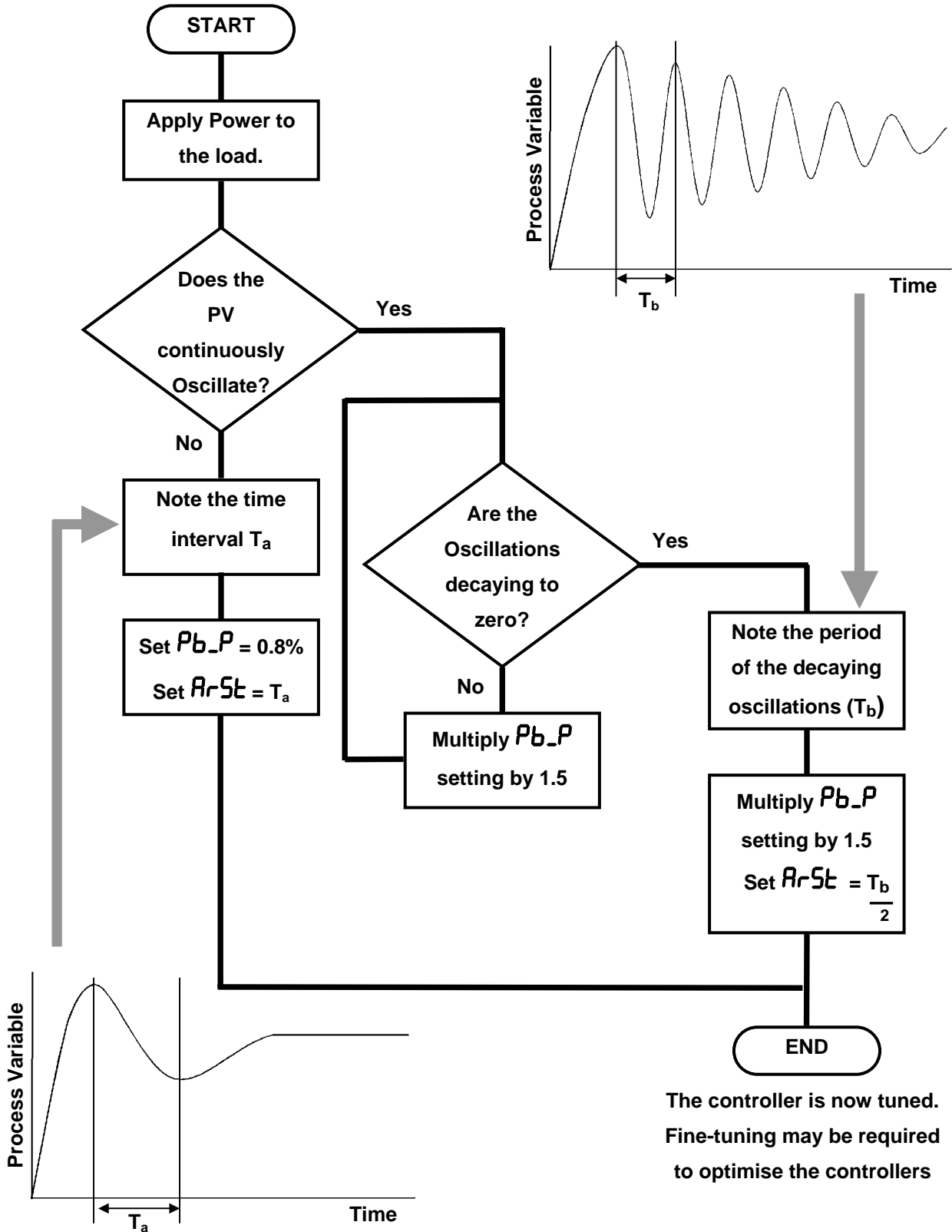

Table 31. Manually Tuning Valve Control

## Manually Fine Tuning.

A separate cycle time adjustment parameter is provided for each time proportioning control output.

**Note:**

*Adjusting the cycle time affects the controllers operation; a shorter cycle time gives more accurate control but electromechanical components such as relays have a reduced life span.*

1. Increase the width of the proportional band if the process overshoots or oscillates excessively.
2. Decrease the width of the proportional band if the process responds slowly or fails to reach setpoint.
3. Increase the automatic reset until the process becomes unstable, then decrease until stability has been restored.

**Note:**

*Allow enough time for the controller and process to adjust.*

4. Initially add rate at a value between  $1/4^{\text{th}}$  and  $1/10^{\text{th}}$  of the automatic reset value.
5. Decrease Rate if the process overshoots/undershoots or oscillates excessively.

**Note:**

*When controlling a modulating valve, it is recommended that Rate (Derivative) is set to 0 seconds (OFF) to avoid excessive valve activity.  
Rate can cause process instability.*

6. After making all other adjustments, if an offset exists between the setpoint and the process variable use the Bias (manual reset) to eliminate the error:  
Below setpoint - use a larger bias value  
Above setpoint - use a smaller bias value.

### 13 Modbus Serial Communications

All models support the Modbus RTU communication protocol. Some models also support an ASCII communication protocol. Where both Modbus and ASCII are supported, the protocol to be used is selected from Configuration Mode. The RS485 Communications Module must be fitted into Option Slot A in order to use serial communications.

Refer to the relevant Model Group Section for the ASCII and Modbus Application Layer (parameter address/ident information).

For a complete description of the Modbus protocol refer to the description provided at <http://www.modicon.com/> or <http://www.modbus.org/>

#### Physical Layer

The Base address, bit rate and character format are configured via the front panel in Configuration Mode or by using the PC Configurator software.

Physical layer configuration settings possible are:

Data rate: 1200, 2400, 4800 (default), 9600 and 19,200 bps

Parity: None (default), Even, Odd

Character format: Always 8 bits per character.

The transmitter must not start transmission until 3 character times have elapsed since reception of the last character in a message, and must release the transmission line within 3 character times of the last character in a message.

**Note:**

*Three character times = 1.5ms at 19200, 3ms at 9600, 6ms at 4800, 12ms at 2400 and 24ms at 1200 bps.*

### Link Layer

A Query (or command) is transmitted from the Modbus Master to the Modbus Slave. The slave instrument assembles the reply to the master. All of the instruments covered by this manual are slave devices, and cannot act as a Modbus Master.

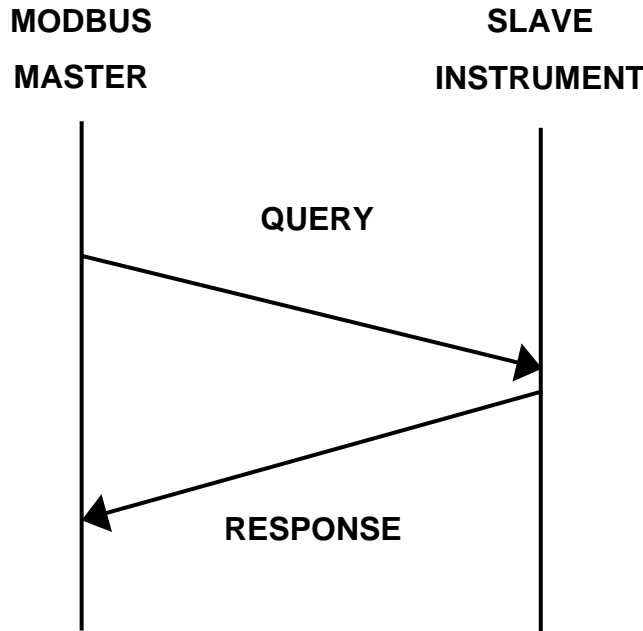

Figure 40. Modbus Link Layer

A message for either a QUERY or RESPONSE is made up of an inter-message gap followed by a sequence of data characters. The inter-message gap is at least 3.5 data character times.

Data is encoded for each character as binary data, transmitted LSB first.

For a QUERY the address field contains the address of the slave destination. The slave address is given together with the Function and Data fields by the Application layer. The CRC is generated from the given address, function and data characters.

For a RESPONSE the address field contains the address of the responding slave. The Function and Data fields are generated by the slave application. The CRC is generated from the address, function and data characters.

The standard MODBUS RTU CRC-16 calculation employing the polynomial  $2^{16}+2^{15}+2^2+1$  is used.

Inter-message gap	Address 1 character	Function 1 character	Data <i>n</i> characters	CRC Check 2 characters
-------------------	------------------------	-------------------------	-----------------------------	---------------------------

### Device Addressing

The instrument is assigned a unique device address by the user in the range 1 (default) to 255 using the **Addr** parameter in Configuration Mode. This address is used to recognise Modbus Queries intended for this instrument. The instrument does not respond to Modbus Queries that do not match the address that has been assigned to it.

The instrument will also accept global Queries using device address 0 no matter what device address is assigned. No responses are returned for globally addressed Queries.

### Supported Modbus Functions

Modbus defines several function types; these instruments support the following types:

Table 32. Supported Modbus Functions

Function Code (decimal)	Modbus Meaning	Description
01 / 02	Read Coil/Input Status	Read output/input status bits at given address.
03 / 04	Read Holding/Input registers	Read current binary value of specified number of parameters at given address. Up to 64 parameters can be accessed with one Query.
05	Force single Coil	Writes a single binary bit to the Specified Slave Bit address.
06	Pre-set Single Register	Writes two bytes to a specified word address.
08	Diagnostics	Used for loopback test.
16	Pre-set Multiple Registers	Writes up to 1 word parameter values to the specified address range.

### Function Descriptions

The following is interpreted from the Modbus Protocol Description obtainable from <http://www.modicon.com/> or <http://www.modbus.org/>. Refer to that document if clarification is required.

In the function descriptions below, the preceding device address value is assumed, as is the correctly formed two-byte CRC value at the end of the QUERY and RESPONSE frames.



### Read Coil/Input Status (Function 01 / 02)

Reads the content of instruments output/input status bits at the specified bit address.

Table 33. Read Coil/Input Status (Modbus Function 01/02)

QUERY				
Function	Address of 1st Bit		Number of Bits	
01 / 02	HI	LO	HI	LO

RESPONSE			
Function	Number of Bytes	First 8 bits	2nd 8 Bits
01 / 02			

In the response the “Number of Bytes” indicates the number of data bytes read from the instrument. E.g. if 16 bits of data are returned then the count will be 2. The maximum number of bits that can be read is 16 in one transaction. The first bit read is returned in the least significant bit of the first 8 bits returned.

### Read Holding/Input Registers (Function 03 / 04)

Reads current binary value of data at the specified word addresses.

Table 34. Read Holding/Input Registers (Modbus Function 03/04)

QUERY				
Function	Address of 1 <sup>st</sup> Word		Number of Words	
03 / 04	HI	LO	HI	LO

RESPONSE					
Function	Number of Bytes	First Word		Last Word	
03 / 04		HI	LO	HI	LO

In the response the “Number of Bytes” indicates the number of data bytes read from the instrument. E.g. if 5 words are read, the count will be 10 (A hex). The maximum number of words that can be read is 64. If a parameter does not exist at one of the addresses read, then a value of 0000h is returned for that word.

### Force Single Coil (Function 05)

Writes a single binary value to the Specified Instrument Bit address.

Table 35. Force Single Coil (Modbus Function 05)

#### QUERY

Function	Address of Bit		State to write	
05	HI	LO	FF/00	00

#### RESPONSE

Function	Address of Bit		State written	
05	HI	LO	FF/00	00

The address specifies the address of the bit to be written to. The State to write is FF when the bit is to be SET and 00 if the bit is to be RESET.

**Note:**

*The Response normally returns the same data as the Query.*

### Pre-Set Single Register (Function 06)

Writes two bytes to a specified word address.

Table 36. Pre-Set Single Register (Modbus Function 06)

#### QUERY

Function	Address of Word		Value to write	
06	HI	LO	HI	LO

#### RESPONSE

Function	Address of Word		Value written	
06	HI	LO	HI	LO

**Note:**

*The Response normally returns the same data as the Query.*

### Loopback Diagnostic Test (Function 08)

Table 37. Loopback Diagnostic Test (Modbus Function 08)

#### QUERY

Function	Diagnostic Code		Value	
08	HI =00	LO=00	HI	LO

#### RESPONSE

Function	Sub-function		Value	
08	HI=00	LO=00	HI	LO

**Note:**

*The Response normally returns the same data as the Query.*

### Pre-Set Multiple Registers (Function 10 Hex)

Writes a consecutive word (two-byte) value to the specified address range.

Table 38. Pre-Set Multiple Registers (Modbus Function 10 Hex)

**QUERY**

Function	1 <sup>st</sup> Word Address		Number of Words		Number of Query Bytes	First value to write	
10	HI	LO	HI	LO		HI	LO

**RESPONSE**

Function	1st Word Address		Number of Words	
10	HI	LO	HI	LO

**Note:**

*The number of consecutive words that can be written is limited to 1.*

### Exception Responses

When a QUERY is sent that the instrument cannot interpret then an Exception RESPONSE is returned. Possible exception responses are:

Table 39. Modbus Exception Responses

Exception Code	Error Condition	Interpretation
00	Unused	None.
01	Illegal function	Function number out of range.
02	Illegal Data Address	Write functions: Parameter number out of range or not supported. (for write functions only). Read Functions: Start parameter does not exist or end parameter greater than 65536.
03	Illegal Data Value	Attempt to write invalid data / required action not executed.

The format of an exception response is:

**RESPONSE**

Function	Exception Code
Original Function code with its Most Significant Bit (MSB) set.	<i>as detailed above</i>

**Note:**

*In the case of multiple exception codes for a single QUERY the Exception code returned is the one corresponding to the first parameter in error.*

### 14 ASCII Communications

This simple ASCII protocol provides backwards compatibility with some older products. ASCII is not available in all models in the range. The Modbus protocol is recommended for future use.

Refer to the relevant Model Group Section for the ASCII and Modbus Application Layer (parameter address/ident information).

#### Physical Layer

The Base address, bit rate and character format are configured via the front panel in Configuration Mode or by using the PC Configurator software.

Physical layer configuration settings possible are:

Data rate: 1200, 2400, 4800 (default), 9600 and 19,200 bps

Parity: Even

Character format: 7 bits per character. + 1 stop bit.

The transmitter must not start transmission until 3 character times have elapsed since reception of the last character in a message, and must release the transmission line within 3 character times of the last character in a message.

#### Note:

*Three character times = 1.5ms at 19200, 3ms at 9600, 6ms at 4800, 12ms at 2400 and 24ms at 1200 bps.*

#### Device Addressing

The instrument is assigned a device address by the user using the **Addr** parameter in Configuration Mode. The address may be set to any unique value from 1 (default) to 99. This address is used to recognise ASCII messages intended for this instrument. The instrument does not respond to messages that do not match the address that has been assigned to it.

#### Session Layer

The ASCII protocol assumes half duplex communications. The master device initiates all communication. The master sends a command or query to the addressed slave instrument and the slave replies with an acknowledgement of the command or the reply to the query.

Messages from the master device may be one of five types:

- Type 1: {S}{N}??\*
- Type 2: {S}{N}{P}{C}\* or R{N}{P}{C}\*
- Type 3: {S}{N}{P}#{DATA}\* or R{N}{P}#{DATA}\*
- Type 4: {S}{N}{P}I\* or R{N}{P}I\*
- Type 5: {S} {N} \ P S S ? \*

All characters are in ASCII code. See the following Parameter Key table for details of the parameters in brackets { }.

Table 40. ASCII Parameter Key

- {S}** is the Start of Message character L (Hex 4C)
- {N}** is the slave device address (in the range 1 - 99); addresses 1 - 9 may be represented by a single digit (e.g. 7) or in two-digit form, the first digit being zero (e.g. 07).
- {P}** is a character which identifies the parameter to be interrogated/modified.
- {C}** is the command (Refer to the Serial Communications Application Layer information for each Model Group)
- #** indicates that {DATA} is to follow (Hex 23)
- {DATA}** is a string of numerical data in ASCII code (refer to the Data Element table below)
- P** is the Program Number
- S S** is the Segment Number (01 to 16)
- \*** is the End of Message Character (Hex 2A)

No space characters are permitted in messages. Any syntax errors in a received message will cause the slave instrument to issue no reply and await the Start of Message character.

Table 41. ASCII Data Element – Sign/Decimal Point Position

{DATA} Content	Data Format	Description
abcd0	+abcd	Positive value, no decimal place
abcd1	+abc.d	Positive value, one decimal place
abcd2	+ab.cd	Positive value, two decimal places
abcd3	+a.bcd	Positive value, three decimal places
Abcd5	- abcd	Negative value, no decimal place
Abcd6	- abc.d	Negative value, one decimal place
Abcd7	- ab.cd	Negative value, two decimal places
Abcd8	- a.bcd	Negative value, three decimal places

(in the Data Content, abcd represents the data value, the last digit indicates data format)

### Type 1 Message

**L {N} ? ? \***

This message is used by the master device to determine whether the addressed slave device is active.

The reply from an active slave is

**L {N} ? A \***

An inactive device will give no reply.

### Type 2 Message

**L {N} {P} {C} \* or R {N} {P} {C} \***

This type of message is used by the master device, to interrogate or modify a parameter in the addressed slave device. **{P}** identifies the parameter and **{C}** represents the command to be executed, which may be one of the following:

- + (Hex 2B) = Increment the value of the parameter defined by **{P}**
- (Hex 2D) = Decrement the value of the parameter defined by **{P}**
- ? (Hex 3F) = Determine the current value of the parameter defined by **{P}**

The reply from the addressed slave device is of the form:

**L {N} {P} {DATA} A \* or R {N} {P} {DATA} A \***

where **{DATA}** comprises five ASCII-coded digits whose format is shown in the Data Element table above. The data is the value requested in a query message or the new value of the parameter after modification. If the action requested by the message from the master device would result in an invalid value for that parameter (either because the requested new value would be outside the permitted range for that parameter or because the parameter is not modifiable), the slave device replies with a negative acknowledgement:

**L {N} {P} {DATA} N \* or R {N} {P} {DATA} N \***

The **{DATA}** string in the negative acknowledgement reply will be indeterminate. If the process variable or the deviation is interrogated whilst the process variable is outside the range of the slave device, the reply is:

**L {N} {P} < ? ? > 0 A \***

if the process variable is over-range, or

**L {N} {P} < ? ? > 5 A \***

if the process variable is under-range.

### Type 3 Message

**L {N} {P} # {DATA} \* or R {N} {P} # {DATA} \***

This message type is used by the master device to set a parameter to the value specified in **{DATA}**. The command is not implemented immediately by the slave device; the slave will receive this command and will then wait for a Type 4 message (see below). Upon receipt of a Type 3 message, if the **{DATA}** content and the specified parameter are valid, the slave device reply is of the form:

**L {N} {P} {DATA} I \* or R {N} {P} {DATA} I \***

(where **I** = Hex 49) indicating that the slave device is ready to implement the command. If the parameter specified is invalid or is not modifiable or if the desired value is outside the permitted range for that parameter, the slave device replies with a negative acknowledgement in the form:

**L {N} {P} {DATA} N \* or R {N} {P} {DATA} N \***

## Type 4 Message

**L {N} {P} I \* or R {N} {P} I \***

This type of message is sent by the master device to the addressed slave device, following a successful Type 3 transaction with the same slave device. Provided that the **{DATA}** content and the parameter specified in the preceding Type 3 message are still valid, the slave device will then set the parameter to the desired value and will reply in the form:

**L {N} {P} {DATA} A \***

where **{DATA}** is the new value of the parameter. If the new value or parameter specified is invalid, the slave device will reply with a negative acknowledgement in the form:

**L {N} {P} {DATA} N \***

where **{DATA}** is indeterminate. If the immediately preceding message received by the slave device was not a Type 3 message, the Type 4 message is ignored.

## Error Response

The circumstances under which a message received from the master device is ignored are:

- Parity error detected
- Syntax error detected
- Timeout elapsed
- Receipt of a Type 4 message without a preceding Type 3 command message.

Negative acknowledgements will be returned if, in spite of the received message being notionally correct, the slave device cannot supply the requested information or perform the requested operation. The **{DATA}** element of a negative acknowledgement will be indeterminate.

## 15 Calibration Mode

### WARNING:

**CALIBRATION IS ONLY REQUIRED FOR INSTRUMENTS IN WHICH CALIBRATION ERRORS HAVE BEEN ENCOUNTERED. REFER TO CALIBRATION CHECK BELOW.**

### CAUTION:

**Calibration must be performed by personnel who are technically competent and authorised to do so.**

Calibration is carried out during manufacture and is not normally required again during the lifetime of an instrument.

### Equipment Required For Checking or Calibrating the Universal Input

A suitable calibration signal source is required for each input type. To verify the accuracy of the instrument or carry out recalibration, the listed input sources are required, with better than  $\pm 0.05\%$  of the reading accuracy:

1. DC linear inputs: 0 to 50mV, 0 to 10VDC and 0 to 20mADC.
2. Thermocouple inputs - complete with 0°C reference facility, appropriate thermocouple functions and compensating leads (or equivalent).
3. RTD inputs: decade resistance box with connections for three-wire input (or equivalent).

### Calibration Check

1. Set the instrument to the required input type.
2. Power up the instrument and connect the correct input leads.  
Leave powered up for at least five minutes for RTD and DC linear inputs, or at least 30 minutes for thermocouple inputs.
3. After the appropriate delay for stabilisation has elapsed, check the calibration by connecting the appropriate input source and checking a number of cardinal points.
4. Repeat the test for all required input types.



## Recalibration Procedure

Recalibration is carried out in five phases as shown in the table below, each phase corresponds to an input range of the instrument.

### CAUTION:

The 50mV phase **MUST** be calibrated before the thermocouple range.

Table 42. Input Calibration phases





<b>iP_1</b>	50 mV
<b>iP_2</b>	10 V
<b>iP_3</b>	20 mA
<b>iP_4</b>	RTD input (200 ohm)
<b>iP_5</b>	Thermocouple (K type source at 0°C required)

To start calibration, apply the required calibration input from the source type list above, using the correct connections,

1. Whilst the instrument is powering up, press  and  together until **iP\_1** is displayed.

### Note:

*If a phase has not been previously calibrated the display will flash.*

2. Press  to initiate calibration on PID Controllers, or  
Press  to initiate calibration on Limit Controllers, or  
Press  and  together to initiate calibration on Indicators.
3. During calibration the display changes to **----** for a few seconds.
4. If the input is misconnected or an incorrect signal is applied the calibration will be aborted and the display will show **FR iL**. The previous calibration value will be retained.
5. If the calibration has succeeded, the pass display is shown **iP\_1** (non-flashing).
6. Press  to step onto the next phase.
7. Repeat this process for each input type until all the phases are calibrated.

### Note:

*Switch off the instrument to exit the Calibration Mode.*

*Calibration Mode automatically exits if there is no button activity for five minutes.*

### 16 Appendix 1 – Glossary

This Glossary explains the technical terms and parameters used in this manual. The entry type is also shown:

<i>General Definition:</i>	Terms normally applicable all models.
<i>Controller Definition:</i>	Terms applicable to Controller models only.
<i>VMD Controller Definition:</i>	Terms applicable to VMD Controller models only.
<i>Limit Controller Definition:</i>	Terms applicable to Limit Controller models only.
<i>Indicator Definition:</i>	Terms applicable to Indicator models only.
<i>General Parameter:</i>	Parameters normally applicable all models.
<i>Controller Parameter:</i>	Parameters applicable to Controller models only.
<i>VMD Controller Parameter:</i>	Parameters applicable to VMD Controller models only.
<i>Limit Controller Parameter:</i>	Parameters applicable to Limit Controller models only.
<i>Indicator Parameter:</i>	Parameters applicable to Indicator models only.
<i>Controller Tuning Parameter:</i>	Parameters relating to the tuning of Controller models.

#### **Active Setpoint**

Type: *Controller Definition*

The Active Setpoint is the setpoint used as the current target Setpoint Value. Some controllers can have more than one setpoint (e.g. Setpoint 1 and 2 or Local and Remote Setpoints), but only one of these is active at any time.

*Also refer to Actual Setpoint, Remote Setpoint, Setpoint, Setpoint Select and Setpoint Select Enable.*

#### **Actual Setpoint**

Type: *Controller Definition*

Actual Setpoint is the current value of the setpoint. This may be different to the Active Setpoint's target value if the setpoint is currently ramping. The actual setpoint will rise or fall at the ramp-rate set, until it reaches the target setpoint value.

*Also refer to Active Setpoint, Setpoint, Setpoint Ramp Enable and Setpoint Select.*

### Alarm Hysteresis

Type: *General Parameter*

An adjustable band on the “safe” side of an alarm point, through which the process variable must pass before the alarm will change state, as shown in the diagram below. E.g. a high alarm’s hysteresis band is below the high alarm value, and a low alarm’s hysteresis is above the low alarm value.

Also refer to *Alarm Operation*.

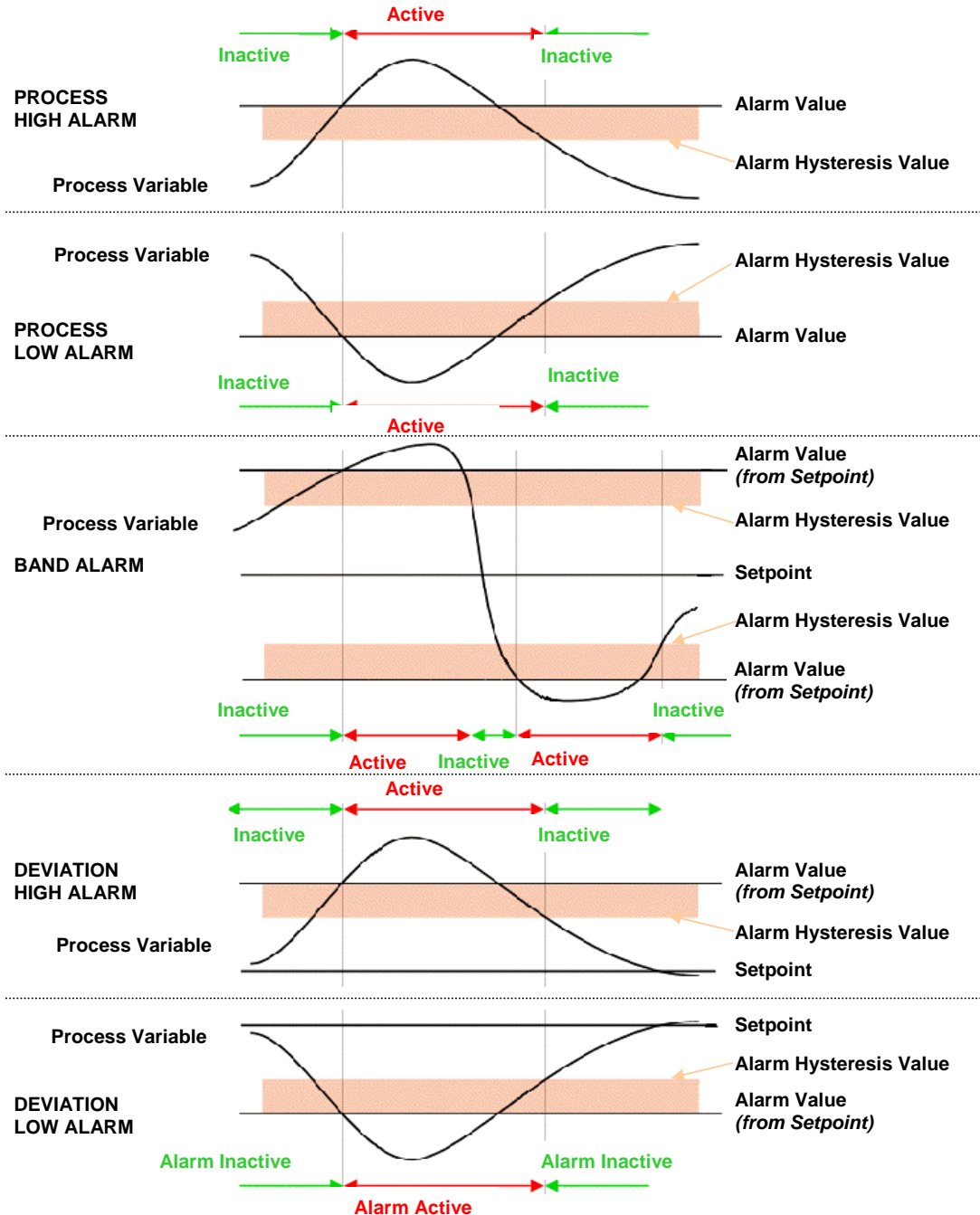

Figure 41. Alarm Hysteresis Operation

### Alarm Operation

Type: General Definition

The different alarm types are shown below, together with the action of any outputs. Also refer to *Alarm Hysteresis*, *Alarm Inhibit*, *Band Alarm*, *Deviation Alarm*, *Latching Relay*, *Logical Alarm Combinations*, *Loop Alarm*, *Process High Alarm* and *Process Low Alarm*.



Figure 42. Alarm Operation

**Alarm Inhibit**Type: *General Parameter*

Inhibits an alarm at power-up or when the controller Setpoint is switched, until that alarm goes inactive. The alarm operates normally from that point onwards.

*Also refer to Alarm Operation.*

**Annunciator**Type: *Limit Controller Definition*

A special type of alarm output that is linked to a Limit Controller's main Limit Output. An Annunciator output will activate when an Exceed condition occurs, and will remain active until a reset instruction is received, or the Exceed condition has passed. Unlike the Limit Output, an Annunciator can be reset even if the Exceed condition is present.

*Also refer to Exceed Condition, Latching Relay, Limit Controller, Limit Hysteresis and Limit Setpoint*

**Automatic Reset (Integral)**Type: *Controller Tuning Parameter*

Used to automatically bias the proportional output(s) to compensate for process load variations. It is adjustable in the range 1 seconds to 99 minutes 59 seconds per repeat and OFF (value greater than 99 minutes 59 seconds - display shows **OFF**). Decreasing the time increases the Integral action. This parameter is not available if the primary output is set to On-Off.

Display code = **ARSt**, default value = five minutes and zero seconds (**5.00**).

*Also refer to Primary Proportional Band, Secondary Proportional Band, Rate, PID, and Tuning.*

**Auto Pre-Tune**Type: *Controller Tuning Parameter*

Determines whether the Auto Pre-Tune feature is activated on power up (**d iSA** = disabled, **EnAb** = enabled). Auto Pre-Tune is useful when the process to be controlled varies significantly each time it is run. Auto Pre-Tune ensures that tuning occurs at the start of the process. Self-Tune may also be engaged to fine tune the controller.

Display code = **APt**, default setting = **d iSA**.

*Also refer to Pre-Tune, Self-Tune and Tuning.*

**Auxiliary Input**Type: *General Definition*

A secondary linear input option module. It can be used as a Remote Setpoint input or for Valve Position Indication. Signals can be mA, mV, VDC or Potentiometer.

*Also refer to Remote Setpoint, and Valve Position Indication.*

**Band Alarm 1 Value**Type: *General Parameter*

This parameter is applicable only if Alarm 1 is selected to be a Band Alarm. It defines a band of process variable values, centred on the current actual setpoint value. If the process variable value is outside this band, the alarm will be active. This parameter may be adjusted from 1 to full span from the setpoint.

Display code = **bAL 1**, default value = 5.

*Also refer to Alarm Operation, Band Alarm 2 Value and Input Span.*

**Band Alarm 2 Value**Type: *General Parameter*

This parameter, is similar to the Band Alarm 1 Value. It is applicable only if Alarm 2 is selected to be a Band Alarm.

Display code = **bAL 2**, default value = 5.

*Also refer to Alarm Operation, Band Alarm 1 Value and Input Span.*

### Bias (Manual Reset)

Type: *Controller Tuning Parameter*

Used to manually bias the proportional output(s) to compensate for process load variations. Bias is expressed as a percentage of output power and is adjustable in the range 0% to 100% (for Primary Output alone) or -100% to +100% (for both Primary and Secondary Outputs). This parameter is not applicable if the Primary output is set to ON/OFF control mode. If the process settles below setpoint use a higher Bias value to remove the error, if the process variable settles above the setpoint use a lower Bias value. Lower Bias values will also help to reduce overshoot at process start up.

Display code = **b RS**, default value = 25%.

Also refer to *ON/OFF Control and PID*.

### Bumpless Transfer

Type: *Controller Definition*

A method used prevent sudden changes to the output power level when switching between Automatic and Manual control modes. During a transition from Automatic to Manual, the initial Manual Power value will be set to equal the previous automatic mode value. The operator can then adjust the value as required. During a transition from Manual to Automatic, the initial Automatic Power value will be set to equal the previous manual mode value. The correct power level will gradually applied by the control algorithm at a rate dependant on the integral action resulting from the Automatic Reset time. Since integral action is essential to Bumpless Transfer, this feature is not available if Automatic Reset is turned off.

Also refer to *Automatic Rest and Manual Mode*

### Boundless VMD Control

Type: *VMD Controller Definition*

- Refer to *Open Loop VMD*.

### Cascade Control

Type: *Controller Definition*

Applications with two or more capacities (such as heated jackets) are inherently difficult for a single instrument to control, due to large overshoots and unacceptable lags. The solution is to cascade two or more controllers, each with its own input, in series forming a single regulating device. The product setpoint temperature is set on the master controller. This is compared to the product temperature, and the master's PID output (mA or VDC) is fed into a remote setpoint input on the slave. The RSP is scaled to suit any expected temperature. The slave loop's natural response time should ideally be at least 5 times faster than the master.

In the example, the maximum input represents 400°C, thus restricting the jacket temperature. At start-up the master compares the product temperature (ambient) to its setpoint (300°C) and gives maximum output. This sets the maximum (400°C) setpoint on the slave, which is compared to the jacket temperature (ambient) giving maximum heater output.

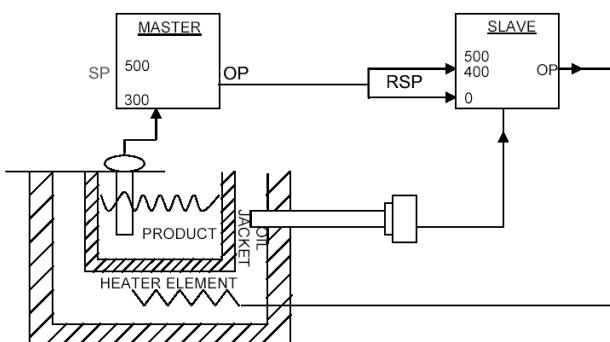

As the jacket temperature rises, the slave's heater output falls. The product temperature also rises at a rate dependant on the transfer lag between the jacket and product. This causes the master's PID output to decrease, reducing the 'jacket' setpoint on the slave, effectively reducing the output to the heater. This continues until the system becomes balanced.



When tuning a cascade system, first set the master to manual mode. Tune the slave controller using proportional control only (I & D are not normally required) then return the master to automatic mode before tuning the master. The result is quicker, smoother control with minimum overshoot and the ability to cope with load changes, whilst keeping the jacket temperature within acceptable tolerances.

*Also refer to Manual Mode, Master & Slave, PID, Remote Setpoint, Remote Setpoint Lower Limit, Remote Setpoint Upper Limit, Setpoint, Setpoint Select and Tuning.*

### Communications Write Enable

Type: General Definition

Enables/disables the changing of parameter values via the RS485 communications link, if the communications option is installed. Possible settings are read only or read/write.

Display code = **CoEn**, default setting = **r - W** (read/write).

### Control Type

Type: Controller Parameter

Defines if a controller has one or two control outputs. Single outputs can drive the PV in one direction only (e.g. heat only, cool only, increase humidity etc). Dual outputs can force the PV to increase or decrease (e.g. heat & cool, humidify and dehumidify etc).

Dual control is not possible on Valve Motor Drive controllers

Display codes = **SnGL** and **duAL**, default value = **SnGL**.

*Also refer to PID, Primary Proportional Band, Process Variable, Secondary Proportional Band and Valve Motor Control.*

### Controller

Type: Controller Definition

An instrument that can control a Process Variable, using either PID or On-Off control methods. Alarm outputs are also available that will activate at preset PV values, as are other options such as PV retransmission and Serial Communications.

*Also refer to Alarm Operation, Indicator, Limit Controller, On-Off Control, PID, Process Variable, Retransmit Output and Serial Communications.*

### CPU

Type: General Definition

This stands for Central Processing Unit and refers to the onboard microprocessor that controls all of the measuring, alarm and control functions of the instrument.

### Current Proportioning Control

Type: Controller Definition

Current proportioning control can be implemented on units configured with linear current or voltage output(s). It provides a 4 to 20mA, 0-20mA, 0 to 5V, 0 to 10V or 2 - 10V DC PID output. On-Off control should not be used with Current proportioning control.

*Also refer to On-Off Control, PID, Primary Proportional Band, Rate, Secondary Proportional Band and Time Proportional Control.*

### Cycle Time

Type: Controller Definition

For time proportioning outputs, it is used to define time period over which the average on vs. off time is equal to the required PID output level. **Ct 1**, **Ct 2** and **Ct 3** are available when option slots 1, 2 or 3 are defined as time proportioning output types. The permitted range of value is 0.5, 1, 2, 4, 8, 16, 32, 64, 128, 256 or 512 seconds. Shorter cycle times will give better control, but at the expense of reduce life when used with an electromechanical control device (e.g. relays or solenoid valves).

Display codes = **Ct 1**, **Ct 2** and **Ct 3**, default value = 32.

*Also refer to PID and Time Proportioning.*

**Deadband**Type: *Controller Parameter*- Refer to *Overlap/Deadband*.**Derivative**Type: *Controller Parameter*Refer to *Rate*.**Deviation Alarm 1 Value Type**Type: *General Parameter*

This is applicable only if Alarm 1 is selected to be Deviation Alarm. A positive value (Deviation High) sets the alarm point above the current actual setpoint, a negative value (Deviation Low) sets it below. If the process variable deviates from the setpoint by a margin greater than this value, alarm 1 becomes active.

Display code = **dAL1**, Default value = 5.*Also refer to Alarm Operation and Deviation Alarm 2 Value.***Deviation Alarm 2 Value**Type: *General Parameter*

Applicable only if Alarm 2 is selected as a Deviation Alarm. It is similar to Deviation Alarm 1 Value.

Display code = **dAL2**. Default value = 5.*Also refer to Alarm Operation and Deviation Alarm 1 Value.***Differential (On-Off Hysteresis)**Type: *Controller Parameter*

A switching differential used when one or both control outputs have been set to On-Off. This parameter is adjustable within the range 0.1% to 10.0% of input span; the default value is 0.5%. The differential band is centred about the setpoint.

Relay chatter can be eliminated by proper adjustment of this parameter. Too large a value for this parameter will increase amplitude of oscillation in this process variable.

Display code = **dIFP** for primary only differential, **dIFS** for secondary only differential & **dIFF** for primary and secondary differential.

*Also refer to Input Span and On-Off Control.***Direct/Reverse Action of Control Outputs**Type: *Controller Definition*

Direct action is typically used with cooling applications; On-Off direct outputs will turn on when the process variable exceeds setpoint. Proportional direct outputs will increase the percentage of output as the process value increases within the proportional band. Reverse action is typically used with heating applications; On-Off reverse outputs will turn off when the process variable exceeds setpoint. Proportional reverse outputs will decrease the percentage of output as the process value increases within the proportional band. The Secondary Output will be direct whenever the Primary Output is selected as reverse. The Secondary Output will be reverse whenever the Primary Output is selected as direct.

*Also refer to Control Type, On-Off Control, PID, Primary Proportional Band and Secondary Proportional Band***Display Strategy**Type: *General Parameter*

Alters the parameters displayed in normal operator mode. For example a controller could display PV + SP, PV + adjustable SP, PV + Ramping SP, PV only or SP only. Display strategy 6 will allow read only access to the setpoint values in Operator Mode, Setup Mode must then be entered to change the setpoint.

Display code = **dISP***Also refer to Process Variable, Setpoint and Setpoint Ramping.*



**Elapsed Time**Type: *Indicator Definition*

The total accumulated time that Alarm 1 has been active on an Indicator since this parameter was last reset. This does not include the time when the alarm condition has cleared. The Elapsed Time is not affected by the Alarm 2 and Alarm 3 status.

*Also refer to Alarm Operation, Exceed Time and Indicator.*

**Exceed Condition**Type: *Limit Controller Definition*

A state that occurs when the Process Variable exceeds the Limit Setpoint value. E.g. if the PV is above the Limit SP when set for high limit action, or below the Limit SP for low limit action. The Limit Controller will shut down the process when this condition occurs, and cannot be reset until the Exceed Condition has passed.

*Also refer to Annunciator, Exceed Time, Latching Relay, Limit Controller, Limit Hysteresis and Limit Setpoint.*

**Exceed Time**Type: *Limit Controller Definition*

The total accumulated time that a Limit Controller has been in the Exceed Condition since this parameter was last reset.

*Also refer to Elapsed Time, Exceed Condition and Limit Controller.*

**Indicator**Type: *Indicator Definition*

An instrument that can display a Process Variable. Alarm outputs are available that will activate at preset PV values. Relay outputs can be selected to have a Latching function similar to a Limit Controller output, but indicators do not have the necessary approvals for safety critical applications. Other options are PV retransmission and Serial Communications. Process control functions are not available.

*Also refer to Alarm Operation, Controller, Elapsed Time, Latching Relay, Limit Controller, Multi-Point Scaling, Process Variable, Retransmit Output, Serial Communications, Tare.*

**Input Filter Time Constant**Type: *General Parameter*

This parameter is used to filter out extraneous impulses on the process variable. The filtered PV is used for all PV-dependent functions (display control, alarm etc). The time constant is adjustable from 0.0 seconds (off) to 100.0 seconds in 0.5 second increments.

Display code = **F ILT**, Default value = 2.0 seconds.

*Also refer to Process Variable.*

**Input Range**Type: *General Definition*

This is the overall process variable input range and type as selected by the **INPT** parameter in Configuration Mode.

*Also refer to Input Span.*

**Input Span**Type: *General Definition*

The measuring limits, as defined by the Scale Range Lower and Scale Range Upper Limits. The trimmed span value is also used as the basis for calculations that relate to the span of the instrument (E.g. controller proportional bands)

*Also refer to Input Range, Scale Range Lower Limit and Scale Range Upper Limit.*

**Integral**Type: *Controller Tuning Parameter*

Refer to *Automatic Reset*.

**Latching Relay**Type: *General Definition*

A type of relay that, once it becomes active, requires a reset signal before it will deactivate. This output is available on Limit controllers and indicator alarms. To successfully deactivate a latched relay, the alarm or limit condition that caused the relay to become active must first be removed, then a reset signal can be applied. This signal may be applied from the instrument keypad, Digital Input or command via Serial Communication.

*Also refer to Alarm Operation, Indicator, Limit Controller, Limit Hysteresis, Serial Communications.*

**LED**Type: *General Definition*

Light Emitting Diode. LED's are used as indicator lights (e.g. for the alarm indication). The upper and lower 7-segment displays are also LED's.

**Limit Controller**Type: *Limit Controller Definition*

A protective device that will shut down a process at a preset Exceed Condition, in order to prevent possible damage to equipment or products. A fail-safe latching relay is used, which cannot be reset by the operator until the process is back in a safe condition. This signal may be applied from the instrument keypad, Digital Input or command via Serial Communication. Limit controllers work independently of the normal process controller. Limit Controllers have specific approvals for safety critical applications. They are recommended for any process that could potentially become hazardous under fault conditions.

*Also refer to Annunciator, Controller, Exceed Condition, Exceed Time, Latching Relay, Limit Hysteresis, Limit Setpoint and Serial Communications.*

**Limit Hysteresis**Type: *Limit Controller Definition*

An adjustable band on the "safe" side of the Limit Setpoint. For a high limit, the hysteresis band is below the limit setpoint value, for a low limit, the hysteresis is above the limit setpoint value. The latching limit relay cannot be reset by the operator until the process has passed through this band

*Also refer to Exceed Condition, Latching Relay, Limit Controller and Limit Setpoint.*

**Limit Setpoint**Type: *Limit Controller Definition*

The preset value at which an Exceed Condition will occur. When a Limit Controller has been set for High Limit control action, the Exceed Condition is above the Limit Setpoint. When a Limit Controller has been set for Low Limit control action, the Exceed Condition is below the Limit Setpoint.

*Also refer to Annunciator, Exceed Condition, Limit Hysteresis, Limit Controller and Setpoint.*

**Lock Codes**Type: *General Parameter*

Defines the four-digit codes required to enter Configuration (20), Set-Up (10), and Auto Tuning (0) modes.

Display codes = **cLoc**, **SLoc** and **tLoc**, default values shown above in brackets.

**Logical Combination of Alarms**

Type: *General Definition*

Two alarms may be combined logically to create an AND/OR situation. Any suitable output may be assigned as a Logical Alarm Output, configured for Reverse-acting or Direct action. *Also refer to Alarm Operation*

Table 43. Logical Alarm Outputs

Logical OR: Alarm 1 OR Alarm 2											
Direct Acting						Reverse-Acting					
ALARM 1	OFF	ALARM 2	OFF	OUTPUT	OFF	ALARM 1	OFF	ALARM 2	OFF	OUTPUT	ON
	ON		OFF		ON		OFF		OFF		
	OFF		ON		ON		ON		OFF		
	ON		ON		ON		ON		OFF		

Logical AND: Alarm 1 AND Alarm 2											
Direct Acting						Reverse-Acting					
ALARM 1	OFF	ALARM 2	OFF	OUTPUT	OFF	ALARM 1	OFF	ALARM 2	OFF	OUTPUT	ON
	ON		OFF		ON		OFF		ON		
	OFF		ON		OFF		ON		ON		
	ON		ON		ON		ON		OFF		

**Loop Alarm Enable**

Type: *Controller Parameter*

Enables or disables a loop alarm. A loop alarm is a special alarm, which detects faults in the control feedback loop, by continuously monitoring process variable response to the control output(s). The loop alarm can be tied to any suitable output. When enabled, the loop alarm repeatedly checks if the control output(s) are at the maximum or minimum limit. If an output is at the limit, an internal timer is started: thereafter, if the high output has not caused the process variable to be corrected by a predetermined amount 'V' after time 'T' has elapsed, the loop alarm becomes active. Subsequently, the loop alarm mode repeatedly checks the process variable and the control output(s). When the process variable starts to change value in the correct sense or when the output is no longer at the limit, the loop alarm is deactivated.

For PID control, the loop alarm time 'T' is always twice the Automatic Reset parameter value. For On-Off control, a user defined value for the Loop Alarm Time parameter is used.

The value of 'V' is dependent upon the input type. For Temperature inputs, V = 2°C or 3°F. For Linear inputs, V = 10 least significant display units

Control output limits are 0% for Single output (Primary only) controllers and -100% for Dual output (Primary and Secondary) controllers.

Correct operation of the loop alarm depends upon reasonably accurate PID tuning. The loop alarm is automatically disabled during manual control mode and during execution of the Pre-Tune mode. Upon exit from manual mode or after completion of the Pre-Tune routine, the loop alarm is automatically re-enabled.

Display code = **LAEn**, default value = **d 5A**,

*Also refer to Loop Alarm Time, Manual Mode, On-Off Control, Pre-Tune, and Process Variable.*

**Loop Alarm Time**Type: *Controller Parameter*

When On-Off control is selected and loop alarm is enabled, this parameter determines the duration of the limit condition after which the loop alarm will be activated. It may be adjusted within the range of 1 second to 99 minutes 59 seconds. This parameter is omitted from the Set-up mode display sequence if On-Off control is not selected or loop alarm is disabled.

Display code = **LAt**, Default setting is 99:59.

Also refer to *Loop Alarm Enable*.

**mADC**Type: *General Definition*

This stands for milliamp DC. It is used in reference to the DC milliamp input ranges and the linear DC milliamp outputs. Typically, these will be 0 to 20mA or 4 to 20mA.

**Manual Mode**Type: *Controller Definition*

If Manual Mode is enabled in Set-Up mode, pressing the **AM** key in operator mode will cause a controller to enter or leave manual control mode. Switching between automatic and manual modes is achieved using bumpless transfer.

For standard Process Controllers Manual Mode operates as follows:

The upper display shows the current process value, and the lower display shows the output power in the form - **Pxxx** (where xxx is equal to the percentage output power). This value may be adjusted using the **UP** or **DOWN** keys to increase/decrease the power output. The value can be varied between 0% to 100% for controllers using primary control only, and -100% to +100% for controllers using primary and secondary control (e.g. full heat power to full cool power).

For VMD Controllers with the Valve Position Indication feature Manual Mode operates as follows:

The upper display shows the current process value, and the lower display shows the output valve position in the form - **Pxxx** (where xxx is equal to the amount the valve is opened, between 0% and 100%). This value may be adjusted using the **UP** or **DOWN** keys to open or close the as required. The Open Valve output will be energised as long as the **UP** key is pressed, and the Close Valve output will be energised as long as the **DOWN** key is pressed.

For standard VMD Controllers without the Valve Position Indication feature Manual Mode operates as follows:

The upper display shows the current process value, and the lower display shows **PVA**. The valve may be adjusted using the **UP** or **DOWN** keys to open or close the as required. The Open Valve output will be energised as long as the **UP** key is pressed, and the Close Valve output will be energised as long as the **DOWN** key is pressed.

Manual Mode should be used with care because the power output level is set by the operator, therefore the PID algorithm is no longer in control of the process. The operator **MUST** maintain the process as the desired level manually. Manual power is not limited by the Primary Power Output Limit.

Also refer to *Bumpless Transfer, Manual Mode Enable, PID, and Primary Output Power Limit*.

**Manual Mode Enable**Type: *Controller Parameter*

Determines whether operator selection and de-selection of manual control is enabled. If the mode is enabled in Set-Up mode, pressing the **AM** key in Operator Mode will normally activate or deactivate manual control mode. However, disabling **PoEn** in whilst manual control mode is active will lock the controller into Manual Mode and pressing the Auto/Man key will no longer cause a return to PID (automatic) control. To exit from Manual Mode, **PoEn** must temporarily be re-enabled to allow PID control to be re-established. **PoEn** can then be safely disabled.

It is possible to use a controller as a permanent “Manual Station” by disabling **PoEn** to deliberately lock it into Manual Mode.

Manual Mode can also be selected using a digital input if one has been fitted and configured for this function. When in Manual Mode, the **MAN** LED indicator flashes.

Display code = **PoEn**, default setting = **d 5A** .

*Also refer to Manual Mode and PID*

**Master & Slave**Type: *Controller Definition*

The terms master & slave are used to describe the controllers in applications where one instrument controls the setpoint of another. The master controller can transmit the setpoint to the slave using an analogue DC linear signal. The slave controller must have a matching a remote setpoint input. Some Profile Controllers can transmit their setpoint via serial communications serial communications. For this method, the Profiler must be able to act as a communications master device and the slave must have a compatible communications option fitted.

*Also refer to Cascade Control, Retransmit Output, Remote Setpoint, Serial Communications, Setpoint*

**Minimum Motor On Time**Type: *VMD Controller Parameter*

This defines the minimum drive effort needed to initiate valve movement, if the valve was previously stationary. This parameter is used primarily to ensure that valve frictional and inertial effects do not cause controller drive to be ignored by the valve.

If Self-Tune is **OFF**, this parameter can be used to influence valve activity. Larger values reduce valve activity but increase the risk of the process oscillating. Self-Tune monitors on-control valve activity and will minimise it automatically.

Too large a value of Minimum Motor On Time can impair the effectiveness of the Self-Tune facility; if process variable oscillations persist whilst Self-Tune is running, it may be for this reason

Display code = **tr**, default setting = **1.00** .

*Also refer to Motor Travel Time, Self-Tune and Valve Motor Drive Control.*

**Modulating Valve**Type: *VMD Controller Definition*

A valve that can be positioned anywhere between fully closed and fully open by means of an incorporated motor. A typical application would be controlling temperature in a furnace heated by gas burners. A Valve Motor Drive (VMD) Controller is used to move the valve to the desired position in order to control the gas valve. Some modulating valve motors require linear (mA or VDC) signals to position the valve. These require standard Process Controllers (using PI control) instead of VMD types.

*Also refer to Motor Travel Time, PI Control and Valve Motor Drive Control.*

### Motor Travel Time

Type: *VMD Controller Parameter*

The Motor Travel Time parameter is the time the valve takes to travel from one physical end stop to the other. This parameter is used by the Valve Motor Drive control algorithm when calculating how long to energise the “Valve Open” or “Valve Close” outputs to bring the process on to control.

It is important that this time accurately reflects the time taken to travel between the *physical* limits otherwise control will be impaired. The motor travel time should be stated in the valve specification or can be obtained from the supplier or manufacturer. Failing that, the valve should be timed from the fully closed to fully opened position. The controller can be placed in Manual Mode to assist with the timing of valve movement.

Display code = **ton**, default setting = **1.00**.

Also refer to *Manual Mode Enable, Minimum Motor On Time and Valve Motor Drive Control*.

### Multi-Point Scaling Enable

Type: *Indicator Parameter*

When an Indicators Multi-Point Scaling function is enabled by setting **MP5** to **EnAb** in Configuration Mode, up to 9 breakpoints can be defined to linearize the input signal. This only applies to mA, mV or Voltage input types. For each breakpoint, an input scale value is entered, followed by the value to be shown at the breakpoint.

Display code = **MP5**, default setting = **d 5A** .

Also refer to *Indicator, Multipoint Scaling Set Up and Process Variable*.

### Multi-Point Scaling Set Up

Type: *Indicator Parameter*

For each breakpoint, the input scale value (**ScAn**) is entered as a percentage of the input span, followed by the value to be shown (**d Sn**) in display units, for this input value.

Each breakpoint's input scale value must be higher than the previous value, but the display values can be either higher or lower. This procedure is repeated for up to nine breakpoints, but if any scale value is set to 100% it automatically becomes the last in the series.

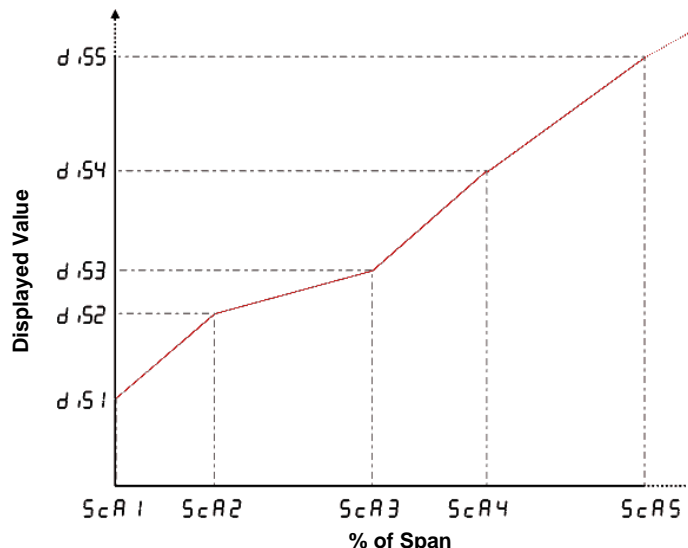

Also refer to *Indicator, Multipoint Scaling Enable and Process Variable*.



**Offset**Type: *Controller Parameter*

Offset is used to modify the measured process variable value and is adjustable in the range  $\pm$ input span. Use this parameter to compensate for errors in the displayed process variable. Positive values are added to the process variable reading, negative values are subtracted. This parameter is in effect, a calibration adjustment; it **MUST** be used with care. Injudicious use could lead to the displayed value bearing no meaningful relationship to the actual process variable. There is no front panel indication of when this parameter is in use.

Display value = **OFFS**, default value = 0.

*Also refer to Input Span, Process Variable and Tare.*

**On-Off Control**Type: *Controller Definition*

When operating in On-Off control, the output(s) will turn on or off as the process variable crosses the setpoint in a manner similar to a central heating thermostat. Some oscillation of the process variable is inevitable when using On-Off control.

On-Off control can be implemented only with Time Proportioning Control (Relay, Triac or SSR driver output), by setting the corresponding proportional band(s) to zero. On-Off operation can be assigned to the Primary output alone (secondary output not present), Primary and Secondary outputs or Secondary output only (with the primary Output set for time proportional or current proportional control).

On-Off control cannot be used on Valve Motor Drive controllers.

*Also refer to Differential, PID, Process Variable, Primary Proportional Band, Secondary Proportional Band, Setpoint, Time Proportioning Control and Valve Motor Drive Control.*

**On-Off Differential (Hysteresis)**Type: *Controller Parameter*

Refer to *Differential*.

**Open Loop VMD**Type: *VMD Controller Definition*

An "Open Loop" PID control algorithm does not require a position feedback signal from the valve in order to correctly control the process. Instead, the Process Variable's deviation from the Setpoint is used to decide how long the valve open or close outputs should be energised (in relation to the Motor Travel Time) in order to bring the process under control.

Even when position feedback is provided for Valve Position Indication, the controller does not use this signal when positioning the valve, so problems associated with faulty feedback signals are avoided.

*Also refer to Modulating Valve, Motor Travel Time, PID, Process Variable, Setpoint, Valve Position Indication and Valve Motor Drive Control.*

**Overlap/Deadband**Type: *Controller Parameter*

Defines the portion of the primary and secondary proportional bands ( $Pb\_P + Pb\_S$ ) over which both outputs are active (Overlap), or neither is active (Deadband). It is adjustable in the range -20% to +20% of the two proportional bands added together. Positive values = Overlap, negative values = Deadband.

This parameter is not applicable if the primary output is set for On-Off control or there is no Secondary Output. If the Secondary Output is set for On-Off, this parameter has the effect of moving the Differential band of the Secondary Output to create the overlap or deadband.

When Overlap/Deadband = 0, the "OFF" edge of the Secondary Output Differential band coincides with the point at which the Primary Output = 0%. ).

Display code = **OL**, default value = 0%.

*Also refer to Differential, On-Off Control, Primary Proportional Band and Secondary Proportional Band.*

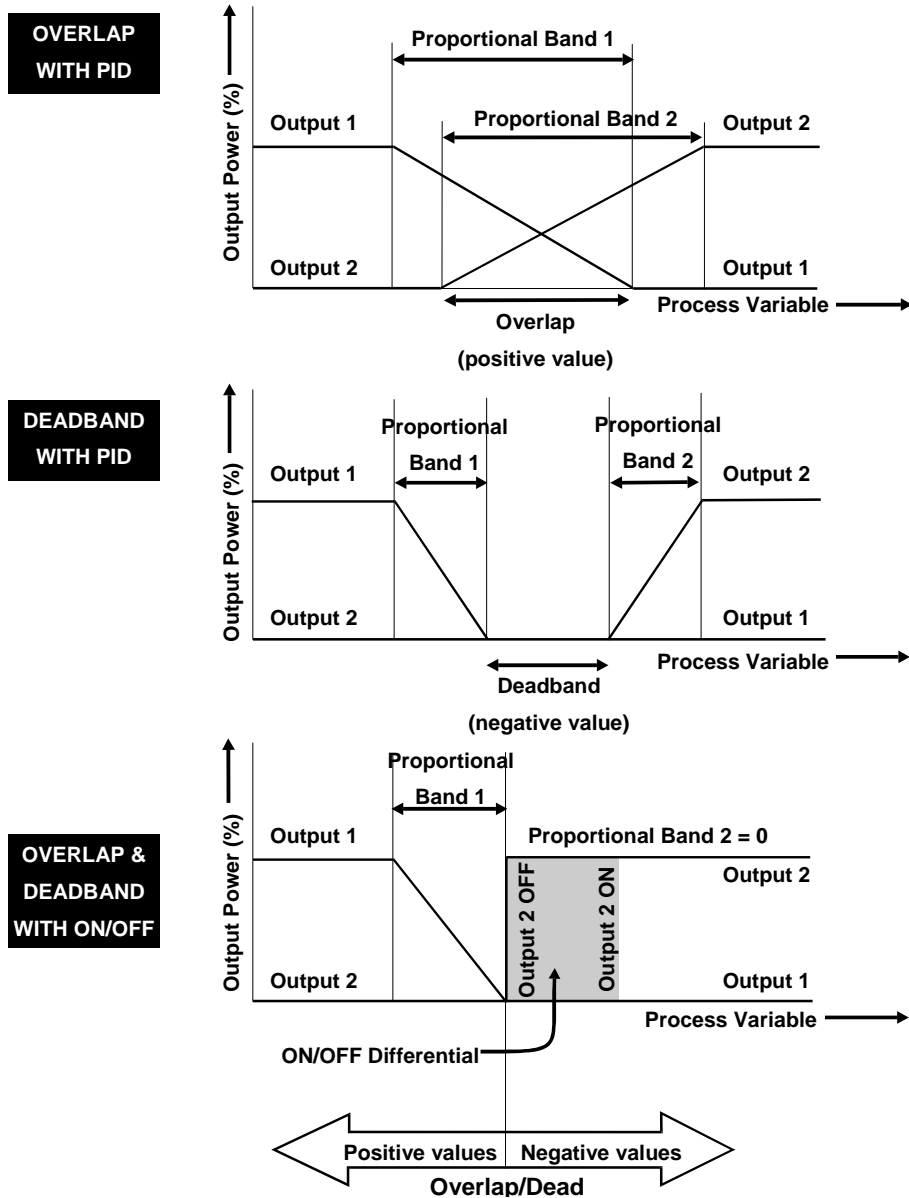

Figure 43. Overlap/Deadband

### PI Control

Type: *Controller Definition*

Proportional and Integral (PI) Control is used to control Modulating Valves. It is similar to PID Control, but without Derivative (Rate) action that causes excessive valve movement. Also refer to *Modulating Valve, PID Control, Rate, Tuning and Valve Motor Drive Control*.

### PID Control

Type: *Controller Definition*

Proportional Integral and Derivative control maintains accurate and stable levels in a process (e.g. temperature control). It avoids the oscillation characteristic of On-Off control by continuously adjusting the output to keep the process variable stable at the desired setpoint. Also refer to *Control Action, Control Type, Automatic Reset, Controller, Manual Mode, On-Off Control, PI Control, Primary Proportional Band, Process Variable, Rate, Secondary Proportional Band, Setpoint, Tuning and Valve Motor Drive Control*.



**PLC**

Type: *General Definition*

This stands for Programmable Logic Controller. A microprocessor based device used in machine control. It is particularly suited to sequential control applications, and uses “Ladder Logic” programming techniques. Some PLC’s are capable of basic PID control, but tend to be expensive and often give inferior levels of control.

*Also refer to PID.*

**Pre-Tune**

Type: *Controller Definition*

The Pre-Tune facility artificially disturbs the start-up pattern so that a first approximation of the PID values can be made prior to the setpoint being reached. During Pre-Tune, the controller outputs full Primary Power until the process value has moved approximately halfway to the setpoint. At that point, power is removed (or outputs full Secondary Power for Dual Control), thereby introducing an oscillation. Once the oscillation peak has passed, the Pre-Tune algorithm calculates an approximation of the optimum PID tuning terms proportional band(s), automatic reset and rate. The process is shown in the diagram below.

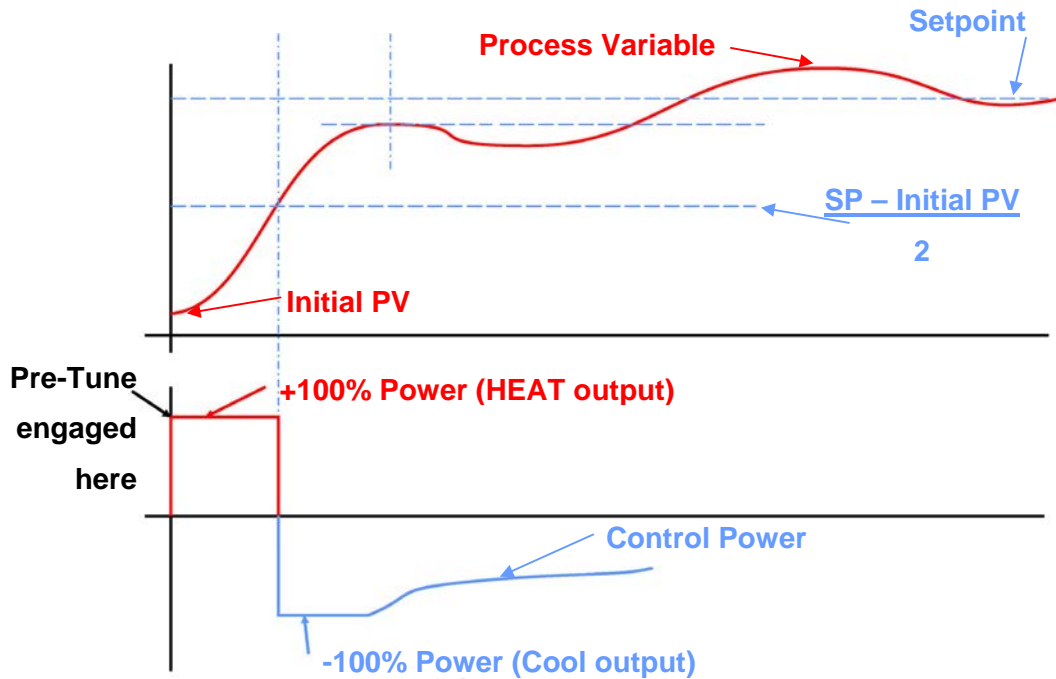

When Pre-Tune is completed, the PID control output power is applied using the calculated values. Pre-Tune limits the possibility of setpoint overshoot when the controller is new or the application has been changed. As a single-shot operation, it will automatically disengage once complete, but can be configured to run at every power up using the Auto Pre-Tune function.

The Pre-Tune feature on Valve Motor Drive controllers always sets the Rate parameter to zero (OFF) because derivative action is not usually desirable in these applications. Pre-Tune will not engage if either primary or secondary outputs on a controller are set for On-Off control, during setpoint ramping or if the process variable is less than 5% of the input span from the setpoint. Pre-Tune Operation

*Also refer to Auto Pre-Tune, Automatic Reset, Control Type, On-Off Control, Input Span, PID, Primary Proportional Band, Process Variable, Rate, Secondary Proportional Band, Self-Tune, Setpoint, Setpoint Ramping, Tuning and Valve Motor Drive Control.*

**Primary Output Power Limit**Type: *Controller Parameter*

Used to limit the power level of the Primary Output and may be used to protect the process being controlled. It may be adjusted between 0% and 100%. This parameter is not applicable if the primary output is set for On-Off control.

Display code is **OPh 1**, default value = 100%

*Also refer to On-Off Control.*

**Primary Proportional Band**Type: *Controller Tuning Parameter*

The portion of the input span over which the Primary Output power level is proportional to the process variable value. It may be adjusted in the range 0.0% (ON/OFF) to 999.9%.

Applicable if Control Type is Single or Dual. For dual control a Secondary Proportional band is used for the second output. The Control Action can be Direct or Reverse acting.

The Display value = **Pb\_P**, default value = 5.0%.

*Also refer to Control Action, Control Type, On-Off Control, Input Span, Overlap/Deadband, PID, Secondary Proportional Band, and Tuning.*

**Process High Alarm 1 Value**Type: *General Parameter*

This parameter, applicable only when Alarm 1 is selected to be a Process High alarm, defines the process variable value above which Alarm 1 will be active. Its value may be adjusted between Scale Range Upper Limit and Scale Range Lower Limit.

Display code = **PHA 1**, Default value = Scale Range Upper Limit.

*Also refer to Alarm Operation, Process High Alarm 2 Value, Process Variable, Scale Range Lower Limit and Scale Range Upper Limit.*

**Process High Alarm 2 Value**Type: *General Parameter*

This parameter, applicable only when Alarm 2 is selected to be a Process High alarm. It is similar to the Process High Alarm 1 Value.

Display code = **PHA2**, Default value = Scale Range Upper Limit.

*Also refer to Alarm Operation, Process High Alarm 1 Value, Process Variable, Scale Range Lower Limit and Scale Range Upper Limit.*

**Process Low Alarm 1 Value**Type: *General Parameter*

This parameter, applicable only when Alarm 1 is selected to be a Process low alarm, defines the process variable value below which Alarm 1 will be active. Its value may be adjusted between Scale Range Upper Limit and Scale Range Lower Limit.

Display code = **PLA 1**, Default value = Scale Range Lower Limit.

*Also refer to Alarm Operation, Process Low Alarm 2 Value, Process Variable, Scale Range Lower Limit and Scale Range Upper Limit.*

**Process Low Alarm 2 Value**Type: *General Parameter*

This parameter, applicable only when Alarm 2 is selected to be a Process low alarm. It is similar to the Process Low Alarm 1 Value.

Display code = **PLA2**, default value = Scale Range Lower Limit.

*Also refer to Alarm Operation, Process Low Alarm 1 Value, Process Variable, Scale Range Lower Limit and Scale Range Upper Limit.*

**Process Variable (PV)**Type: *General Definition*

Process Variable is the variable to be measured by the primary input of the instrument. The PV can be any parameter that can be converted into a electronic signal suitable for the input. Common types are Thermocouple or PT100 temperature probes, or pressure, level, flow etc from transducers which convert these parameters into linear DC signals (e.g. 4 to 20mA). Linear signals can be scaled into engineering units using the Scale Range Lower Limit and Scale Range Upper Limit parameters.

*Also refer to Input Span, Offset, Scale Range Lower Limit and Scale Range Upper Limit.*

**Process Variable Offset**Type: *General Parameter*

- Refer to *Offset*.

**Rate (Derivative)**Type: *Controller Tuning Parameter*

Rate is adjustable in the range 0 seconds (OFF) to 99 minutes 59 seconds. It defines how the control action responds to the rate of change in the process variable. This parameter should not be used in modulating value applications as it can cause premature wear due to constant small adjustments to the valve position. The Rate parameter is not available if primary control output is set to On-Off.

The Rate parameter is normally set to 0 seconds (OFF) on Valve Motor Drive controllers because derivative action is not usually desirable in these applications.

Display code = **rALE**, default value = 1.15.

*Also refer to On-Off Control, PID, Process Variable, Tuning and Valve Motor Drive Control.*

**Remote Setpoint (RSP)**Type: *Controller Definition*

Remote Setpoints use the Auxiliary Input option (a secondary analogue input) to adjust a controller's setpoint using an external linear DC Voltage or mA input signal, or in some cases potentiometer or mV inputs. The Remote Setpoint value is constrained by the Setpoint Upper Limit and Setpoint Lower Limit settings in the same way as a local setpoint. Typical applications are Master/Slave and Cascade Control.

Display code = **rSP**.

*Also refer to Auxiliary Input, Cascade Control, Remote Input Range, Remote Setpoint Lower Limit, Remote Setpoint Upper Limit, Setpoint and Setpoint Select.*

**Remote Auxiliary Input Range**Type: *Controller Parameter*

Defines the type and range of the linear input signal (mADC, mVDC, VDC or potentiometer) for the Auxiliary Input. mVDC and potentiometer are only available with the Full Auxiliary input module. This input can be used for Remote Setpoint or Valve Position Indication

Display code = **rIRP**, default value = **0\_10** for RSP inputs and **Pot** for Valve Position Indication.

*Also refer to Remote Setpoint, Setpoint and Valve Position Indication*

**Remote Setpoint Lower Limit**Type: *Controller Parameter*

Defines the value of the Remote Setpoint when the RSP input signal is at its minimum value (eg for a 4 to 20mA RSP, the value when 4mA is applied). It may be adjusted within the range -1999 to 9999; (decimal position same as for process variable input). However, the RSP value is always constrained within the Setpoint Upper Limit and Setpoint Lower Limits.

Display code = **rSPL**, default value = PV input range minimum.

*Also refer to Remote Setpoint, Remote Setpoint Input, Remote Setpoint Upper Limit, Remote Setpoint Offset, Setpoint and Setpoint Upper Limit and Setpoint Lower Limit.*

**Remote Setpoint Upper Limit**Type: *Controller Parameter*

Defines the value of the Remote Setpoint when the RSP input signal is at its maximum value (eg for a 4 to 20mA RSP, the value when 20mA is applied). It may be adjusted within the range -1999 to 9999; (decimal position same as for process variable input). However, the RSP value is always constrained within the Setpoint Upper Limit and Setpoint Lower Limits.

Display code = **rSPu**, default value = PV input range maximum.

*Also refer to Remote Setpoint, Remote Setpoint Input, Remote Setpoint Lower Limit, Remote Setpoint Offset, Setpoint and Setpoint Upper Limit and Setpoint Lower Limit.*

**Remote Setpoint Offset**Type: *Controller Parameter*

Used to adjust the Remote Setpoint input value. Positive values are added to the RSP reading, negative values are subtracted. It is adjustable in the range -1999 to 9999, but is constrained within the Scale Range Upper Limit and Scale Range Lower Limit.

Display value = **rSPo**, default value = 0.

*Also refer to Remote Setpoint, Scale Range Upper Limit and Scale Range Lower Limit.*

**Retransmit Output**Type: *General Definition*

A linear DC voltage or mA output signal, proportional to the Process Variable or Setpoint, for use by slave controllers or external devices, such as a Data Recorder or PLC. The output can be scaled to transmit any portion of the input or setpoint span.

*Also refer to Input Span, Master & Slave, Process Variable and Setpoint.*

**Retransmit Output 1 Scale Maximum**Type: *General Parameter*

Scales a linear output module in slot 1 that has been set up to retransmit PV or SP.

Retransmit Scale Maximum defines the value of the process variable, or setpoint, at which the output will be at its maximum value. E.g. for a 0 to 5V output, the value corresponds to 5V. It may be adjusted within the range -1999 to 9999; the decimal position is always the same as that for the process variable input. If this parameter is set to a value less than that for Retransmit Output 1 Scale Minimum, the relationship between the process variable/setpoint value and the retransmission output is reversed.

Display code = **roIH**, default value = Scale Range Upper Limit.

*Also refer to Process Variable, Retransmit Output, Retransmit Output 1 Scale Minimum, Scale Range Upper Limit and Setpoint.*

**Retransmit Output 1 Scale Minimum**Type: *General Parameter*

Scales a linear output module in slot 1 that has been set up to retransmit PV or SP.

Retransmit Scale Minimum defines the value of the process variable, or setpoint, at which the output will be at its minimum value. E.g. for a 0 to 5V output, the value corresponds to 0V. It may be adjusted within the range -1999 to 9999; the decimal position is always the same as that for the process variable input. If this parameter is set to a value greater than that for Retransmit Output Scale Maximum, the relationship between the process variable/setpoint value and the retransmission output is reversed.

Display code = **roIL**, default value = Scale Range Lower Limit.

*Also refer to Process Variable, Retransmit Output, Retransmit Output 1 Scale Maximum, Scale Range Lower Limit and Setpoint.*

**Retransmit Output 2 Scale Maximum**Type: *General Parameter*

Defines the value of the process variable, or setpoint, at which Retransmit Output 2 will be at its maximum value. It is similar to Retransmit Output 1 Scale Maximum.

Display code = **ro2H**, default value = Scale Range Upper Limit.

*Also refer to Process Variable, Retransmit Output, Retransmit Output 2 Scale Minimum, Scale Range Upper Limit and Setpoint.*

**Retransmit Output 2 Scale Minimum**Type: *General Parameter*

Defines the value of the process variable, or setpoint, at which Retransmit Output 2 will be at its minimum value. It is similar to Retransmit Output 1 Scale Minimum.

Display code = **ro2L**, default value = Scale Range Lower Limit.

*Also refer to Process Variable, Retransmit Output, Retransmit Output 2 Scale Maximum, Scale Range Lower Limit and Setpoint.*

**Retransmit Output 3 Scale Maximum**Type: *General Parameter*

Defines the value of the process variable, or setpoint, at which Retransmit Output 3 will be at its maximum value. It is similar to Retransmit Output 1 Scale Maximum.

Display code = **ro3H**, default value = Scale Range Upper Limit.

*Also refer to Process Variable, Retransmit Output, Retransmit Output 3 Scale Minimum, Scale Range Upper Limit and Setpoint.*

**Retransmit Output 3 Scale Minimum**Type: *General Parameter*

Defines the value of the process variable, or setpoint, at which Retransmit Output 3 will be at its minimum value. It is similar to Retransmit Output 1 Scale Minimum.

Display code = **ro3L**, default value = Scale Range Lower Limit.

*Also refer to Process Variable, Retransmit Output, Retransmit Output 3 Scale Maximum, Scale Range Lower Limit and Setpoint.*

**Reset**Type: *Controller Tuning Parameter*

-Refer to *Automatic Reset*.

**Reverse Acting**Type: *Controller Definition*

- Refer to *Direct/Reverse Action of Control Output*

**Scale Range Upper Limit**Type: *General Parameter*

For linear inputs, this parameter is used to scale the process variable into engineering units. It defines the displayed value when the process variable input is at its maximum value. It is adjustable from -1999 to 9999 and can be set to a value less than (but not within 100 units of) the Scale Range Lower Limit, in which case the sense of the input is reversed.

For thermocouple and RTD inputs, this parameter is used to reduce the effective range of the input. All span related functions work from the trimmed input span. The parameter can be adjusted within the limits of the range selected by Configuration Mode parameter **inPt**. It is adjustable to within 100 degrees of the Scale Range Lower Limit.

Display code = **rUL**, default value = 1000 for linear inputs or range maximum for temperature inputs.

*Also refer to Input Span, Process Variable and Scale Range Lower Limit.*



### Scale Range Lower Limit

Type: *General Parameter*

For linear inputs, this parameter can be used to display the process variable in engineering units. It defines the displayed value when the process variable input is at its minimum value. It is adjustable from -1999 to 9999 and can be set to a value more than (but not within 100 units of) the Scale Range Upper Limit, in which case the sense of the input is reversed. For thermocouple and RTD inputs, this parameter is used to reduce the effective range of the input. All span related functions, work from the trimmed span. The parameter can be adjusted within the limits of the range selected by Configuration Mode parameter *inPt*. It is adjustable to within 100 degrees of the Scale Range Upper Limit.

Display code = *rUL*, default value = 0 for linear inputs, or range minimum for temperature inputs.

Also refer to *Input Span, Process Variable and Scale Range Upper Limit*.

### Secondary Proportional Band

Type: *Controller Tuning Parameter*

The portion of the input span over which the Secondary Output power level is proportional to the process variable value. It may be adjusted in the range 0.0% (ON/OFF) to 999.9%. The Control action for the Secondary Output is always the opposite of the Primary output. The Secondary Proportional Band is only applicable when Dual Control Type is used.

Display value = *Pb\_S*, default value = 5.0%.

Also refer to *Control Action, Control Type, On-Off Control, Input Span, Overlap/Deadband, PID, Primary Proportional Band and Tuning*.

### Self-Tune

Type: *Controller Tuning Definition*

Self-Tune continuously optimises tuning while a controller is operating. It uses a pattern recognition algorithm, which monitors the process error (deviation). The diagram shows a typical application involving a process start up, setpoint change and load disturbance.

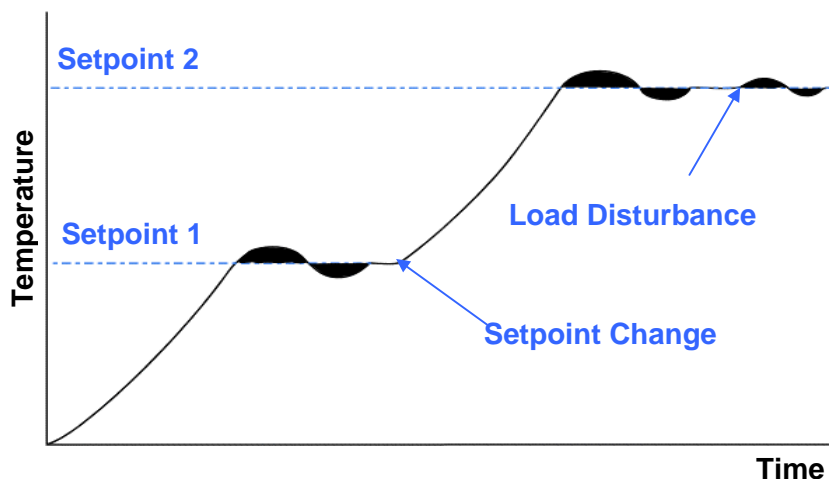

Figure 44. Self-Tune Operation

The deviation signal is shown shaded and overshoots have been exaggerated for clarity. The Self-Tune algorithm observes one complete deviation oscillation before calculating a set of PID values. Successive deviation oscillation causes values to be recalculated so that the controller rapidly converges on optimal control. When the controller is switched off, the final PID terms remain stored in the controller's non-volatile memory, and are used as starting values at the next switch on. The stored values may not always be valid, if for instance the controller is brand new or the application has been changed. In these cases the user can utilise Pre-Tune to establish new initial values.

Use of continuous self-tuning is not always appropriate for applications which are frequently subjected to artificial load disturbances, for example where an oven door is likely to be frequently left open for extended periods of time.

The Self-Tune feature on Valve Motor Drive controllers always sets the Rate parameter to zero (OFF) because derivative action is not usually desirable in these applications.

Self-Tune cannot be engaged if a controller is set for On-Off Control.

*Also refer to Minimum Motor On Time, On-Off Control, Pre-Tune, PID, and Tuning.*

### Serial Communications Option

Type: General Definition

An feature that allows other devices such as PC's, PLC's or a master controller to read or change an instruments parameters via an RS485 Serial link. Full details can be found in the Serial Communications sections of this manual.

*Also refer to Controller, Indicator, Master & Slave, Limit Controller and PLC*

### Set Valve Closed Position

Type: VMD Controller Parameter

When Valve Position Indication is to be used on Valve Motor Controllers, this parameter defines the input value that will be measured by the Auxiliary Input, when the valve is fully closed. The valve must driven to its "Closed" end stop before setting this parameter.

It must not be used to limit valve movement, separate Valve Close and Open Limit parameters are available for this purpose.

Display code = **PcUL**, default setting = Auxiliary Input Range Minimum.

*Also refer to Auxiliary Input, Set Valve Opened Position, Valve Close Limit, Valve Open Limit, Valve Motor Control and Valve Position Indication.*

### Set Valve Opened Position

Type: VMD Controller Parameter

When Valve Position Indication is to be used on Valve Motor Controllers, this parameter defines the input value that will be measured by the Auxiliary Input, when the valve is fully opened. The valve must driven to its "Open" end stop before setting this parameter.

It must not be used to limit valve movement, separate Valve Close and Open Limit parameters are available for this purpose.

Display code = **PcLL**, default setting = Auxiliary Input Range Maximum.

*Also refer to Auxiliary Input, Set Valve Closed Position, Valve Close Limit, Valve Open Limit, Valve Motor Control and Valve Position Indication.*

### Setpoint

Type: Controller Definition

The target value at which a controller will attempt to maintain the process variable by adjusting its power output level. Controllers can have either one or two setpoints. These can be one or two local internal setpoints (**SP** or **SP 1** and **SP 2**), or one local internal setpoint (**LSP**) and one externally adjusted remote (**rSP**) setpoint, if a Remote Setpoint module is fitted. The value of the setpoints can be adjusted between the Setpoint Upper Limit and Setpoint Lower Limits. The active setpoint is defined by the status of the Setpoint Select parameter or a digital input.

*Also refer to Limit Setpoint, Process Variable, Remote Setpoint, Scale Range Lower Limit, Setpoint Lower Limit, Setpoint Upper Limit and Setpoint Select*

**Setpoint Upper Limit**Type: *Controller Parameter*

The maximum limit allowed for operator setpoint adjustments. It should be set to keep the setpoint below a value that might cause damage to the process. The adjustment range is between Scale Range Upper Limit and Scale Range Lower Limit. The value cannot be moved below the current value of the setpoint.

Display code = **SPuL**, default value is Scale Range Upper Limit.

*Also refer to Scale Range Lower Limit, Scale Range Upper Limit, Setpoint and Setpoint Lower Limit.*

**Setpoint Lower Limit**Type: *Controller Parameter*

The minimum limit allowed for operator setpoint adjustments. It should be set to keep the setpoint above a value that might cause damage to the process. The adjustment range is between Scale Range Lower Limit and Scale Range Upper Limit. The value cannot be moved above the current value of the setpoint.

Display code = **SPLL**, default value = Scale Range Lower Limit.

*Also refer to Scale Range Lower Limit, Scale Range Upper Limit, Setpoint and Setpoint Upper Limit.*

**Setpoint Ramping Enable**Type: *Controller Parameter*

Enables or disables the viewing and adjustment of the Setpoint Ramp Rate in Operator Mode. This parameter does not disable the ramping SP feature; it merely removes it from Operator Mode. It can still be viewed and adjusted in Setup Mode. To turn off ramping, the ramp rate must be set to OFF (*blank*).

Display code = **SPr**, default setting = Disabled.

*Also refer to Process Variable, Setpoint and Setpoint Ramp Rate.*

**Setpoint Ramp Rate**Type: *Controller Parameter*

The rate at which the actual setpoint value will move towards its target value, when the setpoint value is adjusted or the active setpoint is changed. With ramping in use, the initial value of the actual setpoint at power up, or when switching back to automatic mode from manual control, will be equal to the current process variable value. The actual setpoint will rise/fall at the ramp rate set, until it reaches the target setpoint value. Setpoint ramping is used to protect the process from sudden changes in the setpoint, which would result in a rapid rise in the process variable.

Display code = **rP**, default setting = OFF (*blank*).

*Also refer to Manual Mode, Setpoint, Setpoint Ramp Enable and Setpoint Select.*



**Setpoint Select**Type: *Controller Parameter*

This Operator Mode parameter is available if the remote setpoint feature is in use and setpoint select is enabled, Setpoint Select defines whether the local or the remote setpoint will be the Active Setpoint. It can be set to **d i**, **LSP**, or **rSP**. If a digital input has been configured for local/remote setpoint selection, the default setting is **d i**. This means the status of the digital input will determine which setpoint is active. Otherwise the user can only choose **LSP**, or **rSP**. The active setpoint is indicated by prefixing its legend with the “**⌘**” character. E.g. the local setpoint legend is **⌘LSP**, when it is active and **LSP** when it is inactive. If a digital input has been configured to select local/remote SP, setting Setpoint Select to **LSP**, or **rSP** will override the digital input and the active SP indication changes to **⌘**.  
Display code = **SPS**.

*Also refer to Active Setpoint, Remote Setpoint, Setpoint and Setpoint Select Enable.*

**Setpoint Select Enable**Type: *Controller Parameter*

If the remote setpoint feature is in use, this determines whether operator selection of setpoints is enabled or disabled. If enabled, the Setpoint Select parameter is available in operator mode. If Setpoint Select is disabled again, the active setpoint will remain at its current status.

Display code = **SSEn**, default setting = **d iSA** (disabled).

*Also refer to Remote Setpoint and Setpoint.*

**Solid State Relay (SSR)**Type: *General Definition*

An external device manufactured using two Silicone Controlled Rectifiers, which can be used to replace mechanical relays in most AC power applications. As a solid state device, an SSR does not suffer from contact degradation when switching electrical current. Much faster switching cycle times are also possible, leading to superior control. The instrument's SSR Driver output is a time proportioned 10VDC pulse, which causes conduction of current to the load when the pulse is on.

*Also refer to Cycle Time, Time Proportioning Control, and Triac.*

**Solenoid Valve**Type: *General Definition*

An electromechanical device to control gas or liquid flow. It has just two states, open or closed. A spring holds the valve closed until a current is passed through the solenoid coil forces it open. Standard Process Controllers with Time Proportioned outputs are used to control solenoid valves.

Solenoid valves are often used with high/low flame gas burners. A bypass supplies some gas at all times, but not enough to heat the process more than a nominal amount (low flame). A controller output opens the solenoid valve when the process requires additional heat (high flame)..

*Also refer to Modulating Valves and Time Proportioning Control.*

**Tare**Type: *Indicator Parameter*

When an Indicator's Tare function has been enabled, the operator can set the current Process Variable input value to be displayed as zero. This function may be used to easily eliminate any offset on the input signal, e.g. when a transducer output is not giving a true zero value. It may also be used in applications displaying the weight of a product, to remove the weight of a container before starting. When Tare is activated, the instrument automatically sets the PV Offset to an equal, but opposite value to the current measured value.

Display code = **tArE**, default setting = **d,SA** (disabled).

*Also refer to Indicator, Process Variable, and Offset.*

**Three Point Stepping Control**Type: *VMD Controller Definition*

Refer to *Valve Motor Control*.

**Time Proportioning Control**Type: *Controller Definition*

Time proportioning control is accomplished by cycling the output on and off, during the prescribed cycle time, whenever the process variable is within the proportional band. The control algorithm determines the ratio of time (on vs. off) to achieve the level of output power required to correct any error between the process value and setpoint. E.g. for a 32 second cycle time, 25% power would result in the output turning on for 8 seconds, then off to 24 seconds. This type of output might be used with electrical contactors, Solid State Relays. Time proportioning control can be implemented with Relay, Triac or SSR Driver outputs for either primary (Heat) or secondary (Cool) outputs depending on hardware configuration. *Also refer to Current Proportioning Control, Cycle Time, PID, Primary Proportional Band, Process Variable, Secondary Proportional Band, Setpoint, SSR and Triac.*

**Tuning**Type: *Controller Definition*

PID Controllers must be tuned to the process in order for them to attain the optimum level of control. Adjustment is made to the tuning terms either manually, or by utilising the controller's automatic tuning facilities. Tuning is not required if the controller is configured for On-Off Control.

*Also refer to Automatic Reset, Auto Pre-Tune, On-Off control, PID, Pre-Tune, Primary Proportional Band, Rate, Self-Tune and Secondary Proportional Band.*

**Triac**Type: *General Definition*

A small internal solid state device, which can be used in place of a mechanical relay in applications switching low power AC, up to 1 amp. Like a relay, the output is time proportioned, but much faster switching cycle times are also possible, leading to superior control. As a solid-state device, a Triac does not suffer from contact degradation when switching electrical currents. A triac cannot be used to switch DC power.

*Also refer to Cycle Time, SSR and Time Proportioning Control.*

**Valve Close Limit**

Type: VMD Controller Parameter

When Valve Position Indication is to be used on Valve Motor Controllers, this parameter provides a “clamp” on the upper valve position, which the controller will not attempt to drive the valve past. It can be set between **0** (fully closed) and the Valve Open Limit value  $-1$ , expressed as a percentage of the valve’s “fully open” position.

The Auxiliary Input must correctly scaled using the Set Valve Open and Closed parameters before using this parameter.

Display code = **P** **UL**, default setting = **0**.

Also refer to *Auxiliary Input, Set Valve Closed Position, Set Valve Open Position, Valve Open Limit, Valve Motor Control and Valve Position Indication.*

**Valve Motor Drive Control**

Type: VMD Controller Definition

Valve Motor Drive Controllers are designed to control Modulating Valves using a special “Open Loop” Valve Motor Drive (VMD) PI control algorithm. Output signals are provided to move the valve further open, or further closed when the process is higher or lower than the desired setpoint. When on setpoint, no output is required to maintain control unless load conditions change. This known as Three-Point Stepping control.

Valve Position or Flow Indication is possible if an Auxiliary Input option module has been fitted and configured for this purpose.

Also refer to *Auxiliary Input, Modulating Valve, Open Loop VMD, PI Control, PID, Setpoint and Valve Position Indication.*

**Valve Position or Flow Indication**

Type: VMD Controller Definition

The Valve Motor Drive Controllers do not require any kind of position feedback in order for the PID algorithm to correctly control the process. However, where feedback or flow level signals are available, they can be displayed as a percentage (**0** to **100**) of the possible valve opening or flow level. Valve Position Indication is shown in the Operator Mode lower display in place of the Setpoint when the Display Strategy is set to **7**.

Valve Position Feedback is usually provided by means of a potentiometer linked to the valve. Potentiometers can be directly connected to the Full Auxiliary Input (Option Slot B only). Flow meters typically have linear 0-20/4-20mA or 0-5/0-10V signals, which can be used with either the Full Auxiliary Input or the Basic Auxiliary Input (Option Slot A only) of the 1/16 Din VMD Controllers.

Even when position feedback is provided in this way, the information is not used by the Open Loop VMD control algorithm when positioning the valve, avoiding problems associated with faulty feedback signals.

Also refer to *Auxiliary Input, Display Strategy, Open Loop VMD, PID, Set Valve Closed Position, Set Valve Open Position, Setpoint, and Valve Motor Control.*

**Valve Open Limit**

Type: VMD Controller Parameter

When Valve Position Indication is to be used on Valve Motor Controllers, this parameter provides a “clamp” on the upper valve position, which the controller will not attempt to drive the valve past. It can be set between **100** (fully open) and the Valve Closed Limit value  $+1$ , expressed as a percentage of the valve’s “fully open” position.

The Auxiliary Input must correctly scaled using the Set Valve Open and Closed parameters before using this parameter.

Display code = **P** **LL**, default setting = **100**.

Also refer to *Auxiliary Input, Set Valve Closed Position, Set Valve Open Position, Valve Close Limit, Valve Motor Control and Valve Position Indication.*

### **VMD**

- Refer to *Valve Motor Control*.

Type: *VMD Controller Parameter*

## 17 Appendix 2 - Specification

### Universal Input

#### General Input Specifications

<b>Input Sample Rate:</b>	Four samples/second.	
<b>Digital Input Filter time constant</b>	0.0 (OFF), 0.5 to 100.0 seconds in 0.5 second increments.	
<b>Input Resolution:</b>	14 bits approximately. Always four times better than display resolution.	
<b>Input Impedance:</b>	10V DC:	47KΩ
	20mA DC:	5Ω
	Other ranges:	Greater than 10MΩ resistive
<b>Isolation:</b>	Isolated from all outputs (except SSR driver). If single relay outputs are connected to a hazardous voltage source, and the universal input is connected to operator accessible circuits, supplementary insulation or input grounding is required.	
<b>PV Offset:</b>	Adjustable ±input span.	
<b>PV Display:</b>	Displays process variable up to 5% over and 5% under span.	

### Thermocouple

#### Thermocouple Ranges Available

Sensor Type	Range Min in °C	Range Max in °C	Range Min in °F	Range Max in °F	Resolution
J (default)	-200	1200	-328	2192	1°
J	-128.8	537.7	-199.9	999.9	0.1°
T	-240	400	-400	752	1°
T	-128.8	400.0	-199.9	752.0	0.1°
K	-240	1373	-400	2503	1°
K	-128.8	537.7	-199.9	999.9	0.1°
L	0	762	32	1403	1°
L	0.0	537.7	32.0	999.9	0.1°
N	0	1399	32	2551	1°
B	100	1824	211	3315	1°
R	0	1759	32	3198	1°
S	0	1762	32	3204	1°
C	0	2320	32	4208	1°
PtRh20%: PtRh40%	0	1850	32	3362	1°

**Note:**

*The Configuration Mode parameters, Scale Range Upper Limit and Scale Range Lower Limit, can be used to restrict range.*

### Thermocouple Performance

<b>Calibration:</b>	Complies with BS4937, NBS125 and IEC584.
<b>Measurement Accuracy:</b>	±0.1% of full range span ±1LSD. NOTE: Reduced performance for B Thermocouple from 100 to 600°C. NOTE: PtRh 20% vs PtRh 40% Thermocouple accuracy is 0.25% and has reduced performance below 800°C.
<b>Linearisation Accuracy:</b>	Better than ±0.2°C any point, for 0.1° resolution ranges (±0.05°C typical). Better than ±0.5°C any point, for 1° resolution ranges.
<b>Cold Junction Compensation:</b>	Better than ±0.7°C under reference conditions. Better than ±1°C under operating conditions.
<b>Temperature Stability:</b>	0.01% of span/°C change in ambient temperature.
<b>Supply Voltage Influence:</b>	Negligible.
<b>Relative Humidity Influence:</b>	Negligible.
<b>Sensor Resistance Influence:</b>	Thermocouple 100Ω: <0.1% of span error. Thermocouple 1000Ω: <0.5% of span error.
<b>Sensor Break Protection:</b>	Break detected within two seconds. Process Control outputs turn OFF (0% power); Valve Control "Close" outputs turn on; Limit outputs turn off (goes into Exceed condition); Alarms operate as if the process variable is over-range.

### Resistance Temperature Detector (RTD)

#### RTD Ranges Available

Range Min in °C	Range Max in °C	Range Min in °F	Range Max in °F	Resolution
-128.8	537.7	-199.9	999.9	0.1°
-199	800	-328	1472	1° (default)

**Note:**

*Scale Range Upper Limit and Scale Range Lower Limit Configuration Mode parameters can be used to restrict range.*

**RTD Performance**

<b>Type:</b>	Three-wire Pt100.
<b>Calibration:</b>	Complies with BS1904 and DIN43760 (0.00385Ω/Ω/°C).
<b>Measurement Accuracy:</b>	±0.1% of span ±1LSD.
<b>Linearisation Accuracy:</b>	Better than ±0.2°C any point, any 0.1°C range (±0.05°C typical). Better than ±0.5°C any point, any 1°C range.
<b>Temperature Stability:</b>	0.01% of span/°C change in ambient temperature.
<b>Supply Voltage Influence:</b>	Negligible.
<b>Relative Humidity Influence:</b>	Negligible.
<b>Sensor Resistance Influence:</b>	Pt100 50Ω/lead: <0.5% of span error.
<b>Lead Compensation:</b>	Automatic scheme.
<b>RTD Sensor Current:</b>	150µA (approximately).
<b>Sensor Break Protection:</b>	Break detected within two seconds. Process Control outputs turn OFF (0% power); Valve Control “Close” outputs turn on; Limit outputs turn off (goes into Exceed condition); Alarms operate as if the process variable has gone over-range.

**DC Linear**

**DC Linear Ranges Available**

0 to 20mA	0 to 50mV	0 to 5V
4 to 20mA (default)	10 to 50mV	1 to 5V
		0 to 10V
		2 to 10V

**DC Linear Performance**

<b>Scale Range Upper Limit:</b>	-1999 to 9999. Decimal point as required.
<b>Scale Range Lower Limit:</b>	-1999 to 9999. Decimal point as for Scale Range Upper Limit.
<b>Minimum Span:</b>	1 display LSD.
<b>Measurement Accuracy:</b>	±0.1% of span ±1LSD.
<b>Temperature stability:</b>	0.01% of span/°C change in ambient temperature.
<b>Supply Voltage Influence:</b>	Negligible.
<b>Relative Humidity Influence:</b>	Negligible.
<b>Input Protection:</b>	Up to 10 times maximum span of selected input connection.
<b>Sensor Break Protection:</b>	<b>Applicable for 4 to 20mA, 1 to 5V and 2 to 10V ranges only.</b> Process Control outputs turn OFF (0% power); Valve Control “Close” outputs turn on; Limit outputs turn off (goes into Exceed condition); Alarms operate as if process variable is under-range.



### Auxiliary Inputs

<b>Input Sampling rate:</b>	4 per second
<b>Input Resolution:</b>	13 bits minimum
<b>Input types:</b>	4 to 20mA, 0 to 20mA, 0 to 10V, 2 to 10V, 0 to 5V, 1 to 5V. The Full Auxiliary input in Option Slot B also supports 0 to 100mv and Potentiometer (2KΩ or higher).
<b>Measurement Accuracy (reference conditions):</b>	±0.25% of input span ±1 LSD
<b>Input resistance:</b>	Voltage ranges: 47KΩ nominal Current ranges: 5Ω
<b>Input protection:</b>	<b>Voltage input:</b> will withstand up to 5x input voltage overload without damage or degradation of performance in either polarity. <b>Current input:</b> will withstand 5x input current overload in reverse direction and up to 1A in the normal direction.
<b>Isolation:</b>	Slot A has basic isolation from other inputs and outputs. Slot B has reinforced isolation from other inputs and outputs.
<b>Sensor Break Detection:</b>	For 4 to 20mA, 2 to 10V and 1 to 5V ranges only.

### Digital Inputs

<b>Type:</b>	Voltage-free or TTL-compatible
<b>Voltage-Free Operation:</b> <i>functions depend on model and how configured</i>	Connection to contacts of external switch or relay: <b>Open</b> = SP1, Automatic Mode or Local setpoint selected. <i>Minimum contact resistance = 5KΩ,</i> <b>Closed</b> = SP2, Manual Mode, Remote Setpoint selected, Latching Relay, Stored Min/Max/Time reset (edge triggered) or Tare activate (edge triggered). <i>Maximum contact resistance = 50Ω.</i>
<b>TTL levels:</b> <i>functions depend on model and how configured</i>	<b>2.0 to 24VDC</b> = SP1, Automatic Mode, Local Setpoint selected. <b>-0.6 to 0.8VDC</b> = SP2, Manual Mode, Remote Setpoint selected, Latching Relay, Stored Min/Max/Time reset (edge triggered) or Tare activate (edge triggered).
<b>Maximum Input Delay (OFF-ON):</b>	0.25 second.
<b>Maximum Input Delay (ON-OFF):</b>	0.25 second.
<b>Isolation:</b>	Reinforced safety isolation from any source of hazardous voltages.

## Output Specifications

### Output Module Types

<b>Option Slot 1 Module Options:</b>	Relay, SSR drive, Triac or DC linear. <i>Limit Controllers have a fixed Latching Relay only.</i>
<b>Option Slot 2 Module Options:</b>	Relay, Dual Relay, SSR drive, Triac or DC linear. <i>Dual Relay option on some models only.</i>
<b>Option Slot 3 Module Options:</b>	Relay, Dual Relay, SSR drive, DC Linear or Transmitter PSU. <i>Dual Relay option on some models only.</i>

### Specifications of Output Types

<b>Single Relay:</b>	Contact Type:	Single pole double throw (SPDT).
	Control Rating:	2A resistive at 240V AC (120V when directly driving motorised valves). Limit Controller has a fixed 5A latching relay, in Option Slot 1.
	Alarm Rating:	2A resistive at 240V AC
	Control/Alarm Lifetime:	>500,000 operations at rated voltage/current.
	Limit Output Lifetime:	>100,000 operations at rated voltage/current.
	Isolation:	Basic Isolation from universal input and SSR outputs.
<b>Dual Relay:</b>	Contact Type:	2 x Single pole single throw (SPST) with shared common.
	Control Rating:	2A resistive at 240V AC (120V when directly driving motorised valves).
	Control/Alarm Lifetime:	>200,000 operations at rated voltage/current.
	Isolation:	Reinforced safety isolation from inputs and other outputs.
<b>SSR Driver:</b>	Drive Capability:	10V minimum at up to 20mA load.
	Isolation:	Not isolated from universal input or other SSR driver outputs.

<b>Triac:</b>	Operating Voltage Range:	20 to 280Vrms @47 to 63Hz. (140V max when directly driving motorised valves).
	Current Rating:	0.01 to 1A (full cycle rms on-state @ 25°C); derates linearly above 40°C to 0.5A @ 80°C.
	Max. Non-repetitive Surge Current (16.6ms):	25A peak.
	Min. OFF-State dv/dt @ Rated Voltage:	500V/μs.
	Max. OFF-State leakage @ Rated Voltage:	1mA rms.
	Max. ON-State Voltage Drop @ Rated Current:	1.5V peak.
	Repetitive Peak OFF-state Voltage, V <sub>drm</sub> :	600V minimum.
	Isolation:	Reinforced safety isolation from inputs and other outputs.
<b>Linear DC:</b>	Resolution:	Eight bits in 250mS (10 bits in 1 second typical, >10 bits in >1 second typical).
	Update Rate:	Every control algorithm execution.
	Ranges:	0 to 10V                      0 to 20mA 0 to 5V                        4 to 20mA 2 to 10V                       (default)
	Load Impedance:	0 to 20mA & 4 to 20mA: 500Ω maximum. 0 to 5V, 0 to 10V & 2 to 10V: 500Ω minimum. Short circuit protected.
	Accuracy:	±0.25% (mA @ 250Ω, V @ 2kΩ). Degrades linearly to ±0.5% for increasing burden (to specification limits).
	When used as control output:	For 4 to 20mA and 2 to 10V a 2% over/underdrive is applied (3.68 to 20.32mA and 1.84 to 10.16V).
	Isolation:	Reinforced safety isolation from inputs and other outputs.
	Use as 0 to 10VDC transmitter power supply* <i>Indicators only.</i>	Adjustable, 0.0 to 10.0V (regulated) output into 500Ω minimum.
<b>Transmitter Power Supply:</b> <i>*see Linear output spec for 0-10V PSU</i>	Power Rating	19 to 28VDC (24V nominal) into 910Ω minimum resistance.
	Isolation:	Reinforced safety isolation from inputs and other outputs.

## Control Specifications

<b>Automatic Tuning Types:</b>	Pre-Tune, Self-Tune.
<b>Proportional Bands:</b>	0 (ON/OFF control), 0.5% to 999.9% of input span at 0.1% increments. <i>ON/OFF control not valid for VMD controllers.</i>
<b>Automatic Reset (Integral Time Constant):</b>	1s to 99min 59s and OFF.
<b>Rate (Derivative Time Constant):</b>	0 (OFF) to 99 min 59 s.
<b>Manual Reset (Bias):</b>	Added each control algorithm execution. Adjustable in the range 0 to 100% of output power (single output) or -100% to +100% of output power (dual output). <i>Not valid for VMD controllers.</i>
<b>Deadband/Overlap:</b>	-20% to +20% of Proportional Band 1 + Proportional Band 2. <i>Not valid for VMD controllers</i>
<b>ON/OFF Differential:</b>	0.1% to 10.0% of input span.
<b>Motor Travel Time</b>	5 seconds to 5 minutes
<b>Minimum Motor On Time</b>	0.0 seconds to (Motor Travel Time/10)
<b>Auto/Manual Control:</b>	User-selectable with “bumpless” transfer into and out of Manual Control.
<b>Cycle Times:</b>	Selectable from 0.5s to 512 seconds in binary steps.
<b>Setpoint Range:</b>	Limited by Setpoint Upper Limit and Setpoint Lower Limit.
<b>Setpoint Maximum:</b>	Limited by Setpoint and Scale Range Upper Limit.
<b>Setpoint Minimum:</b>	Limited by Scale Range Lower Limit and Setpoint.
<b>Setpoint Ramp:</b>	Ramp rate selectable 1 to 9999 LSD's per hour and infinite. Number displayed is decimal-point-aligned with display.

## Process Alarms

<b>Maximum Number of Alarms (Controllers):</b>	Two “soft” process alarms (high, low, deviation or band) plus Loop Alarm.
<b>Maximum Number of Alarms (Indicators):</b>	Five “soft” alarms (process high or low)
<b>Combinatorial Alarms:</b>	Logical OR or AND of alarms to any suitable output.

## Digital Communications

<b>Type:</b>	Asynchronous Serial.
<b>Protocols Supported:</b>	Modbus RTU (all models) and ASCII (some models).
<b>Physical Layer:</b>	RS485.
<b>Zone address range:</b>	1 to 99 (ASCII), 1 to 255 (Modbus).
<b>Bit rate:</b>	1200, 2400, 4800, 9600 and 19200 bps.
<b>Bits per character:</b>	ASCII: 10 Modbus: 10 or 11 (depending on parity setting)
<b>Stop bits:</b>	1
<b>Parity:</b>	ASCII: Even (fixed). Modbus: None, even or odd (selectable).
<b>Isolation:</b>	Reinforced safety isolation from inputs and outputs.

### Reference Conditions

<b>Ambient Temperature:</b>	20°C ±2°C.
<b>Relative Humidity:</b>	60 to 70%.
<b>Supply Voltage:</b>	100 to 240V AC 50Hz ±1%.
<b>Source Resistance:</b>	<10Ω for thermocouple input.
<b>Lead Resistance:</b>	<0.1Ω/lead balanced (Pt100).

### Operating Conditions

<b>Ambient Temperature (operating):</b>	0°C to 55°C.
<b>Ambient Temperature (storage):</b>	-20°C to 80°C.
<b>Relative Humidity:</b>	20% to 95% non-condensing.
<b>Altitude:</b>	Up to 2000m above sea level.
<b>Supply Voltage:</b>	Either 100 to 240V ±10% AC 50/60Hz or 20 to 48V AC 50/60Hz & 22 to 55V DC
<b>Power Consumption:</b>	5W / 7.5 VA maximum.
<b>Source Resistance:</b>	1000Ω maximum (thermocouple).
<b>PT100 Input Lead Resistance:</b>	50Ω per lead maximum, balanced

### Standards

<b>Conformance Norms:</b>	CE, UL, ULC.
<b>EMC standards:</b>	EN61326*
<b>Safety Standards:</b>	EN61010 and UL3121. Pollution Degree 2, Installation Category II. Also FM 3545, 1998 for Limit Controllers.
<b>Front Panel Sealing:</b>	IP66

#### Note:

\*For disturbances induced by RF fields of 10V/m 80% AM at 1kHz the input accuracy specification is changed to 0.25% in the frequency bands 465 to 575 MHz and 630 to 660 MHz.

### Physical Specifications

<b>Dimensions:</b>	<b>Depth behind panel:</b>	110mm (1/16 DIN instruments). 100mm (1/8 DIN instruments).
	<b>Front bezel size (w x h):</b>	48 x 48mm (1/16 DIN instruments). 48 x 96mm (1/8 DIN controllers). 96 x 48mm (1/8 DIN indicators).
<b>Mounting:</b>		Plug-in with panel mounting fixing strap.
<b>Panel cut-out size (w x h)::</b>		45mm x 45mm (1/16 DIN instruments). 45 x 92mm (1/8 DIN controllers). 92 x 45mm (1/8 DIN indicators).
<b>Terminals:</b>		Screw type (combination head).
<b>Weight:</b>		0.21kg maximum.

### 18 Appendix 3 - Product Coding

Model Code	xxxxxx	-	x	-	x	-	x	-	x	-	x	-	x	-	x	-	x	-	x
<b>Model Type</b>																			
1/16 - DIN Controller	UDC120																		
1/8 - DIN Controller	UDC170																		
1/8 - DIN Indicator	UDI170																		
<b>Input Type</b>																			
3 Wire RTD or DC mV			1																
Thermocouple			2																
DC mA			3																
DC Voltage			4																
Limit Controller	(DC120)		L																
Universal Input + Full RSP	(DC170)		R																
VMD Controller (TPSC)	(DC120/DC170)		T																
<b>Option Slot 1</b>																			
Not fitted			0																
Relay Output			1																
DC Drive Output for SSR	(Not DC120L)		2																
Linear 0-10V DC Output	(Not DC120L)		3																
Linear 0-20mA DC Output	(Not DC120L)		4																
Linear 0-5V DC Output	(Not DC120L)		5																
Linear 2-10V DC Output	(Not DC120L)		6																
Linear 4-20mA DC Output	(Not DC120L)		7																
Triac Output	(Not DC120L)		8																
<b>Option Slot 2</b>																			
Not fitted			0																
Relay Output			1																
DC Drive Output for SSR			2																
Linear 0-10V DC Output			3																
Linear 0-20mA DC Output			4																
Linear 0-5V DC Output			5																
Linear 2-10V DC Output			6																
Linear 4-20mA DC Output			7																
Triac Output			8																
Dual Relay Output	(DI1700/DC170T)		9																

Continued on next page

Model Code	xxxxxx	-	x	-	x	-	x	-	x	-	x	-	x	-	x	-	x
<b>Option Slot 3</b>																	
Not fitted	0																
Relay Output	1																
DC Drive Output for SSR	2																
Linear 0-10V DC Output	3																
Linear 0-20mA DC Output	4																
Linear 0-5V DC Output	5																
Linear 2-10V DC Output	6																
Linear 4-20mA DC Output	7																
Transmitter Power Supply	8																
Dual Relay Output	9																
		(DI1700/DC170T/DC120T)															
<b>Option Slot A</b>																	
Not fitted	0																
RS-485 Serial Communications	1																
Digital Input 1	2																
Basic Auxiliary Input	4																
		(Not DC120L/DI1700)															
<b>Supply Voltage</b>																	
100-240V AC	0																
24-48V AV or DC	2																
<b>Display Colour</b>																	
Red LED Display	0																
Green LED Display	1																
Red/Green LED Colour Change Display	4																
		(DI1700)															
<b>Manual Language</b>																	
No Manual	0																
English	1																
French	2																
German	3																
Italian	4																
Spanish	5																
English/French/German/Italian/Spanish - Concise Manuals	9																
<b>Packing Options</b>																	
Single Pack with Concise Manual	0																
Bulk Pack with 1 Concise Manual per unit - (Minimum 20 pieces)	1																
Bulk Pack No Manual - (Minimum 20 pieces)	2																
Bulk Pack with 1 Full Manual per unit - (Minimum 20 pieces)	3																
Single Pack with 1 Full Manual per unit	5																



**Honeywell contacts**

**ARGENTINA**

HONEYWELL S.A.I.C.  
BELGRANO 1156  
BUENOS AIRES  
ARGENTINA  
Tel. : 54 1 383 9290

**ASIA PACIFIC**

HONEYWELL ASIA  
PACIFIC Inc.  
Room 3213-3225  
Sun Kung Kai Centre  
N° 30 Harbour Road  
WANCHAI  
HONG KONG  
Tel. : 852 829 82 98

**AUSTRALIA**

HONEYWELL LIMITED  
5 Thomas Holt Drive  
North Ryde Sydney  
NSW AUSTRALIA 2113  
Tel. : 61 2 353 7000  
AUSTRIA

**HONEYWELL AUSTRIA**

G.m.b.H.  
Handelskai 388  
A1020 VIENNA  
AUSTRIA  
Tel. : 43 1 727 800

**BELGIUM**

HONEYWELL S.A.  
3 Avenue de Bourget  
B-1140 BRUSSELS  
BELGIUM  
Tel. : 32 2 728 27 11

**BRAZIL**

HONEYWELL DO  
BRAZIL  
AND CIA  
Rua Jose Alves Da  
Chunha  
Lima 172  
BUTANTA  
05360.050 SAO PAULO  
SP  
BRAZIL  
Tel. : 55 11 819 3755

**BULGARIA**

HONEYWELL EOOD  
14, Iskarsko Chausse  
POB 79  
BG- 1592 Sofia  
BULGARIA  
Tel : 359-791512/  
794027/ 792198

**CANADA**

HONEYWELL LIMITED  
THE HONEYWELL  
CENTRE  
300 Yorkland Blvd.  
NORTH YORK,  
ONTARIO  
M2J 1S1  
CANADA  
Tel.: 800 461 0013  
Fax.: 416 502 5001

**CZECH**

REPUBLIC  
HONEYWELL, Spol.s.r.o.  
Budejovicka 1  
140 21 Prague 4  
Czech Republic  
Tel. : 42 2 6112 3434

**DENMARK**

HONEYWELL A/S  
Automatikvej 1  
DK 2860 Soeborg  
DENMARK  
Tel. : 45 39 55 56 58

**FINLAND**

HONEYWELL OY  
Ruukintie 8  
FIN-02320 ESPOO 32  
FINLAND  
Tel. : 358 0 3480101

**FRANCE**

HONEYWELL S.A.  
Bâtiment « le Mercury »  
Parc Technologique de St  
Aubin  
Route de l'Orme  
(CD 128)  
91190 SAINT-AUBIN  
FRANCE  
Tel. from France:  
01 60 19 80 00  
From other countries:  
33 1 60 19 80 00

**GERMANY**

HONEYWELL AG  
Kaiserleistrasse 39  
D-63067 OFFENBACH  
GERMANY  
Tel. : 49 69 80 64444

**HUNGARY**

HONEYWELL Kft  
Gogol u 13  
H-1133 BUDAPEST  
HUNGARY  
Tel. : 36 1 451 43 00

**ICELAND**

HONEYWELL  
Hataekni .hf  
Armuli 26  
PO Box 8336  
128 reykjavik  
Iceland  
Tel : 354 588 5000

**ITALY**

HONEYWELL S.p.A.  
Via P. Gobetti, 2/b  
20063 Cernusco Sul  
Naviglio  
ITALY  
Tel. : 39 02 92146 1

**MEXICO**

HONEYWELL S.A. DE  
CV  
AV. CONSTITUYENTES  
900  
COL. LOMAS ALTAS  
11950 MEXICO CITY  
MEXICO  
Tel : 52 5 259 1966

**THE NETHERLANDS**

HONEYWELL BV  
Laaderhoogtweg 18  
1101 EA AMSTERDAM  
ZO  
THE NETHERLANDS  
Tel : 31 20 56 56 911

**NORWAY**

HONEYWELL A/S  
Askerveien 61  
PO Box 263  
N-1371 ASKER  
NORWAY  
Tel. : 47 66 76 20 00

**POLAND**

HONEYWELL Sp.z.o.o  
Ul Domainewksa 41  
02-672 WARSAW  
POLAND  
Tel. : 48 22 606 09 00

**PORTUGAL**

HONEYWELL  
PORTUGAL LDA  
Edificio Suecia II  
Av. do Forte nr 3 - Piso 3  
2795 CARNAXIDE  
PORTUGAL  
Tel. : 351 1 424 50 00

**REPUBLIC OF IRELAND**

HONEYWELL  
Unit 1  
Robinhood Business  
Park  
Robinhood Road  
DUBLIN 22  
Republic of Ireland  
Tel. : 353 1 4565944

**REPUBLIC OF SINGAPORE**

HONEYWELL PTE LTD  
BLOCK 750E CHAI  
CHEE ROAD  
06-01 CHAI CHEE IND.  
PARK  
1646 SINGAPORE  
REP. OF SINGAPORE  
Tel. : 65 2490 100

**REPUBLIC OF SOUTH AFRICA**

HONEYWELL  
Southern Africa  
PO BOX 138  
Milnerton 7435  
REPUBLIC OF SOUTH  
AFRICA  
Tel. : 27 11 805 12 01

**ROMANIA**

HONEYWELL Office  
Bucharest  
147 Aurel Vlaicu Str.,  
Sc.Z.,  
Apt 61/62  
R-72921 Bucharest  
ROMANIA  
Tel : 40-1 211 00 76/  
211 79

**RUSSIA**

HONEYWELL INC  
4 th Floor Administrative  
Builiding of AO "Luzhniki"  
Management  
24 Luzhniki  
119048 Moscow  
RUSSIA  
Tel : 7 095 796 98 00/01

**SLOVAKIA**

HONEYWELL Ltd  
Mlynske nivy 73  
PO Box 75  
820 07 BRATISLAVA 27  
SLOVAKIA  
Tel. : 421 7 52 47 400/  
425

**SPAIN**

HONEYWELL S.A  
Factory  
Josefa Valcarcel, 24  
28027 MADRID  
SPAIN  
Tel. : 34 91 31 3 61 00

**SWEDEN**

HONEYWELL A.B.  
S-127 86 Skarholmen  
STOCKHOLM  
SWEDEN  
Tel. : 46 8 775 55 00

**SWITZERLAND**

HONEYWELL A.G.  
Hertistrasse 2  
8304 WALLISELLEN  
SWITZERLAND  
Tel. : 41 1 831 02 71

**TURKEY**

HONEYWELL  
Otomasyon ve Kontrol  
Sistemlen San ve Tic  
A.S.  
(Honeywell Turkey A.S.)  
Emirhan Cad No 144  
Barbaros Plaza C. Blok  
Kat 18  
Dikilitas 80700 Istanbul  
TURKEY  
Tel : 90-212 258 18 30

**UNITED KINGDOM**

HONEYWELL  
Unit 1,2 &4 Zodiac House  
Calleva Park  
Aldermaston  
Berkshire RG7 8HW  
UNITED KINGDOM  
Tel : 44 118 906 2600

**U.S.A.**

HONEYWELL INC.  
INDUSTRIAL PROCESS  
CONTROLS  
1100 VIRGINIA DRIVE  
PA 19034-3260  
FT. WASHINGTON  
U.S.A.  
Tel. : 1-800-343-0228

**VENEZUELA**

HONEYWELL CA  
APARTADO 61314  
1060 CARACAS  
VENEZUELA  
Tel. : 58 2 239 0211