

## **4909/4908 Style Conductivity Cells for 4909/04908 Series for CPVC Insertion/Removal Assembly Installation and Maintenance Manual**

70-82-25-19

Rev. 3

June 2009

---

# Copyright, Notices, and Trademarks

Printed in U.S.A. – © Copyright 2006 by Honeywell Inc.

Revision 3 – June 2009

While this information is presented in good faith and believed to be accurate, Honeywell disclaims the implied warranties of merchantability and fitness for a particular purpose and makes no express warranties except as may be stated in its written agreement with and for its customer.

In no event is Honeywell liable to anyone for any indirect, special or consequential damages. The information and specifications in this document are subject to change without notice.

Honeywell Process Solutions  
512 Virginia Drive  
Fort Washington, PA 19034

---

# About This Document

## Abstract

The purpose of this document is to support the installation operation and maintenance of the 4909/4908 Style Conductivity Cells for CPVC Insertion/Removal Assembly– Installation and Maintenance Manual.

## Revision Notes

The following list provides notes concerning all revisions of this document.

Rev. ID	Date	Notes
0	11/96	This revision is the initial release of the Honeywell version of the L&N manual p/n 277731 Rev. E1. There were no major changes to the L&N version when it was Honeywellized.
1	6/99	Edits were made to standardize terminology and to add the new Model Selection Guide
2	1/06	Edits to Maintenance, Spare Parts, and Wiring
3	June 09	Consolidation

## References

### Honeywell Documents

The following list identifies all Honeywell documents that may be sources of reference for the material discussed in this publication.

Document Title	Binder ID #
UDA2182 Dual Input Analyzer User Guide	70-82-25-119
UDA2182 Quick Start Guide	70-82-25-120
APT2000 Series Conductivity Transmitter	70-82-25-95
APT4000 Series Conductivity Analyzer	70-82-25-104

## Contacts

### World Wide Web

The following lists Honeywell's World Wide Web sites that will be of interest to our customers.

Honeywell Organization	WWW Address (URL)
Corporate	<a href="http://www.honeywell.com">http://www.honeywell.com</a>
Industrial Measurement and Control	<a href="http://www.honeywell.com/imc">http://www.honeywell.com/imc</a>

### Telephone








Contact us by telephone at the numbers listed below.

Organization	Phone Number
United States and Canada	Honeywell
	1-800-423-9883 Tech. Support
	1-800-525-7439 Service

---

## Symbol Definitions

The following table lists those symbols used in this document to denote certain conditions.

Symbol	Definition
	This CAUTION symbol on the equipment refers the user to the Product Manual for additional information. This symbol appears next to required information in the manual.
	<b>WARNING</b> <b>PERSONAL INJURY:</b> Risk of electrical shock. This symbol warns the user of a potential shock hazard where HAZARDOUS LIVE voltages greater than 30 Vrms, 42.4 Vpeak, or 60 Vdc may be accessible. <b>Failure to comply with these instructions could result in death or serious injury.</b>
	ATTENTION, Electrostatic Discharge (ESD) hazards. Observe precautions for handling electrostatic sensitive devices
	Protective Earth (PE) terminal. Provided for connection of the protective earth (green or green/yellow) supply system conductor.
	Functional earth terminal. Used for non-safety purposes such as noise immunity improvement. NOTE: This connection shall be bonded to protective earth at the source of supply in accordance with national local electrical code requirements.
	Earth Ground. Functional earth connection. NOTE: This connection shall be bonded to Protective earth at the source of supply in accordance with national and local electrical code requirements.
	Chassis Ground. Identifies a connection to the chassis or frame of the equipment shall be bonded to Protective Earth at the source of supply in accordance with national and local electrical code requirements.

---

# Contents

<b>1. INTRODUCTION .....</b>	<b>1</b>
1.1 Overview .....	1
1.2 4908 Conductivity Cell .....	1
1.3 31074357 Removal Device .....	2
<b>2. SPECIFICATIONS AND MODEL SELECTION GUIDE .....</b>	<b>7</b>
2.1 Specifications .....	7
<b>3. INSTALLATION .....</b>	<b>9</b>
3.1 Overview .....	9
3.2 Location and Position .....	9
3.3 Prepare Assembly .....	10
3.4 Insertion .....	11
3.5 Removal .....	12
<b>4. ELECTRICAL CONNECTIONS.....</b>	<b>15</b>
4.1 Overview .....	15
4.2 Instrument Wiring .....	16
4.2.1 Model 4909/4908 Series to UDA2182 Analyzer .....	16
4.2.2 Model 4909/4908 Series to APT2000/4000 series Analyzer .....	18
<b>5. MAINTENANCE AND REPLACEMENT PARTS .....</b>	<b>19</b>
5.1 Introduction .....	19
5.2 Cleaning the Cell .....	19
5.3 Platinizing the Cell Electrodes .....	19
5.4 Replacing Removal Device Parts .....	20
5.5 Replacement Parts .....	21

---

## Tables

Table 5-1 Voltage and Time Limits for Platinizing Cells _____	20
Table 5-2 Replacement Parts _____	21

## Figures

Figure 1-1 Temperature/Pressure Range _____	2
Figure 1-2 4909 CPVC Conductivity Cell Insertion/Removal Assembly with Conductivity Cell Installed	3
Figure 1-3 4909 CPVC Conductivity Cell Insertion/Removal Assembly with Universal Head _____	3
Figure 1-4 4908 Conductivity Cell _____	4
Figure 1-5 31074357 Removal Device _____	4
Figure 1-6 Universal Head _____	5
Figure 3-1 Outline and dimension drawing for Conductivity Cell, Insertion Type with CPVC removal Device with 20' cable _____	12
Figure 3-2 Outline and Dimension drawing for Conductivity Cell, Insertion Type with CPVC Removal Device and Universal Head _____	13
Figure 4-1 Installation Diagram, 4909/4908 Cells, with junction box head connected to UDA2182 Analyzer _____	16
Figure 4-2 Installation Diagram, 4909/4908 Cells, with 20' leads directly connected to UDA2182 Analyzer or connected to junction box _____	17
Figure 4-3 Model 4909/4908 Series to APT 2000/4000 Series Analyzer/Transmitter _____	18

---

# 1. Introduction

## 1.1 Overview

The 4909/4908 Style Conductivity Cells for CPVC Insertion/Removal Assembly is designed for use in a pipeline or closed vessel where it is desirable to remove the cell for inspection and maintenance without shutting down the system and releasing the pressure. The assembly comprises a 4908 Conductivity Cell and a 31074357 Removal Device which are shown assembled in Figure 1-2 and Figure 1-3. It is to be used in applications for which maximum pressure does not exceed 125 psig, and can be reduced to 50 psig during insertion and removal of the cell. Maximum operating temperature is determined by the temperature compensator range. Do not use in solutions above 80°C.

The conductivity cell is made from polyethersulfone (PES) with Ryton support fittings, which is resistant to most corrosive inorganic chemicals over a wide range of temperatures. (Common exceptions are chlorinated hydrocarbons and ketones.) Sample solutions come into contact with the PES and the platinum, nickel or Monel electrode surface of the cell. The only materials of the 4909 Assembly with which the sample solution may come into contact are in the removal device which is comprised of CPVC plastic, Teflon, EPDM and Viton materials. An automatic temperature compensator is built into the cell.

---

### ATTENTION

Conductivity Cells are manufactured with an embedded EEPROM that contains the cell constant and cell factor information. When the EEPROM leads (Brown and Blue) , junction box head terminals (E) and (F) are connected to a UDA2182 Analyzer these parameters are automatically uploaded into the analyzer.

---

### CAUTION

Specific parameters of your process may prohibit the use of nickel electrodes. For example, always use a platinum cell if the cell will measure or be exposed to regeneration acids or bases.

---

## 1.2 4908 Conductivity Cell

The molded conductivity cell and its one-inch diameter 3-inch long adapter comprise a one piece cell unit and are made of polyethersulfone (PES) and Ryton. This adapter serves as a stop during the removal operation. A 20' integral cable can be specified or the insertion/removal assembly can be supplied with a Junction Box Head, Figure 1-3 .

The cells having constants of 10 and 50 cm<sup>-1</sup> are intended for making measurements in highly conductive solutions. They differ in construction from those having constants of 0.01, 0.1, or 1. On the 10 and 50 constant cells, the electrodes are short tubes located midway inside the two parallel tubular channels that run lengthwise through the cell, and are open to the sample at both ends of the cell. The 0.01, 0.1 and 1.0 constant cells have a removable cell guard which is screwed onto the cell body to protect the electrode surfaces. Cells with a guard tube must be used with the guard in place or the cell constant may differ from that specified. Electrodes are three discs on the 1 constant cell, parallel plates on the 0.1 constant cell, and a pair of concentric wires wound on the cell body on the 0.01 constant cell.

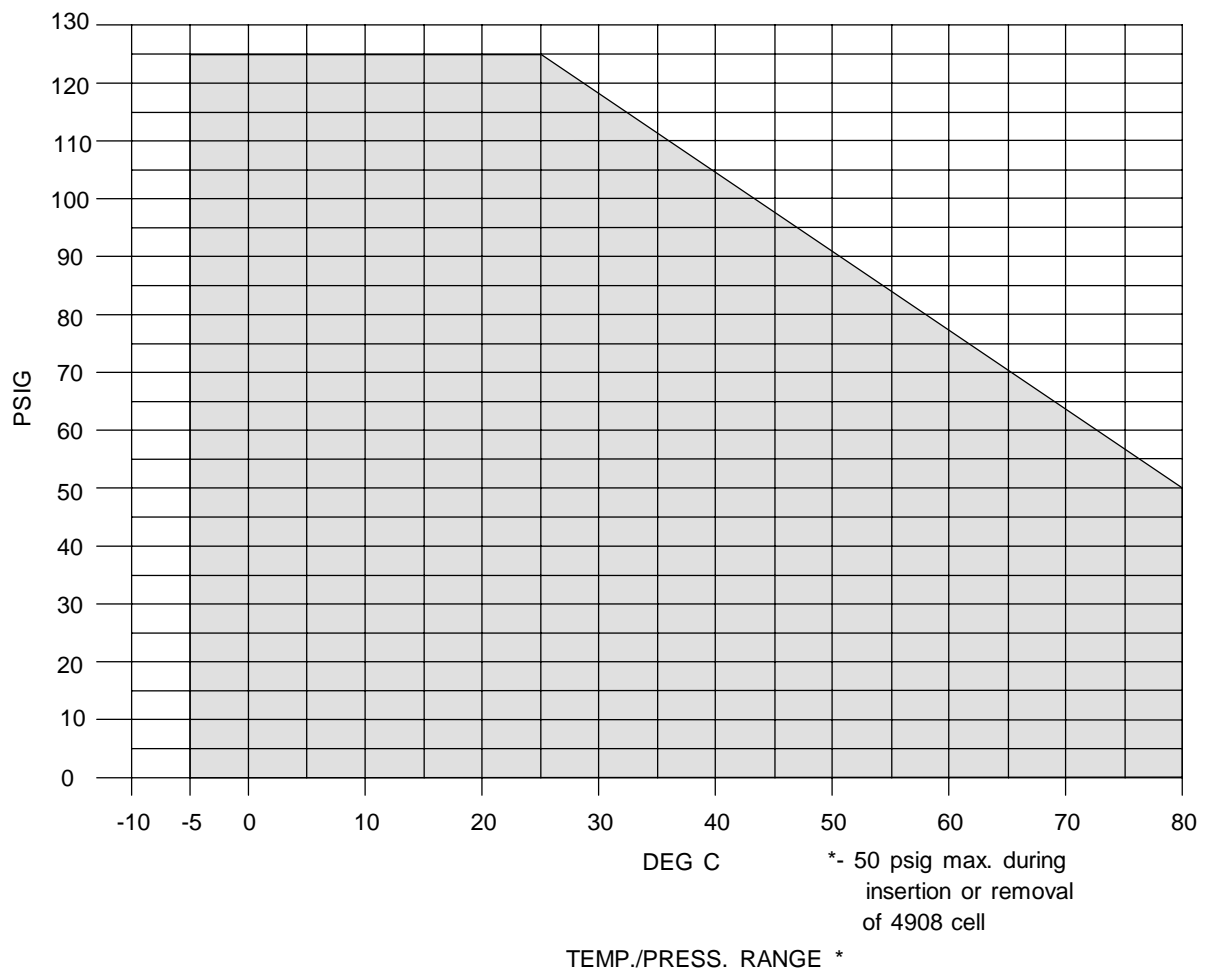
### 1.3 31074357 Removal Device

This device consists of a ball valve which is connected to the closed system by a 1-1/2 inch CPVC schedule 80 mounting nipple and to a housing by a 6 inch long schedule 80 CPVC nipple into which the support tube for the cell mounting is inserted. The compression handle provides a seal around the cell support tube.

Depending on the Key Number selected in Section 2.2 MSG, the 31074357 Removal Device may or may not include the 4908 Cell preinstalled in the device.

If Key Number 04908 is selected, the 4908 Cell (Figure 1-4) is shipped without the removal device.

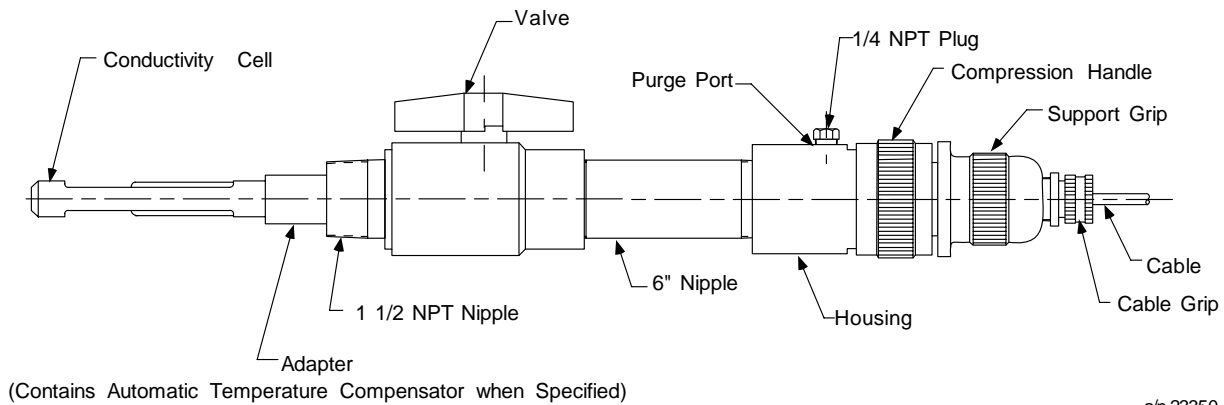
If Key Number 04909 is selected, the 4908 Cell is preinstalled into the removal device, Figure 1-3. Details of each type of installation are given in Section 3.3.



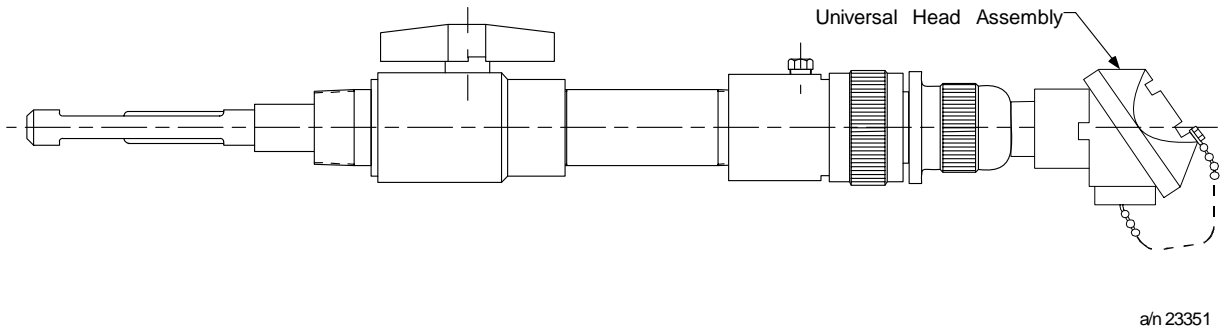
a/n 23349

Figure 1-1 Temperature/Pressure Range

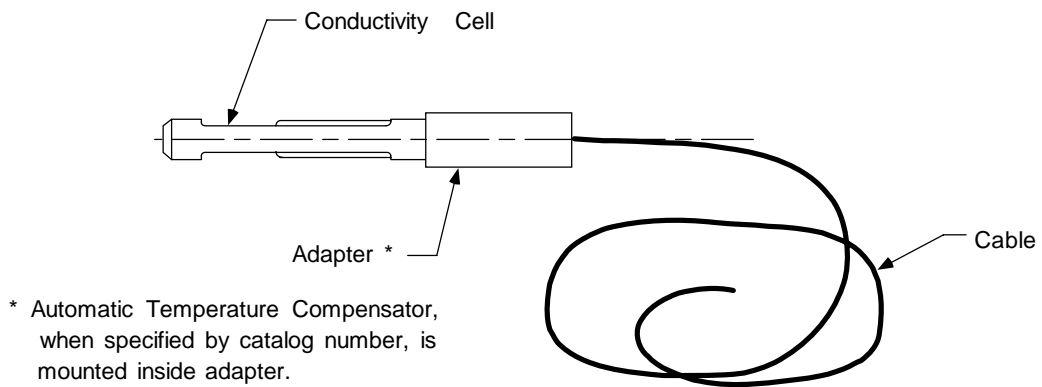




**Figure 1-2 4909 CPVC Conductivity Cell Insertion/Removal Assembly with Conductivity Cell Installed**

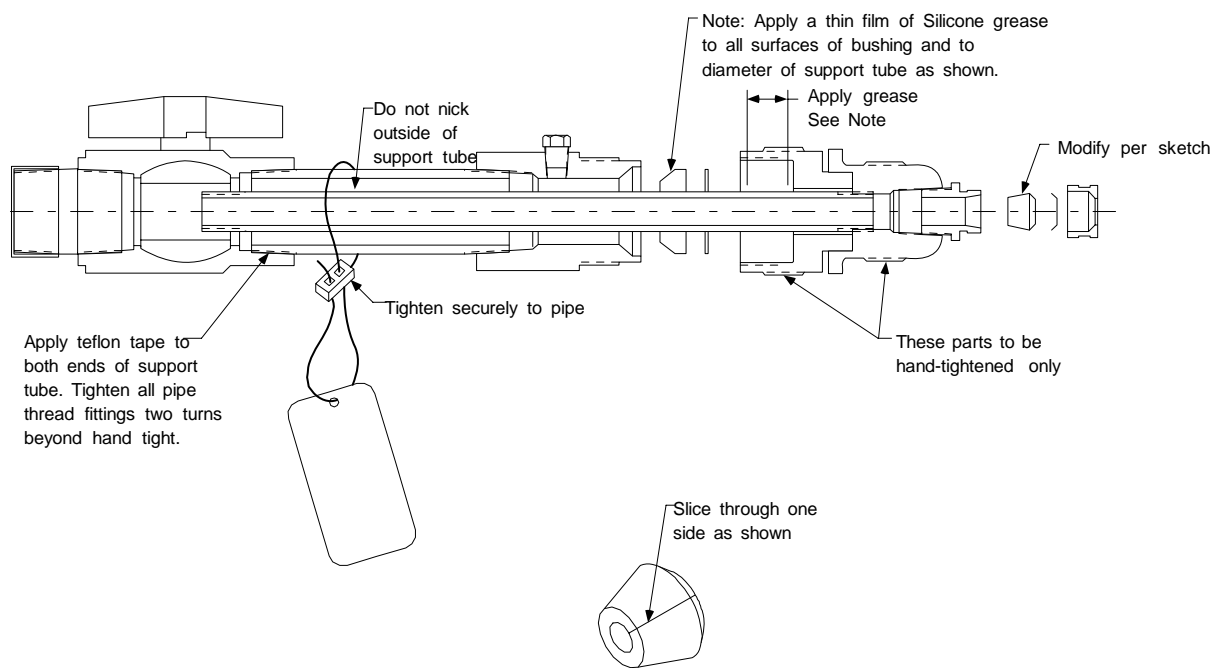


**Figure 1-3 4909 CPVC Conductivity Cell Insertion/Removal Assembly with Universal Head**



a/n 23352

Figure 1-4 4908 Conductivity Cell



a/n 23353

Figure 1-5 31074357 Removal Device

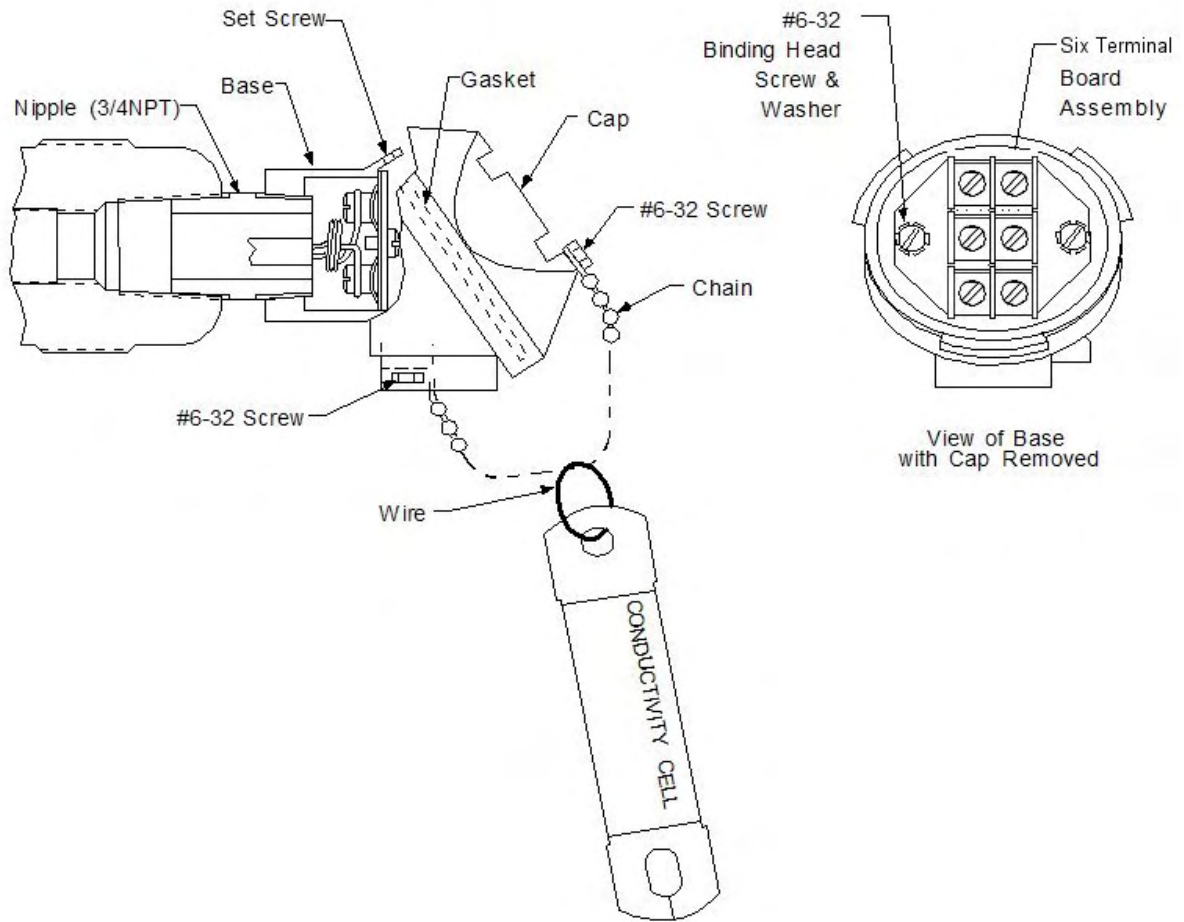


Figure 1-6 Universal Head



---

## 2. Specifications

### 2.1 Specifications

#### Cell Constants

0.01, 0.1, 1.0, 10 and 50 cm<sup>-1</sup>.

#### Electrode Material

Nickel, Platinum, or Monel as specified.

#### Wetted Parts

**Cell Body:** Polyethersulfone (PES), Ryton (PPS).

**Electrodes:** see above.

**Mounting Materials:** Chlorinated Polyvinyl Chloride (CPVC).

**Internal Sealing Materials:** Viton, Teflon & EPDM

#### Pressure and Temperature (See Figure 1-1)

125 psig (862 kPa) max. @ 23°F (-5°C)

90 psig (621 kPa) max. @ 122°F (50°C)

50 psig (345 kPa) max. @ 176°F (80°C)

#### Maximum Pressure

During Insertion or Removal: 50 psig.

#### Mounting

1-1/2" NPT male pipe. Overall length of removal device: approximately 20 or 22 inches (allow additional clearance for cell withdrawal). See Figure 3-1 and Figure 3-2.

#### Purge Port

1/4" NPT female opening.

#### Insertion Depth

Varies between 4.5" and 6.8" nominal, depending upon cell constant. Greater insertion depth optional. See Figure 3-1 and Figure 3-2.

#### Electrical Connections

Integral six lead cable or six point terminal junction box head.

## **Specifications**

---

### **Integral Automatic Temperature Compensation**

#### **Leadwire**

PVC covered, 22-gage cable, 20 feet, or Universal Head, as specified.

#### **Weight**

Approximately 3.5 lb (1.6 Kg) (including cell).

## 3. Installation

### 3.1 Overview

To insure that a representative sample is being measured at all times, the solution must move through and completely purge out the cell channels or guard tube. If the measurement is made in a rapidly moving liquid, the existing circulation of the solution can be utilized by mounting the assembly as described in the next section so that the flow of the solution forces liquid through the cell. However, when measurements are to be made in quiescent solutions, means must be provided for forcing the solution through the conductivity cell so no air bubbles accumulate or care taken to place the cell in a position to measure the true value of the solution.

Do not use the cells in solutions which will attack the fittings used or the wetted cell materials. The PES and platinum, nickel or Monel of the electrode are the cell materials with which the solution will come into contact. The wetted materials of the removal device with which the process may come into contact with are CPVC, Teflon, EPDM and Viton.

Do not use the cell in a solution having temperatures greater than 80°C. The maximum limit set by the temperature compensator range must be observed.

For cells having a constant of 0.01, 0.1 or 1, make certain that the guard is in place and is not loose on the cell body. The guard tube must be hand-tightened only. There is a 1/16 inch space between the guard tube and the cell body.

Do not install the 4909 Assembly where pressures and/or temperatures may occur outside the operating range given in Figure 1-1. Both pressure and temperature must be within the shaded area of the curve.

Avoid installations where the 4909 Assembly will be exposed to pressure shock caused by water hammer.

### 3.2 Location and Position

Refer to Figure 3-1 or Figure 3-2 for mounting dimensions.

The cross-channel in the high constant cells or the guard tube holes in the low constant cells must be covered by the solution during measurements.

Vertical insertion (from above) or horizontal insertion can be used. Make certain the tank or pipeline is full under all process conditions. If a pipeline is not always full, use a vertical mounting and insert the cell far enough into the vertical pipe that the cross-channel is below the horizontal exit pipe which may empty out. Make certain an air bubble in the pipe does not prevent the cell from filling properly. (If the cell becomes dry after use, it may require cleaning in accordance with Section 5.2 before again being placed in service.)

For best results, whether vertical or horizontal mounting is used, position the cell so that the sample will flow through the channels or guard tube towards the mounting end of the cell, exiting through the cross-channel or guard-tube holes. In applications where vertical mounting is required, avoid a position with the cell channels pointed up, as this will permit solution to flow down into the open end of the cell and may result in clogging by solids settling in the cell channels.

Allow for insertion depth from the outside wall of the mounting surface as indicated by the dimensions in Figure 3-1 or Figure 3-2.

Allow at least 1/2 inch clearance beyond the end of the cell and 1/8 to 3/16 inch radius clearance surrounding the cell to permit circulation of the solution.

Avoid locations where excessive temperature changes may occur.

Allow clearance behind the support grip to permit removal of the cell per dimensions in Figure 3-1 or Figure 3-2.

Locate the removal/insertion assembly on the pressure side of pumps; not the vacuum side.

Avoid locations where the operator must take an awkward position to perform the cell insertion or removal operation.

The 4909 Insertion/Removal Assembly is designed to support only its own weight. Do not install in locations where it would be used as a foot rest or where it would be used as a hand grip. Do not hang or support any other piping or objects from the assembly.

The removal device should not be mounted onto pipelines or vessels displaying excessive vibration unless a support is provided on the 6" long valve nipple.

### 3.3 Prepare Assembly

If the cell has a 20' cable, the 4908 Conductivity Cell (Figure 1-4) must be joined with the support tube of the 31074357 Removal Device as discussed in Section 1.3. Refer to Figure 1-5.

#### Initial Prep

1. Loosen compression handle by turning it counterclockwise until it is free from housing.
2. Withdraw the support tube, bushing, washer and handle assembly keeping the bushing and washer in place on the support tube. When greater insertion depth of the conductivity cell into the process solution is desired, p/n 31074344 Support Tube will give an additional 6 inches immersion beyond the standard depth. See Figure 3-1 and Figure 3-2. If 31074344 Support Tube is to be used, it must be secured to the support grip.
3. Slide the bushing and washer off of the standard support tube.
4. Turn the compression handle counterclockwise to remove it from the support grip.
5. Using a strap wrench, loosen and remove the standard support tube.
6. Install 31074344 Support Tube by wrapping one end with Teflon tape overlapping by 50% on each wrap. Wrap the tape in a clockwise direction as viewed from the threaded end of the support tube.
7. Thread this end into the support grip by hand and tighten an additional two turns by using a strap wrench. Do not use stillson or chain type wrenches as they may damage or score the support tube and prevent a good seal with the bushing.
8. Replace the compression handle, washer and bushing removed earlier. Note the proper orientation of the bushing with the tapered surface facing away from the compression handle.

#### Mounting into the Process

The valve nipples and housing can now be mounted into the process pipeline or tank wall.

1. Remove the protective cap and apply Teflon tape to mounting nipple. Wrap the tape on the threads in a clockwise direction as viewed from the threaded end. Overlap the tape by 50% on each wrap. Cover the threaded area twice in this manner.
2. Install the mounting nipple and valve assembly hand tight.
3. Using a strap wrench on the mounting nipple, tighten the assembly an additional 1-1/2 to 2 turns. Do not use stillson or chain type wrenches as they may damage and weaken the CPVC plastic. Do not use the valve handle for leverage.



4. Close the ball valve; handle perpendicular to valve.

A purge port is provided on the removal device housing. Water or some other fluid source can be piped to this port for the purpose of cleaning out the valve assembly from accumulated debris. For most conductivity applications, the process stream will not have high particle content and the purge port is not used.

If purging is required remove plug and install a purge line to the 1/4 NPT opening. Note that the purge fluid temperature and pressure must not exceed the 4909 Assembly temperature and pressure specifications as shown in Figure 1-1. Also, the purge line must have a shutoff valve located near the removal device.

Another use for the purge port can be realized if a pressure gage is installed in the 1/4 NPT opening. It will serve as a local indication of process pressure to confirm that the pressure is below 50 psig during insertion or removal of the cell.

Make sure the bushing and washer are in place on the support tube, then feed the cable of the 4908 Conductivity Cell through the support tube and turn the tube hand tight onto the conductivity cell. Using a strap wrench, tighten the 4908 Cell an additional 1-1/2 to 2 turns. Do not score or gouge the support tube surface because the bushing makes a seal on the tube surface.

Tighten the cable grip to provide strain relief from the cell cable.

If X1 is selected in Table IV of the Model Selection Guide, then the 4908 Conductivity Cell has been pre-mounted by Honeywell onto the support tube. Also cable wiring to the universal head terminal board has been completed. The valve assembly can then be mounted to the process by following steps under “Mounting into the Process” mentioned earlier.

### 3.4 Insertion



1. Make sure the bushing and washer (Figure 1-5) are in place on the support tube. A thin film of silicone grease is applied at the factory to the bushing and to the support tube area covered by the compression handle. If this film has been wiped off or if dirt or grit is present, clean these areas and reapply a new film of silicone grease.
2. Obtain the cell and support tube assembly prepared earlier. Separate the compression handle from the support grip by turning the support grip counterclockwise approximately two turns. Slide the compression handle along the support tube until the bushing and washer are sandwiched between the handle and 4908 Cell Adapter.
3. Slide the cell and tube assembly into the removal device housing and tighten the compression handle clockwise until drag is felt on the tube. This can be determined by rotating the tube by hand.
4. **REDUCE PROCESS PRESSURE TO 50 PSIG OR LESS.** Open the ball valve; handle parallel to valve.
5. Push the cell and support tube assembly all the way in using the support grip.
6. Tighten the support grip by turning clockwise two turns. (continued)

#### ATTENTION

This step is important to prevent blow-back of cell and support tube assembly. The bushing acts as a safety stop against the cell adapter if the support tube does blow back.

7. Return the process to normal operating pressure.
8. Further tighten the compression handle if leakage occurs from the bushing seal area.

### 3.5 Removal

1.  **REDUCE PROCESS PRESSURE TO 50 PSIG OR LESS.**  
Shut off purge line, if used. Disconnect wiring connections if MSG option = 1.
2.  **DO NOT STAND BEHIND THE TUBE WHEN PERFORMING THIS STEP.**  
While holding the compression handle from turning, turn the support grip two turns counterclockwise. Loosen the compression handle until the process pressure pushes the cell and support tube assembly out to its internal stop. If necessary, pull out by hand until stop is reached.
3. Close the ball valve. If the valve does not close easily, make sure the support tube is pulled all the way back.
4. Completely loosen the compression handle to withdraw the cell.

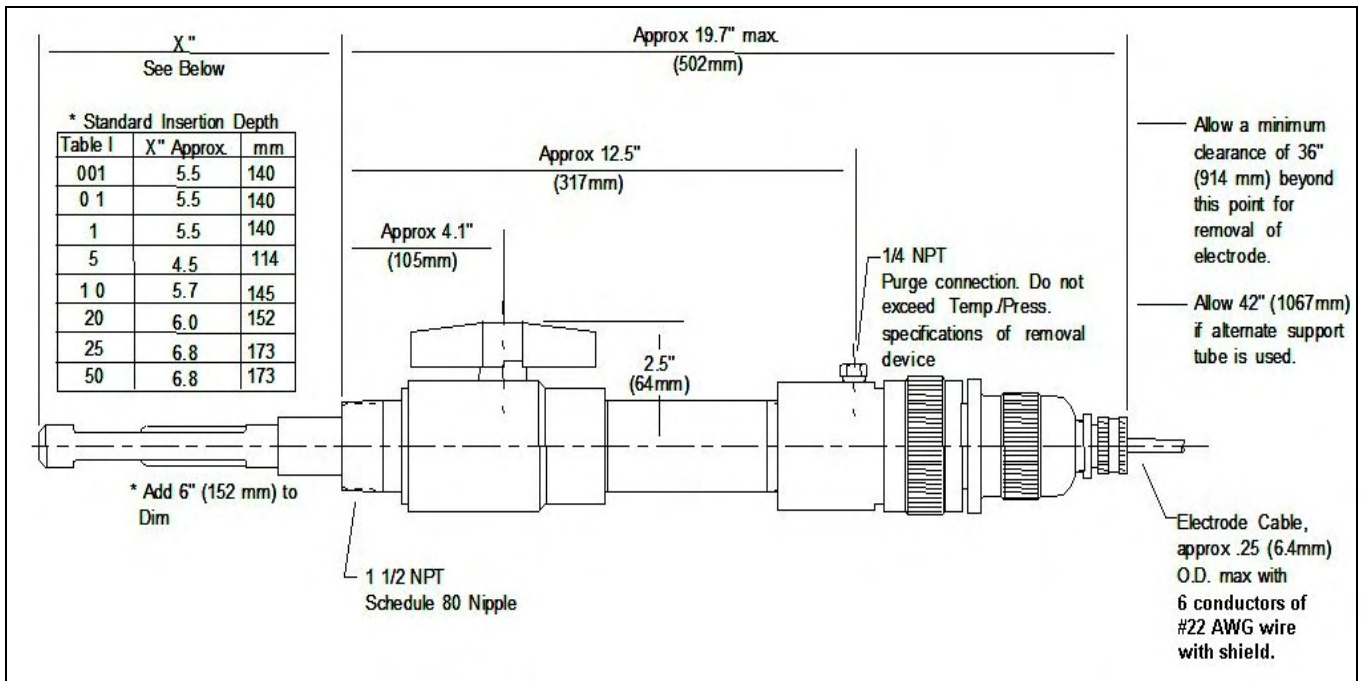


Figure 3-1 Outline and dimension drawing for Conductivity Cell, Insertion Type with CPVC removal Device with 20' cable

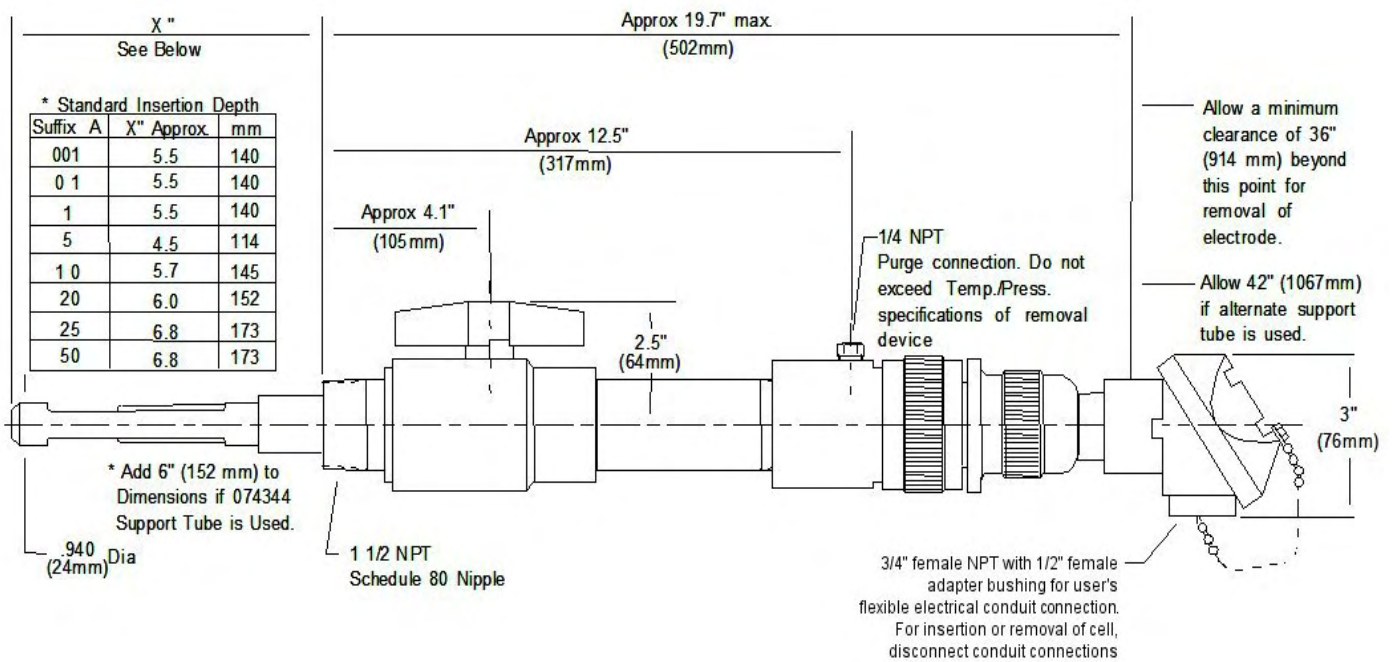


Figure 3-2 Outline and Dimension drawing for Conductivity Cell, Insertion Type with CPVC Removal Device and Universal Head



## 4. Electrical Connections

### 4.1 Overview

The terminal board connections for recorder or analyzer are given in the appropriate directions furnished with the measuring instrument.

To avoid the possibility of ac pick-up in the cell leads, separate them from all AC line voltage wiring or run them in a separate grounded conduit.

Cells are available with leadwire of 20 feet. For distances greater than 20 feet, use the required length of cable and a junction box, as noted in the Wiring Diagrams. For assemblies supplied with a Universal Head, Figure 3-2, a junction box is not required.



#### **WARNING**

For 6 conductor cells, EEPROM memory device is ESD sensitive- blue and brown leads; junction box head terminals (D) and (E)

---

## 4.2 Instrument Wiring

### 4.2.1 Model 4909/4908 Series to UDA2182 Analyzer

Drawing 50043652

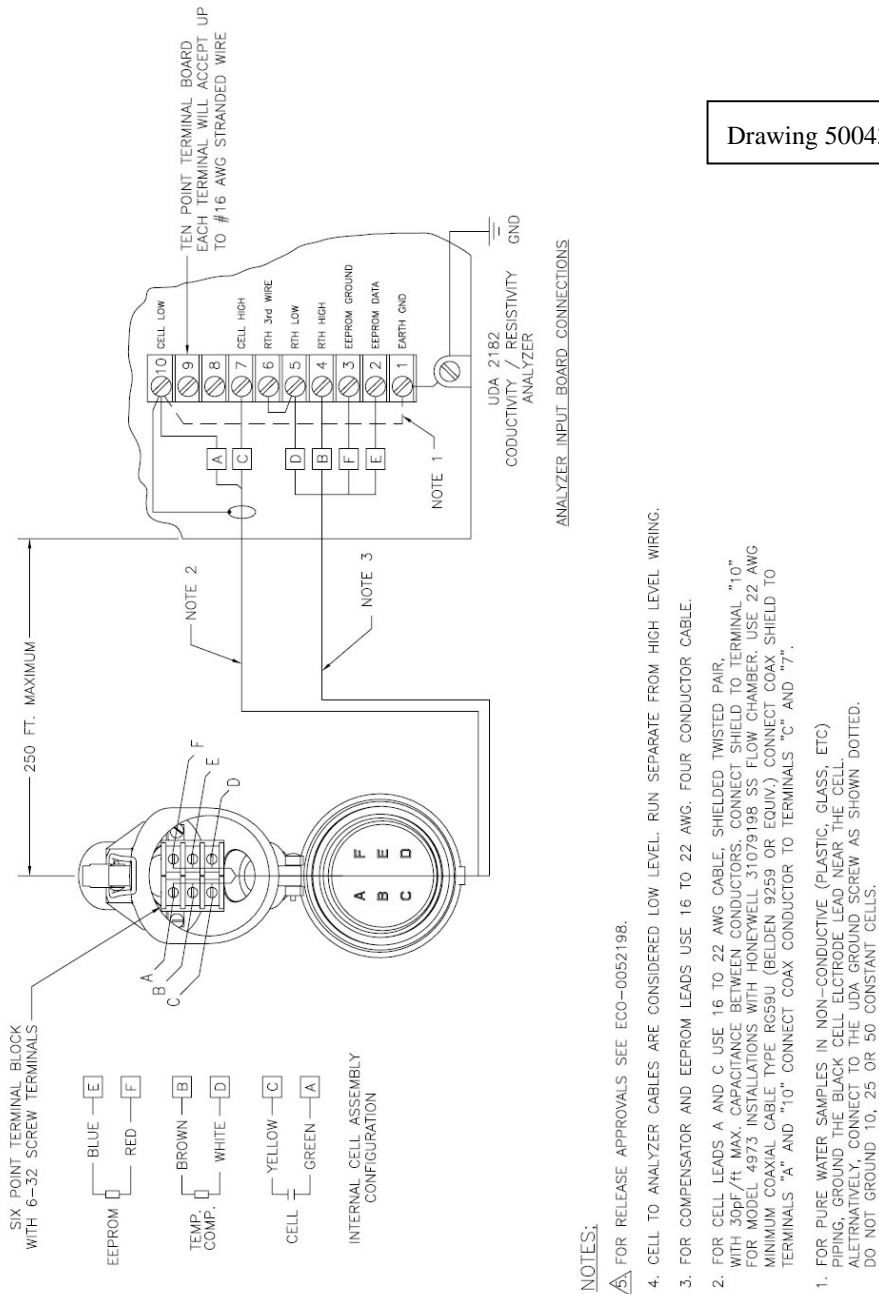


Figure 4-1 Installation Diagram, 4909/4908 Cells, with junction box head connected to UDA2182 Analyzer

Drawing 50043654

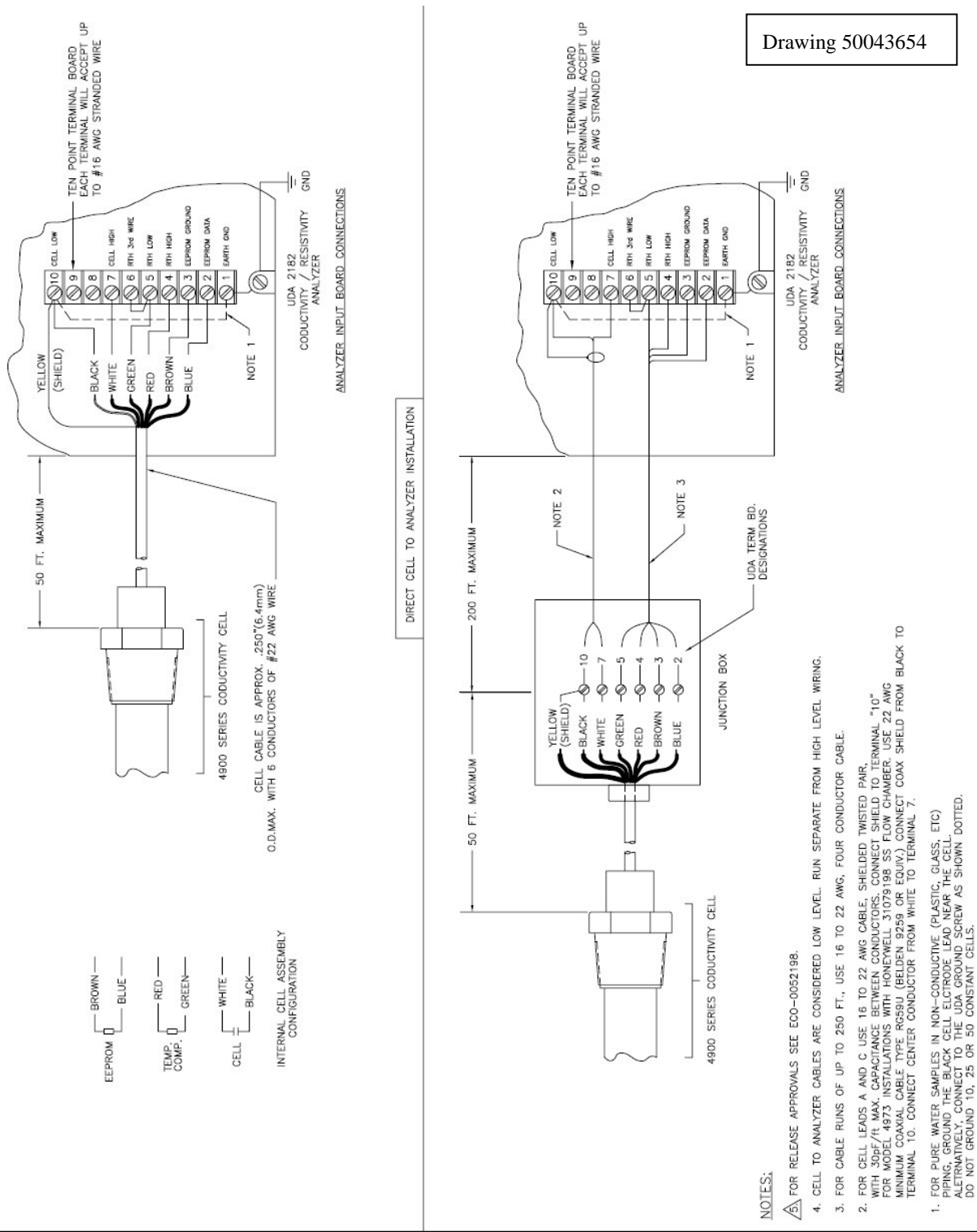
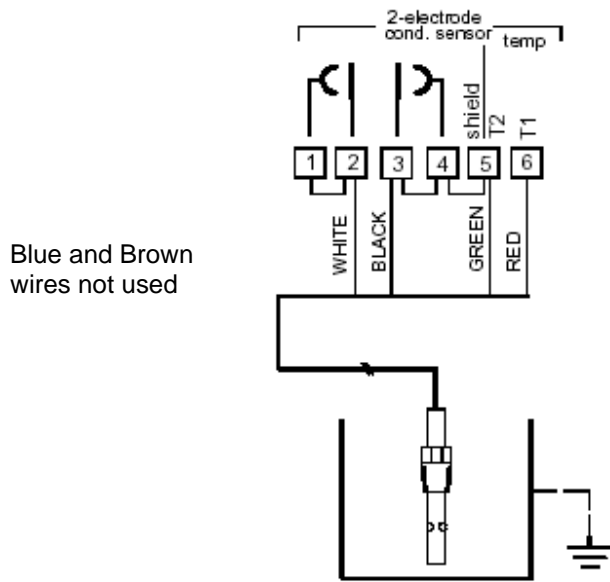
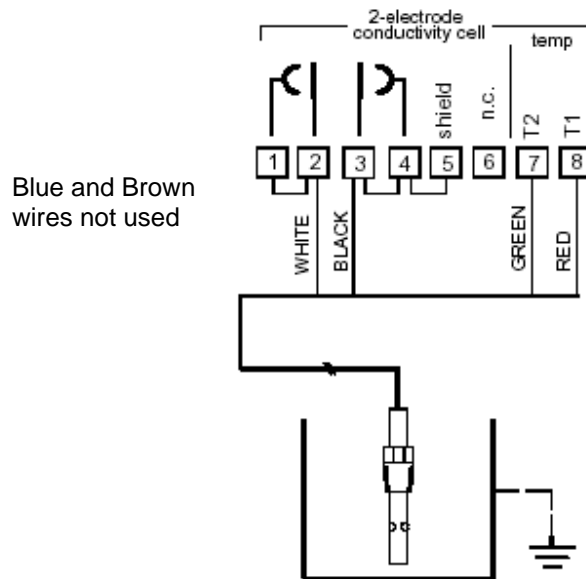


Figure 4-2 Installation Diagram, 4909/4908 Cells, with 20' leads directly connected to UDA2182 Analyzer or connected to junction box

### 4.2.2 Model 4909/4908 Series to APT2000/4000 series Analyzer



04909/4908 series cells with 20' leads connected to an APT4000



04909/4908 series cells with or 20' leads connected to an APT2000

Figure 4-3 Model 4909/4908 Series to APT 2000/4000 Series Analyzer/Transmitter



## 5. Maintenance and Replacement Parts

### 5.1 Introduction

If a series of below normal conductivity readings or above normal resistivity readings occur, this may indicate that the cell is not filled with process solution. Check the cell installation. Refer to Sections 3.1 and 3.2.

The only maintenance which may be required is occasional cleaning in certain applications. The 0.01, 0.1, and 1.0 cm<sup>-1</sup> low constant electrodes are not platinized.

**NOTE: Never connect a test instrument across the Blue (E) and Brown (F) leads. Damage to the cell memory device may occur.**

### 5.2 Cleaning the Cell

---

**CAUTION**

The cell assembly is PES (polyethersulfone). Do not clean with acetone, chloroform, toluene, benzene, or any chlorinated hydrocarbon.

---

The cell will require cleaning if sludge, slime, etc., accumulates in the flow channels. Since the materials of construction are chemically inert, chemical agents may be used and are recommended for cleaning the cells. The particular cleaning agent used must be selected according to the type of contamination to which the cell is exposed. In general, soap and hot water cleaning solution is effective. Immerse the plastic body of the cell in this solution. A 10 or 15 minute soaking period should be adequate. If necessary, a soft bristle brush of appropriate diameter may be used to clean out the tubular channels of the 10 and 50 constant cells. Care must be taken not to scratch the electrode surfaces. Do not use a brush on the low (0.01, 0.1 and 1) constant cells and be especially careful not to bend the electrode plates of the 0.1 constant cell. Rinse the cell thoroughly in tap water and then in distilled water if available. To remove the platinum black from electrodes (10 and 50 constants only), refer to Section 5.3. Replatinizing after each cleaning (10 and 50 constant cells only) may not be necessary unless brushing was used.

### 5.3 Platinizing the Cell Electrodes

Only the electrodes having constants from 10 to 50 must be replatinized if the velvety-black deposit has been rubbed off the electrodes in service or in cleaning or if platinized electrodes are recommended and this black deposit is not present when the new cell is received. Always replatinize if a brush was used in cleaning the electrodes. The indication of a need for replatinization of the electrodes is loss in sensitivity (slow response of measuring instrument), erratic behavior of measuring instrument, or difficulty in balancing. The electrodes of the high constant cells are not visible since they are located near the middle of the flow channels. Therefore the need for platinization is only indicated by the effect on the measuring instrument. Do not platinize cells intended for high purity water measurements.

Before platinizing, clean the cell with detergent and brush as described in Section 5.2.

Support the cell in a cylindrical vessel with the end of the cell raised from the bottom. It is not necessary to remove the cell from the fittings for platinizing. However, the guard tube must be removed from the low constant cells. Pour in a platinizing solution to a level above the cross-channel.

To platinize the 10 or 50 constant cells, immerse an auxiliary platinum electrode in the solution to a point about midway between the cross-channel or tube hole and the open end of the cell. (This third electrode should be chemically pure platinum. Its shape is unimportant. It may be one of the electrodes in another conductivity cell or a platinum strip, sheet, rod, wire, etc.) Both electrodes of the cell are platinized simultaneously by connecting the negative terminal of the battery (see Table 5-1 Voltage and Time Limits for Platinizing Cells) to both leadwires of the cell. Connect the positive terminal of the battery to the auxiliary platinum electrode. Note the time lapse and continue the platinizing operation for the time in seconds listed in Table 5-1. Then disconnect the battery and remove the cell. Rinse the cell thoroughly in tap water and then rinse in distilled water. During the platinizing operation, move the cell up and down gently to keep the solution stirred.

---

### CAUTION

The preceding procedure produces a barely visible coating of platinum black on the electrode surfaces. Do not attempt to darken electrodes by additional platinization since this will affect the cell performance adversely.

---

Pour the platinizing solution back into its container as it may be used a number of times.

If the cell is not to be installed immediately after platinizing, it should be kept submerged in distilled water until put into use, as platinum black is not stable when dry.

**Table 5-1 Voltage and Time Limits for Platinizing Cells**

DC Volts	10	50
6.0	100 sec.	300 sec.
12.0	----	240 sec.

## 5.4 Replacing Removal Device Parts

### Ball Valve

If a new ball valve is installed, orient the valve body so that the heavy walled end is toward the process connection for added support strength. See Teflon tape note below.

### Nipples

If nipples are replaced, use exact replacement to ensure pressure and temperature ratings, proper immersion length and proper operation of removal device.

Use only Teflon tape on all valve, nipple and support tube pipe threads. Other liquid or paste sealants may contain solvents that weaken the CPVC material.

**Bushing and Washer**

Replace these parts if swollen, cracked or damaged in a way that prevents a good seal on the support tube. Lightly grease the new bushing with silicone grease before installing.

Note that the support grip must be removed from the support tube before replacing the bushing and/or washer. Orient the bushing so that the tapered surface faces away from the compression handle, Figure 1-5.

**5.5 Replacement Parts**

**Table 5-2 Replacement Parts**

Description	Part Number
Complete CPVC Removal Device	31074357
Support Tube, 1/2" NPT Sch. 80, CPVC (12" Immersion)	31074344
Support Tube, 1/2" NPT Sch. 80, CPVC (6" Immersion)	31074343
Junction Box	31316260
Extension Cable must be purchased from Honeywell	
<b>Cell Extension Leadwire (see Fig 4.1 &amp; 4.2 for required cables)</b>	
18 AWG, Low capacitance shielded twisted pair	BELDEN 8760 or equivalent
22 AWG, Coax RG59U	BELDEN 9259 or equivalent
18 AWG, 4 conductor	BELDEN 8489 or equivalent

# Honeywell

---

**Honeywell Process Solutions**

512 Virginia Drive

Fort Washington, PA 19034

70-82-25-19 June 09 Printed in USA

[www.honeywell.com/ps](http://www.honeywell.com/ps)